

Applications

- Military radar
- Civilian radar
- Professional and military radio communications
- Test instrumentation
- Wideband or narrowband amplifiers
- Jammers



Product Features

- Frequency: DC to 3.5 GHz
- Output Power (P_{3dB}): 107 W at 3.5 GHz
- Linear Gain: > 14 dB at 3.5 GHz
- Typical PAE: > 50% at 3.5 GHz
- Operating Voltage: 28 V
- Low thermal resistance package

Functional Block Diagram

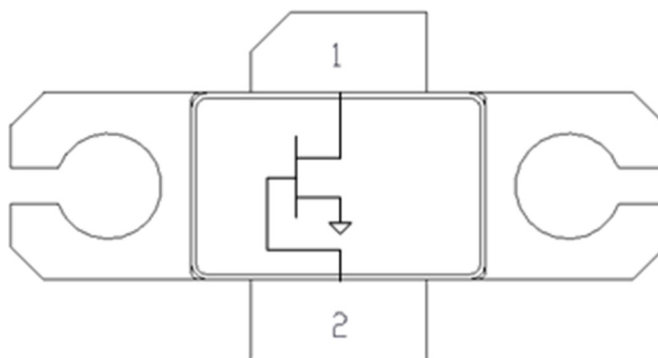

General Description

The TriQuint TGF2929-FL is a 107 W (P_{3dB}) discrete GaN on SiC HEMT which operates from DC to 3.5 GHz. The device is constructed with TriQuint's proven TQGaN25HV process, which features advanced field plate techniques to optimize power and efficiency at high drain bias operating conditions. This optimization can potentially lower system costs in terms of fewer amplifier line-ups and lower thermal management costs.

Lead-free and ROHS compliant

Evaluation boards are available upon request.

Pin Configuration

Pin No.	Label
1	V_D / RF OUT
2	V_G / RF IN
Flange	Source

Ordering Information

Part	ECCN	Description
TGF2929-FL	EAR99	Packaged part Flangeless
TGF2929-FL-EVB1	EAR99	3.1-3.5 GHz Evaluation Board

Absolute Maximum Ratings

Parameter	Value
Breakdown Voltage (V_{D0})	145 V min.
Gate Voltage Range (V_G)	-10 to 0 V
Drain Current (I_D)	12 A
Gate Current (I_G)	-28.8 to 33.6 mA
Power Dissipation (P_D)	144 W
RF Input Power, CW, $T = 25^\circ\text{C}$ (P_{IN})	39.8 dBm
Channel Temperature (T_{CH})	275 $^\circ\text{C}$
Mounting Temperature (30 Seconds)	320 $^\circ\text{C}$
Storage Temperature	-40 to 150 $^\circ\text{C}$

Operation of this device outside the parameter ranges given above may cause permanent damage. These are stress ratings only, and functional operation of the device at these conditions is not implied.

Recommended Operating Conditions

Parameter	Value
Drain Voltage (V_D)	28 V (Typ.)
Drain Quiescent Current (I_{DQ})	260 mA (Typ.)
Peak Drain Current, Pulse (I_D)	7.23 A (Typ.)
Gate Voltage (V_G)	-2.9 V (Typ.)
Channel Temperature (T_{CH})	250 $^\circ\text{C}$ (Max.)
Power Dissipation, CW (P_D)	82 W (Max)
Power Dissipation, Pulse (P_D)	140 W (Max)

Electrical specifications are measured at specified test conditions. Specifications are not guaranteed over all recommended operating conditions.

Pulse signal: 100uS Pulse Width, 20% Duty Cycle

RF Characterization – Load Pull Performance at 1 GHz ⁽¹⁾

Test conditions unless otherwise noted: $T_A = 25^\circ\text{C}$, $V_D = 28\text{ V}$, $I_{DQ} = 260\text{ mA}$

Symbol	Parameter	Min	Typical	Max	Units
G_{LIN}	Linear Gain (Power Tuned)		21.2		dB
P_{3dB}	Output Power at 3 dB Gain Compression (Power Tuned)		100		W
PAE_{3dB}	Power-Added Efficiency at 3 dB Gain Compression (Eff. Tuned)		75.7		%
G_{3dB}	Gain at 3 dB Compression (Power Tuned)		18.2		dB

Notes:

1. Pulse: 100 μs , 20%

RF Characterization – Load Pull Performance at 2 GHz ⁽¹⁾

Test conditions unless otherwise noted: $T_A = 25^\circ\text{C}$, $V_D = 28\text{ V}$, $I_{DQ} = 260\text{ mA}$

Symbol	Parameter	Min	Typical	Max	Units
G_{LIN}	Linear Gain (Power Tuned)		16.7		dB
P_{3dB}	Output Power at 3 dB Gain Compression (Power Tuned)		132		W
PAE_{3dB}	Power-Added Efficiency at 3 dB Gain Compression (Eff. Tuned)		64.4		%
G_{3dB}	Gain at 3 dB Compression (Power Tuned)		13.7		dB

Notes:

1. Pulse: 100 μs , 20%

RF Characterization – Load Pull Performance at 3.0 GHz ⁽¹⁾

Test conditions unless otherwise noted: $T_A = 25\text{ °C}$, $V_D = 28\text{ V}$, $I_{DQ} = 260\text{ mA}$

Symbol	Parameter	Min	Typical	Max	Units
G_{LIN}	Linear Gain (Power Tuned)		15.6		dB
P_{3dB}	Output Power at 3 dB Gain Compression (Power Tuned)		120		W
PAE_{3dB}	Power-Added Efficiency at 3 dB Gain Compression (Eff. Tuned)		65.5		%
G_{3dB}	Gain at 3 dB Compression (Power Tuned)		12.6		dB

Notes:

1. Pulse: 100 μ s, 20%

RF Characterization – Load Pull Performance at 3.5 GHz ⁽¹⁾

Test conditions unless otherwise noted: $T_A = 25\text{ °C}$, $V_D = 28\text{ V}$, $I_{DQ} = 260\text{ mA}$

Symbol	Parameter	Min	Typical	Max	Units
G_{LIN}	Linear Gain (Power Tuned)		15.8		dB
P_{3dB}	Output Power at 3 dB Gain Compression (Power Tuned)		107		W
PAE_{3dB}	Power-Added Efficiency at 3 dB Gain Compression (Eff. Tuned)		58.4		%
G_{3dB}	Gain at 3 dB Compression (Power Tuned)		12.8		dB

Notes:

1. Pulse: 100 μ s, 20%

RF Characterization – Performance at 3.3GHz ^(1, 2)

Test conditions unless otherwise noted: $T_A = 25\text{ }^\circ\text{C}$, $V_D = 28\text{ V}$, $I_{DQ} = 260\text{ mA}$

Symbol	Parameter	Min	Typical	Max	Units
G_{LIN}	Linear Gain		15.0		dB
P_{3dB}	Output Power at 3 dB Gain Compression		106		W
PAE_{3dB}	Power-Added Efficiency at 3 dB Gain Compression		51.3		%
G_{3dB}	Gain at 3 dB Compression		12.0		dB

Notes:

1. Pulse: 100 μ s PW, 20%
2. Performance at 3.3GHz in the 3.1 to 3.5GHz Evaluation Board

RF Characterization – Mismatched Ruggedness at 3.50 GHz ^(1, 2)

Test conditions unless otherwise noted: $T_A = 25\text{ }^\circ\text{C}$, $V_D = 28\text{ V}$, $I_{DQ} = 260\text{ mA}$

Symbol	Parameter	Typical
VSWR	Impedance Mismatch Ruggedness	10:1

Notes:

1. Input power established at P3dB at matched load at the output of 3.1 – 3.5 GHz Evaluation Board
2. Pulse: 100 μ s PW, 20%

Thermal and Reliability Information - Pulsed

Parameter	Test Conditions	Value	Units
Thermal Resistance ⁽¹⁾ (θ_{JC})	100uS, 5%, Pdiss = 100W	0.75	°C/W
Channel Temperature (T_{CH})		160	°C
Median Lifetime (T_M)		1.92E09	Hours
Thermal Resistance ⁽¹⁾ (θ_{JC})	100uS, 10%, Pdiss = 100W	0.79	°C/W
Channel Temperature (T_{CH})		164.3	°C
Median Lifetime (T_M)		1.24E09	Hours
Thermal Resistance ⁽¹⁾ (θ_{JC})	300uS, 20%, Pdiss = 100W	0.88	°C/W
Channel Temperature (T_{CH})		173	°C
Median Lifetime (T_M)		5.13E08	Hours
Thermal Resistance ⁽¹⁾ (θ_{JC})	300uS, 50%, Pdiss = 100W	1.15	°C/W
Channel Temperature (T_{CH})		200	°C
Median Lifetime (T_M)		4.20E07	Hours

Notes:

1. Thermal resistance measured to bottom of package.

Thermal and Reliability Information - CW ¹

Parameter	Test Conditions	Value	Units
Thermal Resistance (θ_{JC})	85 °C Case 28.8 W Pdiss	0.87	°C/W
Channel Temperature (T_{CH})		110	°C
Median Lifetime (T_M)		6.38E11	Hrs
Thermal Resistance (θ_{JC})	85 °C Case 57.6 W Pdiss	1.49	°C/W
Channel Temperature (T_{CH})		171	°C
Median Lifetime (T_M)		6.29E8	Hrs
Thermal Resistance (θ_{JC})	85 °C Case 86.4 W Pdiss	1.62	°C/W
Channel Temperature (T_{CH})		225	°C
Median Lifetime (T_M)		5.49E6	Hrs
Thermal Resistance (θ_{JC})	85 °C Case 115.2 W Pdiss	1.74	°C/W
Channel Temperature (T_{CH})		285	°C
Median Lifetime (T_M)		7.80E4	Hrs

Notes:

1. Thermal resistance measured to bottom of package.

Median Lifetime

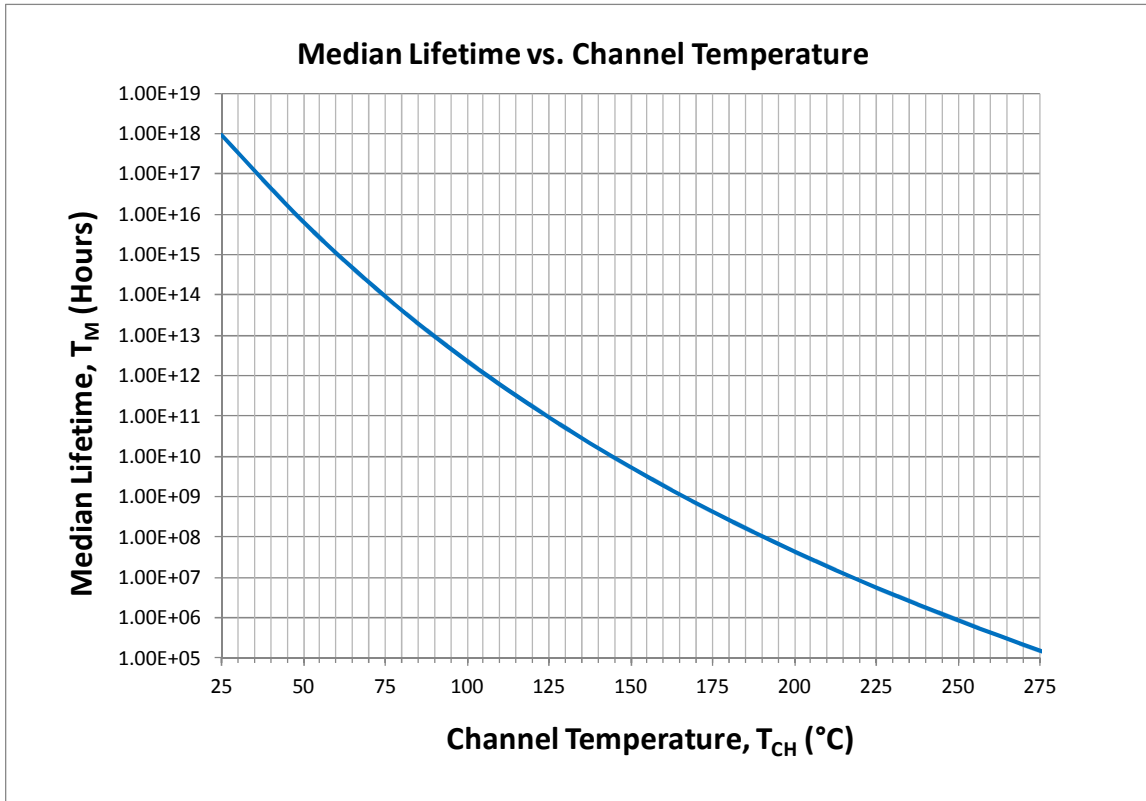

Maximum Channel Temperature - Pulsed

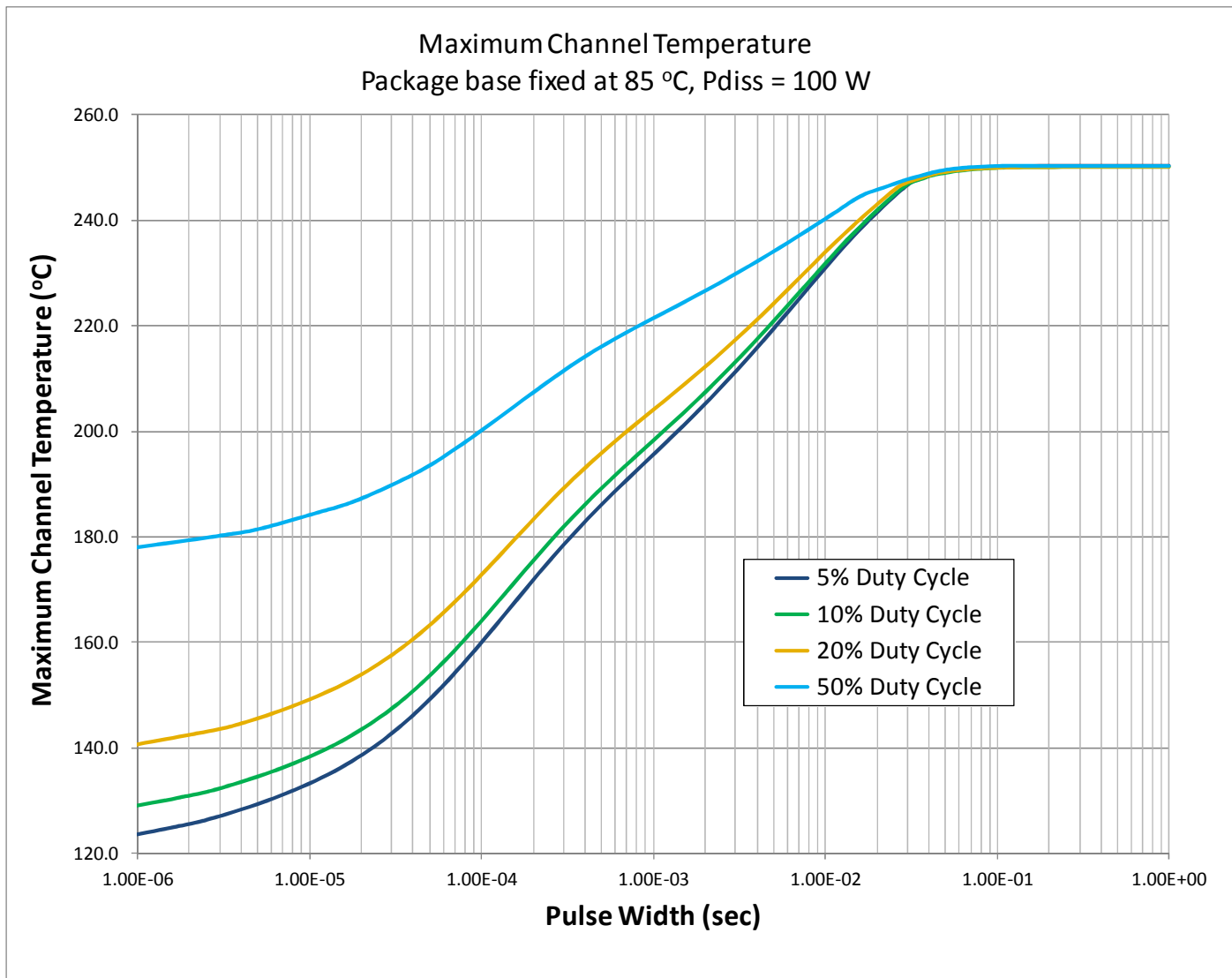

Load Pull Smith Charts (1, 2)

RF performance that the device typically exhibits when placed in the specified impedance environment. The impedances are not the impedances of the device, they are the impedances presented to the device via an RF circuit or load-pull system. The impedances listed follow an optimized trajectory to maintain high power and high efficiency at reference planes indicated on page 18.

Notes:

1. Test Conditions: $V_{DS} = 28\text{ V}$, $I_{DQ} = 260\text{ mA}$
2. Test Signal: Pulse Width = 100 μsec , Duty Cycle = 20%
3. NaN indicates the harmonic impedances are uncontrolled.

1GHz, Load-pull

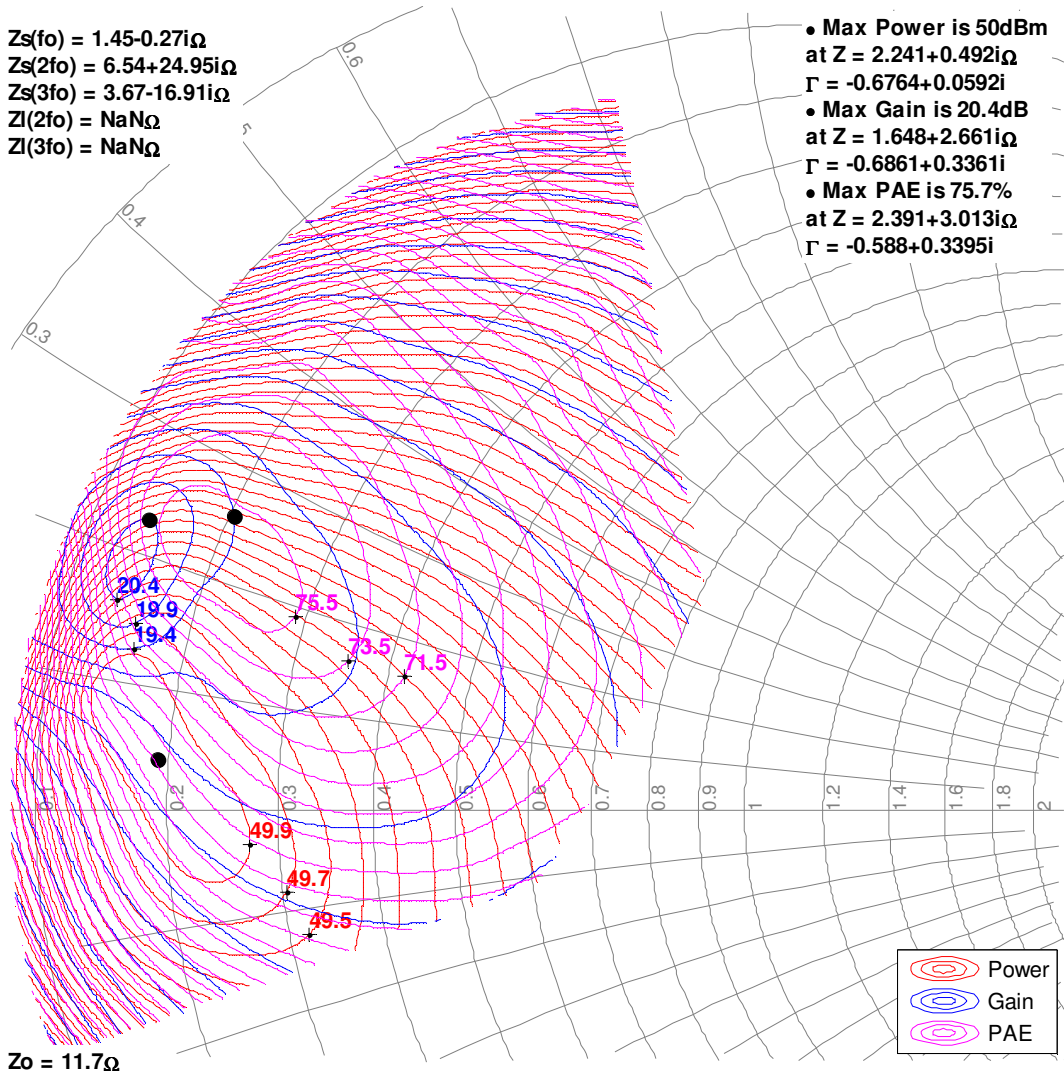

Load Pull Smith Charts (1, 2)

RF performance that the device typically exhibits when placed in the specified impedance environment. The impedances are not the impedances of the device, they are the impedances presented to the device via an RF circuit or load-pull system. The impedances listed follow an optimized trajectory to maintain high power and high efficiency at reference planes indicated on page 18.

Notes:

1. Test Conditions: $V_{DS} = 28\text{ V}$, $I_{DQ} = 260\text{ mA}$
2. Test Signal: Pulse Width = 100 μsec , Duty Cycle = 20%
3. NaN indicates the harmonic impedances are uncontrolled.

2GHz, Load-pull

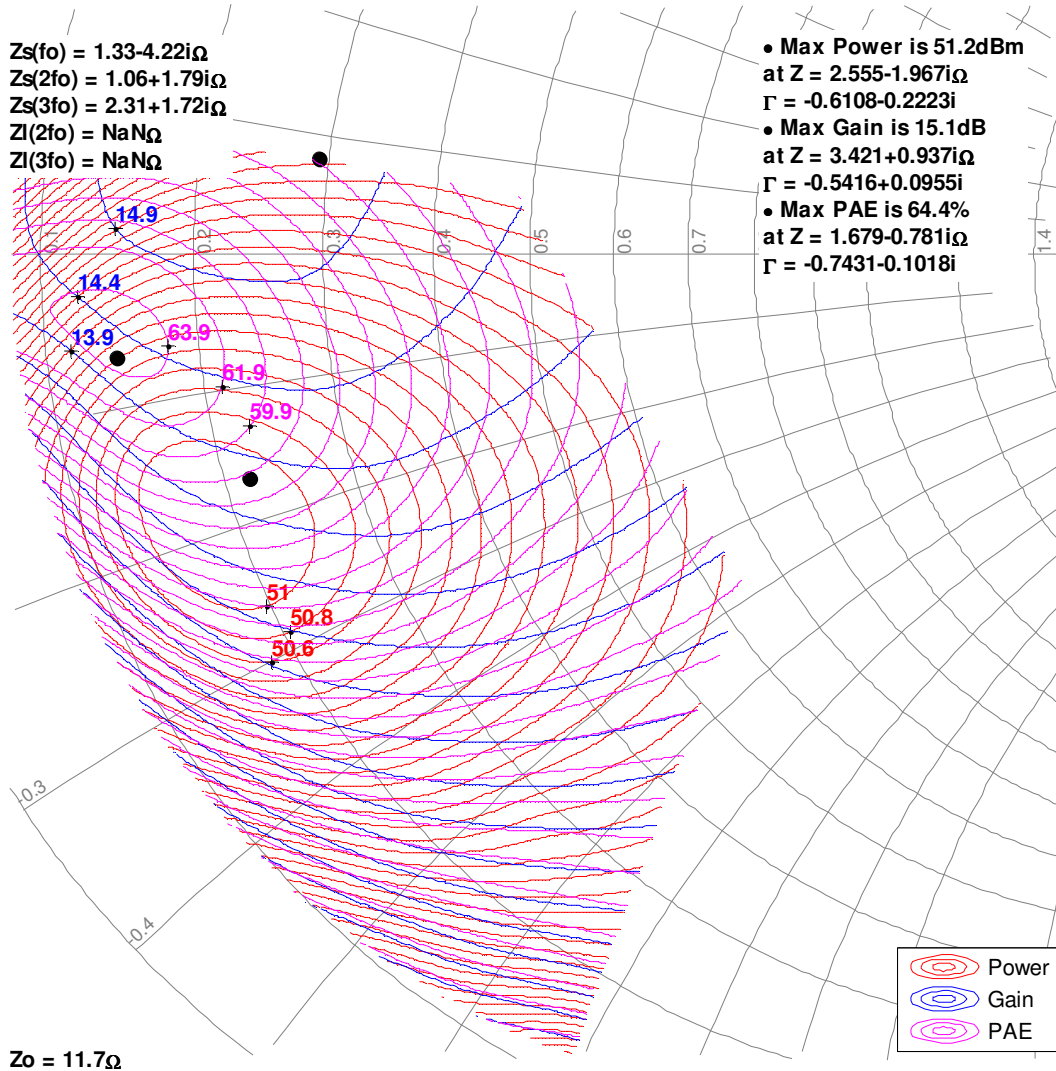

Load Pull Smith Charts (1, 2)

RF performance that the device typically exhibits when placed in the specified impedance environment. The impedances are not the impedances of the device, they are the impedances presented to the device via an RF circuit or load-pull system. The impedances listed follow an optimized trajectory to maintain high power and high efficiency at reference planes indicated on page 18.

Notes:

1. Test Conditions: $V_{DS} = 28\text{ V}$, $I_{DQ} = 260\text{ mA}$
2. Test Signal: Pulse Width = 100 μsec , Duty Cycle = 20%
3. NaN indicates the harmonic impedances are uncontrolled.

3GHz, Load-pull

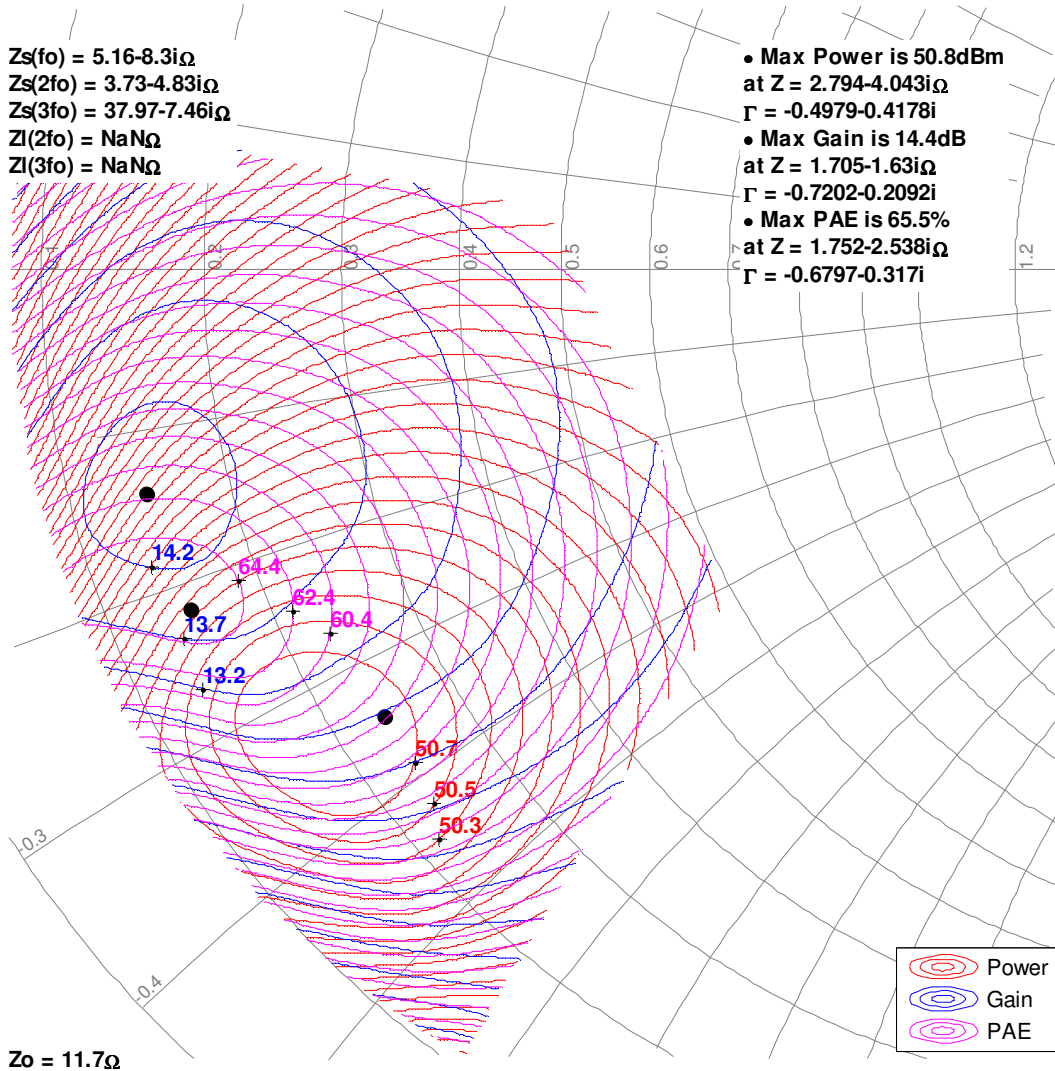

Load Pull Smith Charts (1, 2)

RF performance that the device typically exhibits when placed in the specified impedance environment. The impedances are not the impedances of the device, they are the impedances presented to the device via an RF circuit or load-pull system. The impedances listed follow an optimized trajectory to maintain high power and high efficiency at reference planes indicated on page 18.

Notes:

1. Test Conditions: $V_{DS} = 28\text{ V}$, $I_{DQ} = 260\text{ mA}$
2. Test Signal: Pulse Width = 100 μsec , Duty Cycle = 20%
3. NaN indicates the harmonic impedances are uncontrolled.

3.5GHz, Load-pull

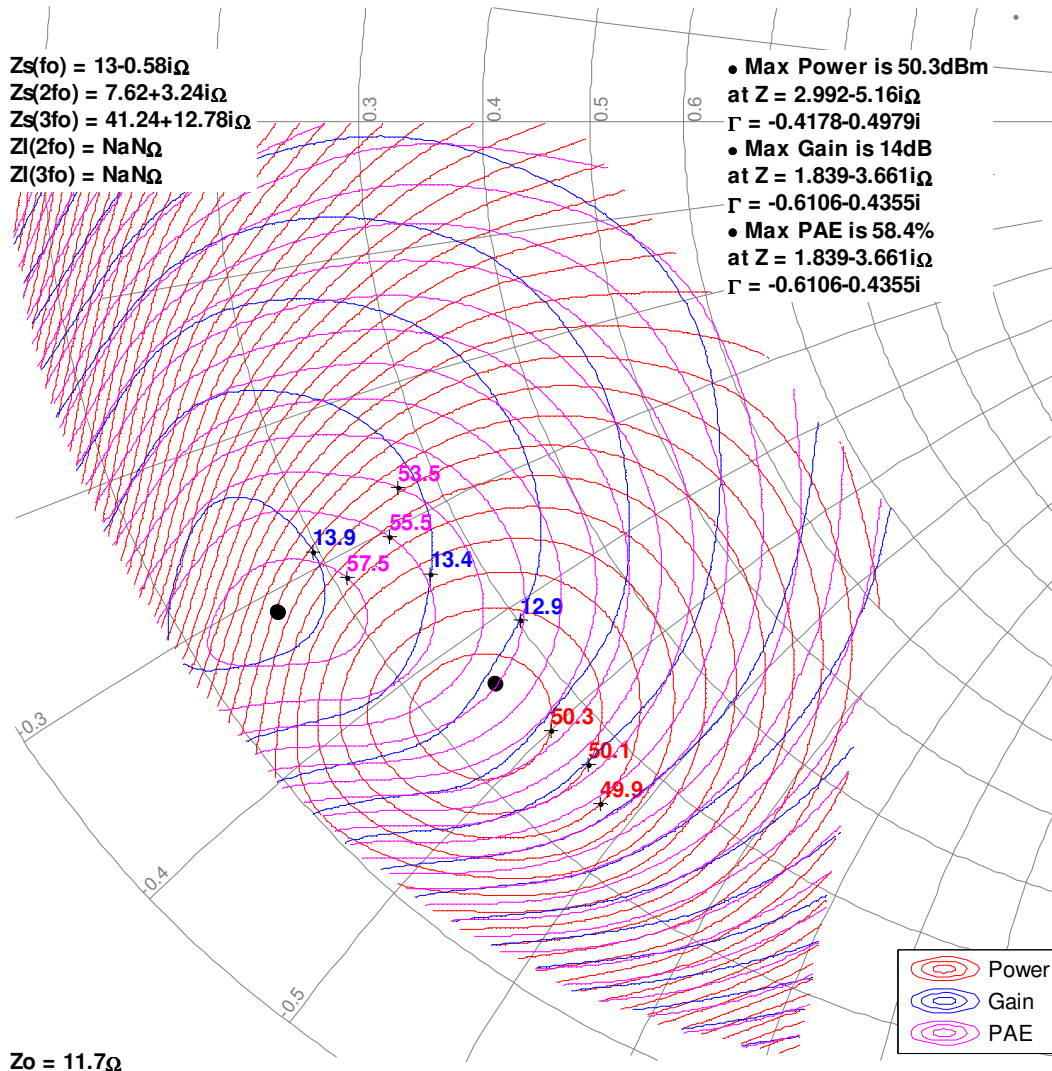

Typical Load-pull Performance – Power Tuned^(1, 2)

1. $V_{ds} = 28V$, $I_{dq} = 260mA$, Pulse Width = 100 μs , Duty Cycle = 20%, 25°C
2. Performance measured at device's reference planes. See page 18.

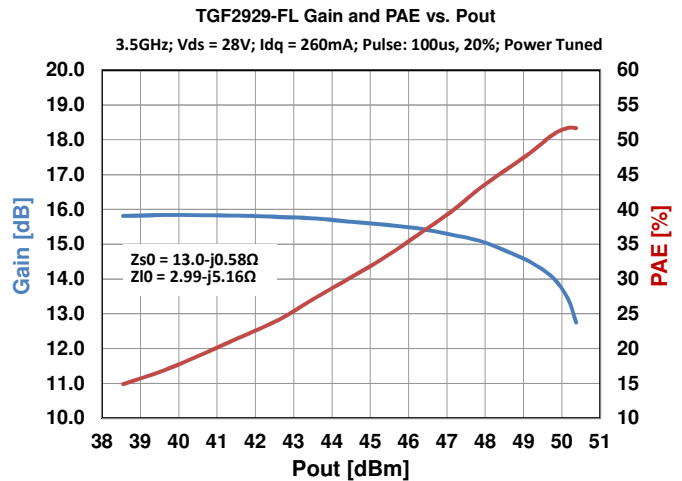
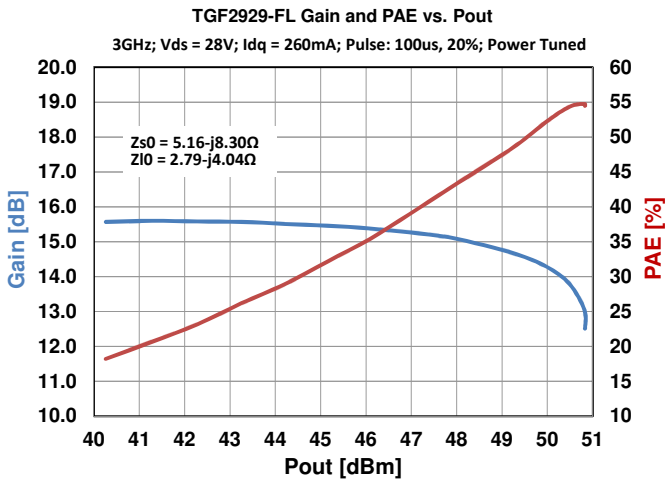
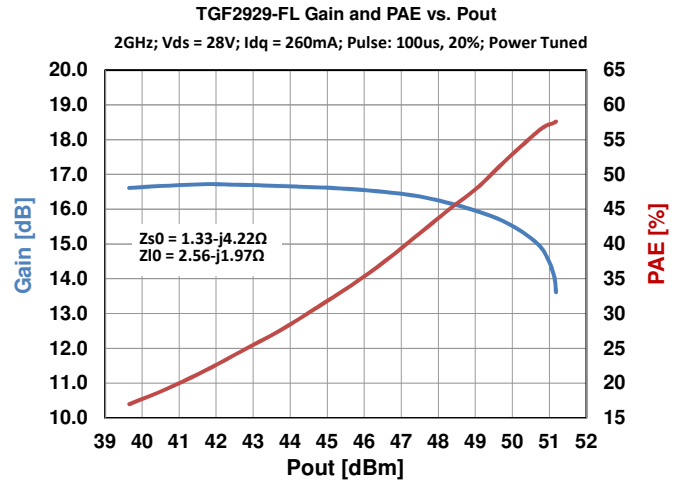
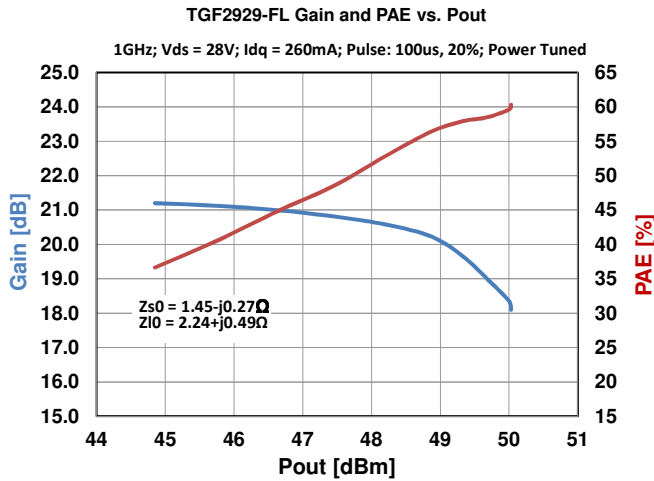

Typical Load-pull Performance – Efficiency Tuned^(1, 2)

1. $V_{ds} = 28V$, $I_{dq} = 260mA$, Pulse Width = 100 μ s, Duty Cycle = 20%, 25°C
2. Performance measured at device's reference planes. See page 18.

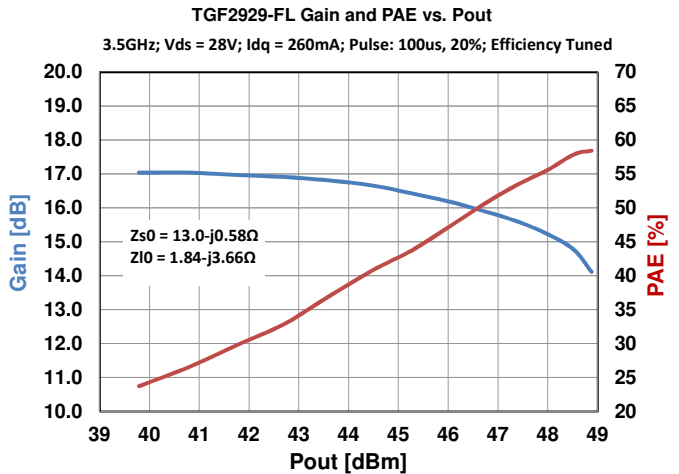
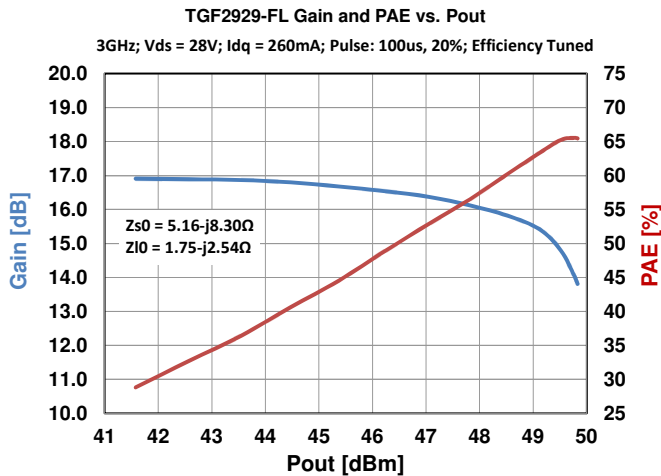
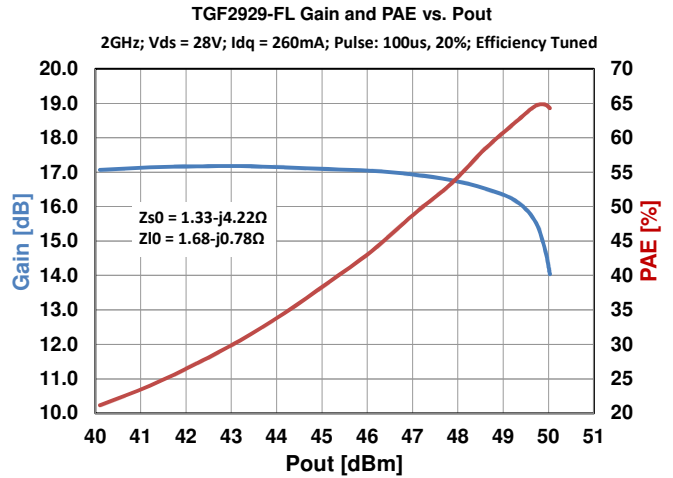
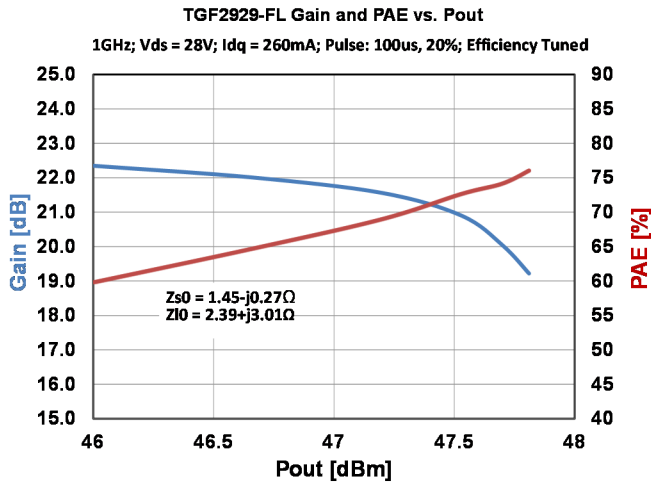

Performance Over Temperature (1, 2)

Performance measured in TriQuint's 3.1 GHz to 3.5 GHz Evaluation Board at 3 dB compression.

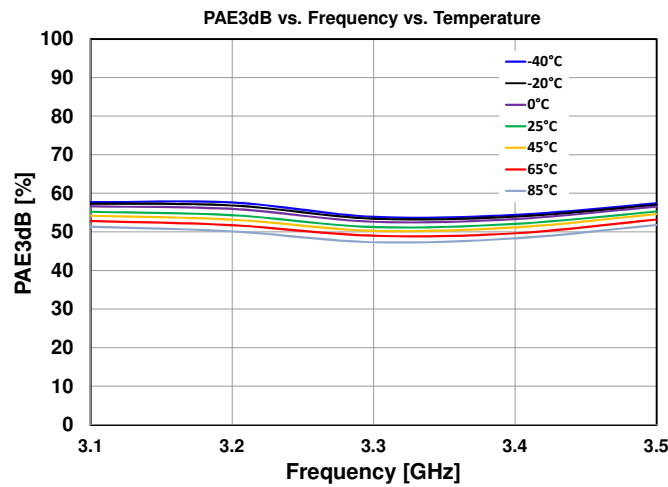
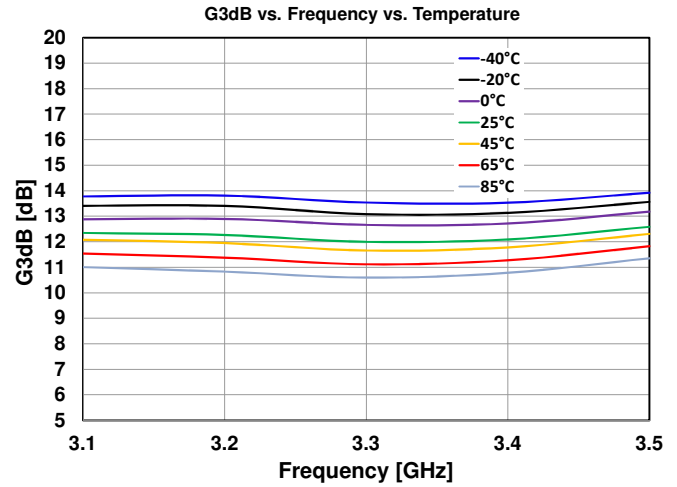
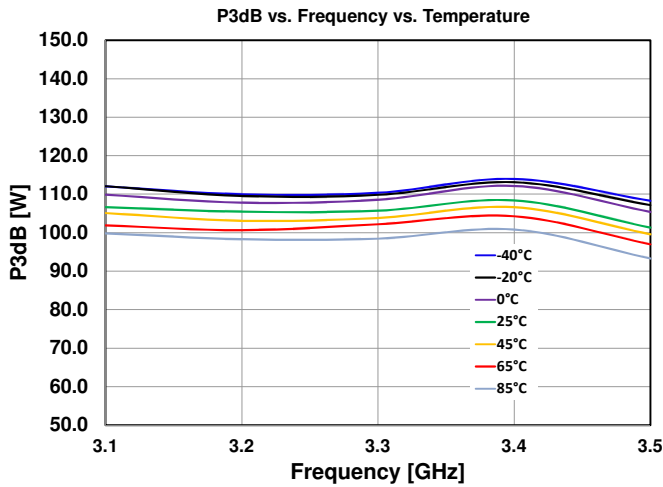

Notes:

1. Test Conditions: $V_{DS} = 28\text{ V}$, $I_{DQ} = 260\text{ mA}$
2. Test Signal: Pulse Width = 100 μs , Duty Cycle = 20%

Evaluation Board Performance at 25 °C (1, 2)

Performance measured in TriQuint’s 3.1 GHz to 3.5 GHz Evaluation Board at 3 dB compression.

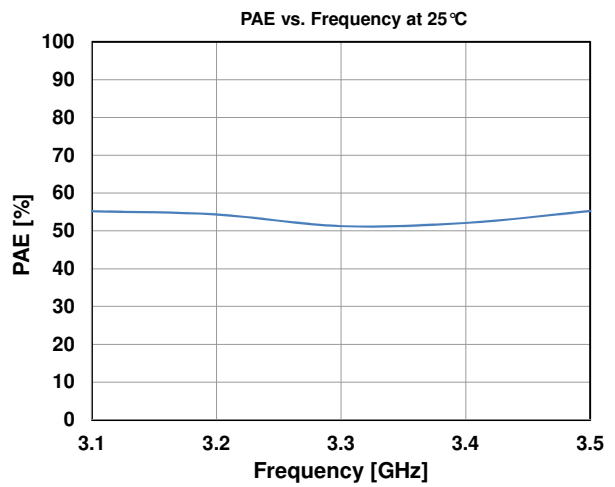
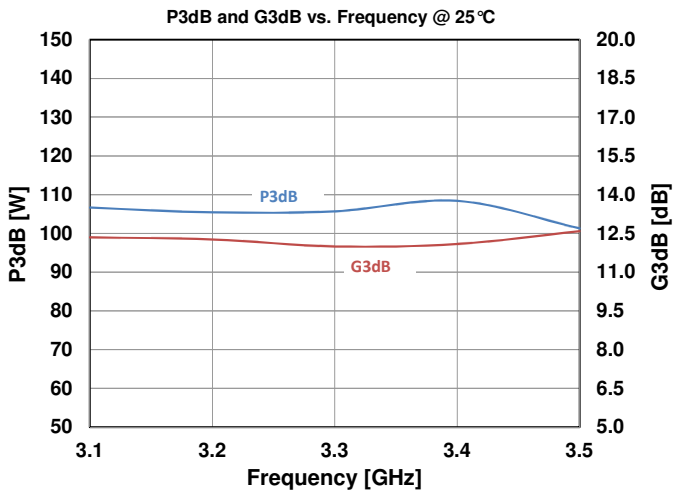

Notes:

1. Test Conditions: $V_{DS} = 28\text{ V}$, $I_{DQ} = 260\text{ mA}$
2. Test Signal: Pulse Width = 100 μs , Duty Cycle = 20 %

Application Circuit

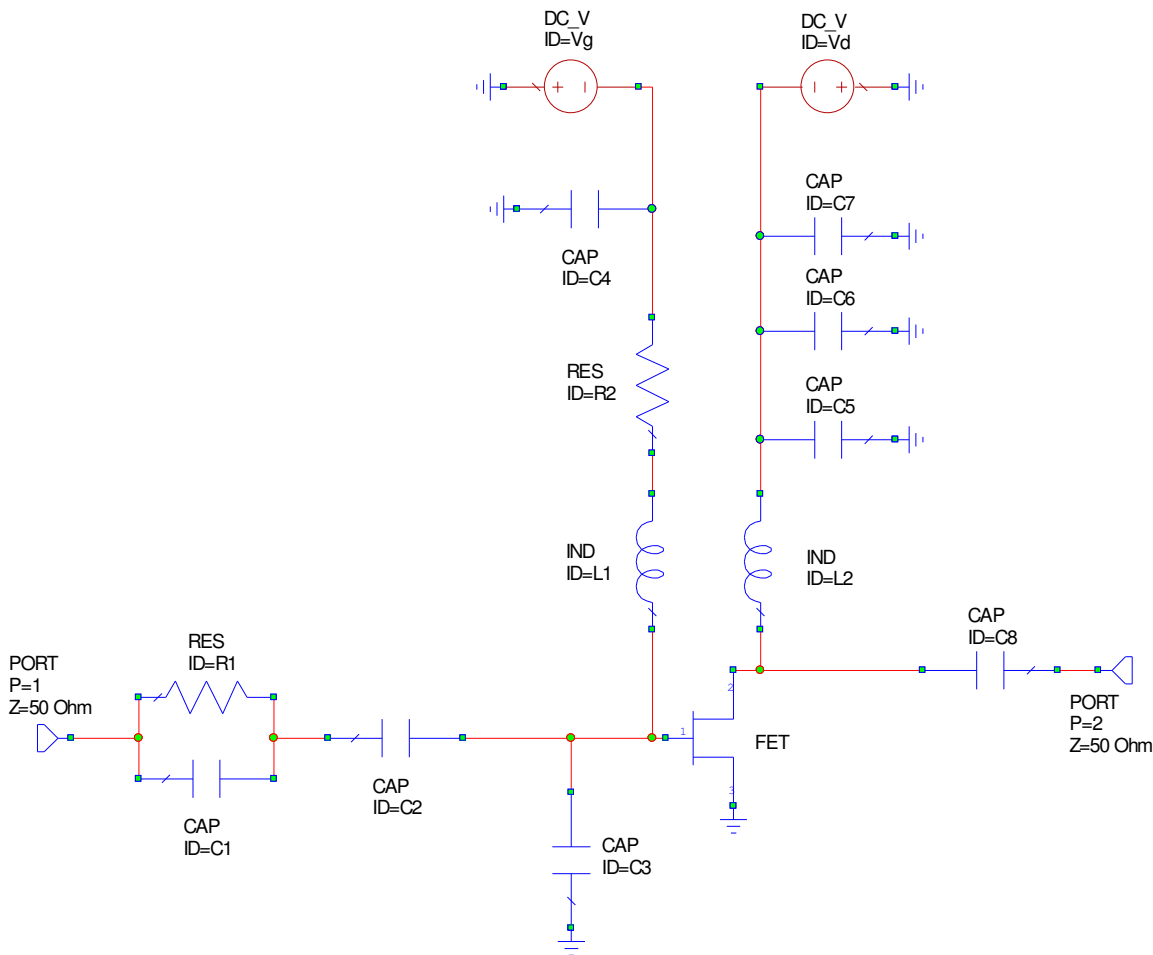

Bias-up Procedure

1. V_G set to -5 V.
2. V_D set to 28 V.
3. Adjust V_G more positive until quiescent I_D is 260 mA.
4. Apply RF signal.

Bias-down Procedure

1. Turn off RF signal.
2. Turn off V_D and wait 1 second to allow drain capacitor dissipation.
3. Turn off V_G .

Evaluation Board Layout

Top RF layer is 0.020" thick Rogers RO4350B, $\epsilon_r = 3.48$. The pad pattern shown has been developed and tested for optimized assembly at TriQuint Semiconductor. The PCB land pattern has been developed to accommodate lead and package tolerances.

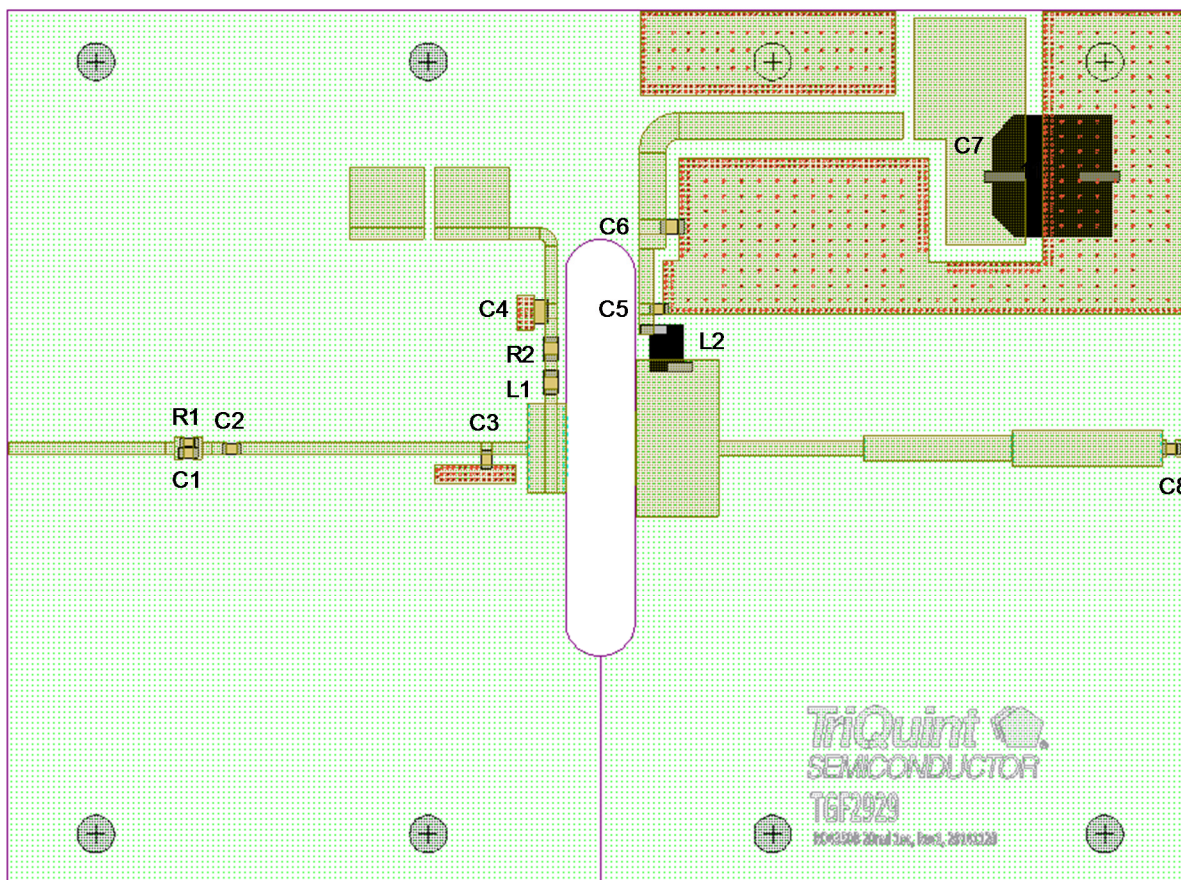

Bill of Materials

Reference Design	Value	Qty	Manufacturer	Part Number
R1	100 Ω	1	Vishay/Dale	CRCW0603100RJNEA
C1, C2	5.6 pF	2	ATC	600S5R6BT
C3	1.0 pF	1	ATC	600S1R0BT
L1	22 nH	1	Coilcraft	0805CS-220X-LB
R2	10 Ω	1	Vishay/Dale	CRCW060310R0JNEA
C4	10 μ F	1	Murata	C1632X5R0J106M130AC
L2	12 nH	1	Coilcraft	A04T_L
C5	2400 pF	1	Murata	C08BL242X-5UN-X0T
C6	1000 pF	1	ATC	800B102JT50XT
C7	220 μ F	1	United Chemi-Con	EMVY500ADA221MJA0G
C8	15 pF	1	ATC	600S150JT250XT

Pin Layout

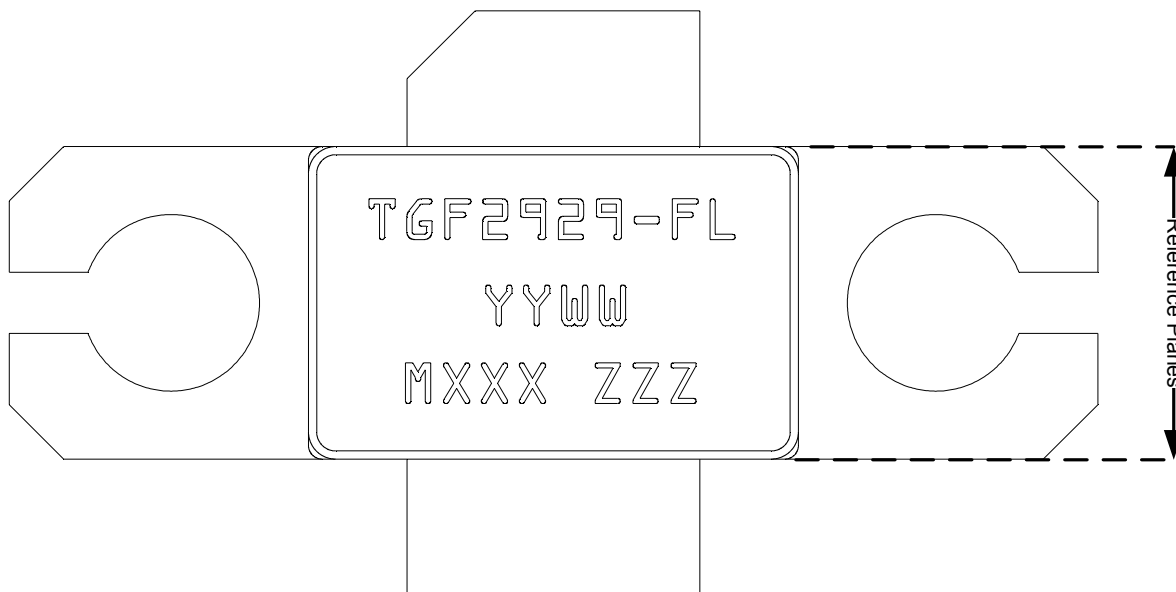

Note:

The TGF2929-FL will be marked with the "TGF2929-FL" designator and a lot code marked below the part designator. The "YY" represents the last two digits of the calendar year the part was manufactured, the "WW" is the work week of the assembly lot start, the "MXXX" is the production lot number, and the "ZZZ" is an auto-generated serial number.

Pin Description

Pin	Symbol	Description
1	V_D / RF OUT	Drain voltage / RF Output
2	V_G / RF IN	Gate voltage / RF
3	Flange	Source connected to ground

Mechanical Information

All dimensions are in inches.

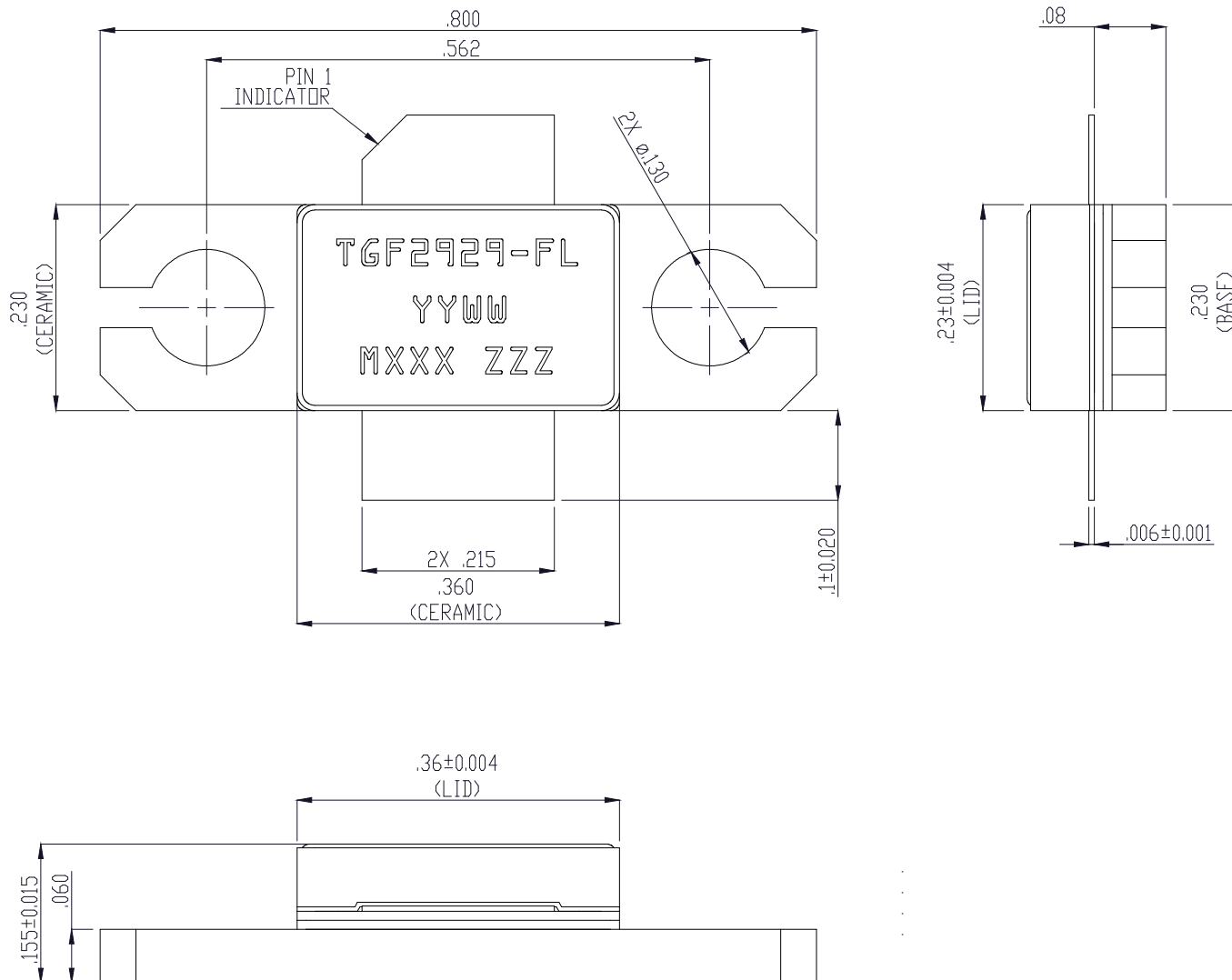

Note:

Unless otherwise noted, all tolerances are ± 0.005 inches. This package is lead-free/RoHS-compliant. The plating material on the leads is NiAu. It is compatible with both lead-free and tin-lead soldering processes.

Product Compliance Information

ESD Sensitivity Ratings



Caution! ESD-Sensitive Device

ESD Rating: Class 1B
 Value: ≥ 500 V and < 1000 V
 Test: Human Body Model (HBM)
 Standard: JEDEC Standard JESD22-A114

MSL Rating

The part is rated Moisture Sensitivity Level 3 at 260°C per JEDEC standard IPC/JEDEC J-STD-020.

ECCN

US Department of Commerce EAR99

Solderability

Compatible with the latest version of J-STD-020, Lead free solder, 260° C

RoHS Compliance

This part is compliant with EU 2002/95/EC RoHS directive (Restrictions on the Use of Certain Hazardous Substances in Electrical and Electronic Equipment).

This product also has the following attributes:

- Lead Free
- Halogen Free (Chlorine, Bromine)
- Antimony Free
- TBBP-A (C₁₅H₁₂Br₄O₂) Free
- PFOS Free
- SVHC Free

Recommended Soldering Temperature Profile

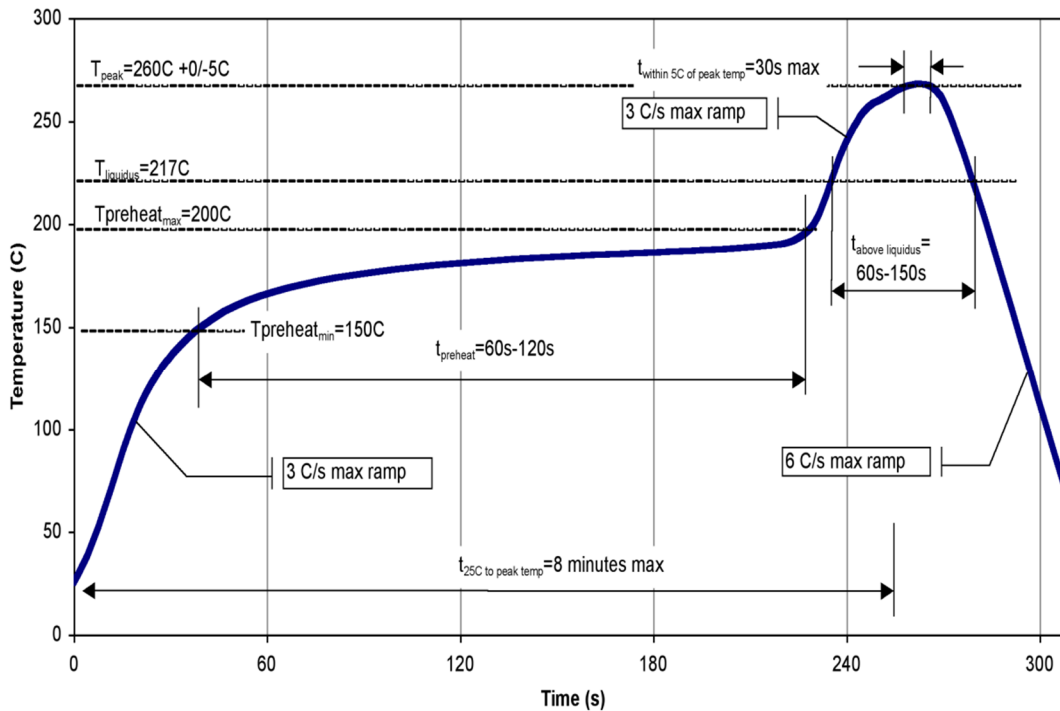

Contact Information

For the latest specifications, additional product information, worldwide sales and distribution locations, and information about TriQuint:

Web: www.triquint.com

Email: info-sales@triquint.com

Tel: +1.972.994.8465

Fax: +1.972.994.8504

For technical questions and application information:

Email: info-products@triquint.com

Important Notice

The information contained herein is believed to be reliable. TriQuint makes no warranties regarding the information contained herein. TriQuint assumes no responsibility or liability whatsoever for any of the information contained herein. TriQuint assumes no responsibility or liability whatsoever for the use of the information contained herein. The information contained herein is provided "AS IS, WHERE IS" and with all faults, and the entire risk associated with such information is entirely with the user. All information contained herein is subject to change without notice. Customers should obtain and verify the latest relevant information before placing orders for TriQuint products. The information contained herein or any use of such information does not grant, explicitly or implicitly, to any party any patent rights, licenses, or any other intellectual property rights, whether with regard to such information itself or anything described by such information.

TriQuint products are not warranted or authorized for use as critical components in medical, life-saving, or life-sustaining applications, or other applications where a failure would reasonably be expected to cause severe personal injury or death.