

## VOLTAGE REGULATOR WITH ON/OFF SWITCH

### FEATURES

- Low Dropout Voltage
- CMOS/TTL Compatible ON/OFF Switch
- Very Low Standby Current 180  $\mu$ A (ON, No Load)
- Internal Thermal Shutdown
- Short Circuit Protection
- Very Low (0.1  $\mu$ A) Current in OFF Mode
- Low Noise with External Bypass Capacitor

### DESCRIPTION

The TK112XX is a low power, linear regulator with a built-in electronic switch. The internal electronic switch can be controlled by TTL or CMOS logic levels. The device is in the ON state when the control pin is pulled to a high logic level. A pin for a bypass capacitor is provided, which connects to the internal circuitry, to lower the overall output noise level.

An internal PNP pass-transistor is used in order to achieve low dropout voltage (typically 100 mV at 30 mA load current). The device has very low quiescent current (180  $\mu$ A) in the ON mode with no load and 1 mA with 30 mA load. The quiescent current is typically 2.5 mA at 60 mA load. When the device is in standby mode ( $V_{CONT} = 0$ ), the quiescent current is typically 100 nA. An internal thermal shutdown circuit limits the junction temperature to below 150 °C. The load current is internally monitored and the device will shut down in the presence of a short circuit at the output.

### APPLICATIONS

- Battery Powered Systems
- Cellular Telephones
- Pagers
- Personal Communications Equipment
- Portable Instrumentation
- Portable Consumer Equipment
- Radio Control Systems
- Toys
- Low Voltage Systems

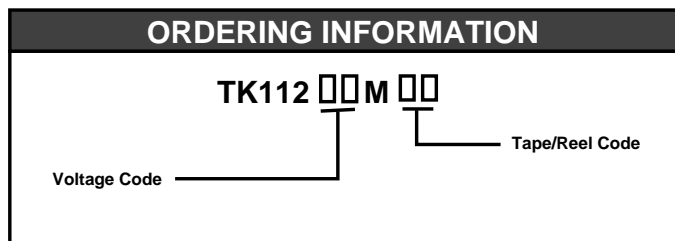

VOLTAGE CODE	
27 = 2.75 V	40 = 4.0 V
30 = 3.0 V	45 = 4.5 V
32 = 3.25 V	47 = 4.75 V
35 = 3.5 V	50 = 5.0 V

TAPE/REEL CODE
BX : Bulk/Bag
TL : Tape Left

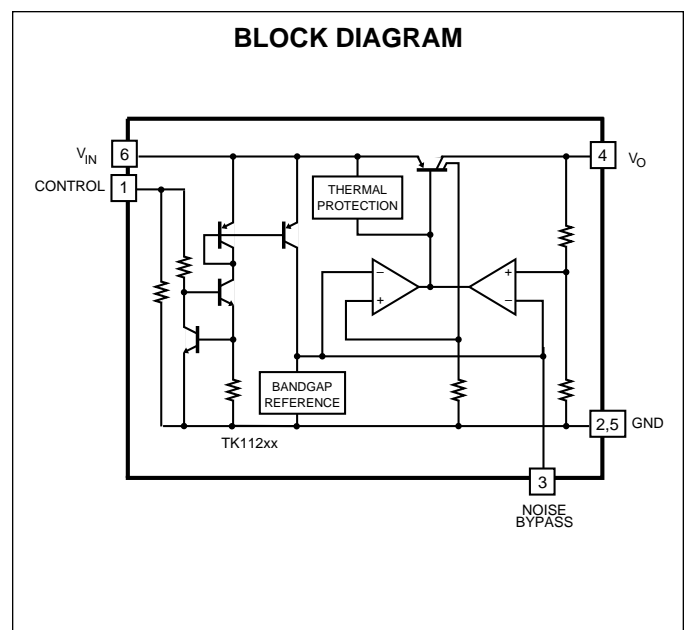
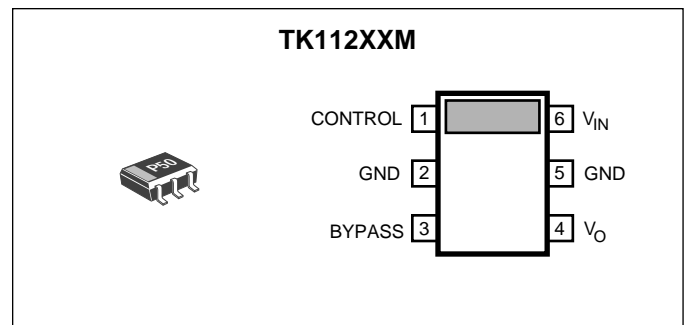

# TK112xx

## ABSOLUTE MAXIMUM RATINGS

Supply Voltage .....	16 V	Operating Temperature Range .....	-30 to +80 °C
Output Current .....	220 mA	Lead Soldering Temp. (10 sec.) .....	240 °C
Power Dissipation (Note 1) .....	400 mW	Junction Temperature .....	150 °C
Storage Temperature Range .....	-55 to +150 °C		

## TK11227 ELECTRICAL CHARACTERISTICS

Test conditions:  $T_A = 25\text{ °C}$ ,  $V_{IN} = 3.8\text{ V}$ , unless otherwise specified.

SYMBOL	PARAMETER	TEST CONDITIONS	MIN	TYP	MAX	UNITS
$V_{IN}$	Supply Voltage Range		1.8		15	V
$I_{IN}$	Supply Current	$I_O = 0\text{ mA}$ , Except $I_{CONT}$		170	350	$\mu\text{A}$
$I_{INS}$	Standby Current	$V_{IN} = 8\text{ V}$ , Output off			0.1	$\mu\text{A}$
$V_O$	Output Voltage	$I_O = 30\text{ mA}$	2.66	2.75	2.84	V
$V_{DROP}$	Dropout Voltage	$I_O = 60\text{ mA}$		0.18	0.3	V
$I_O$	Output Current	Note 3	150	170		mA
$I_{OR}$	Recommended Output Current				130	mA
Line Reg	Line Regulation	$V_{IN} = 3.25 \rightarrow 8.25\text{ V}$		3.0	20	mV
Load Reg	Load Regulation	$I_O = 5\text{ mA} \rightarrow 60\text{ mA}$		30	60	mV
		$I_O = 5\text{ mA} \rightarrow 100\text{ mA}$		80	150	mV
RR	Ripple Rejection	100 mV(rms), $f = 400\text{ Hz}$ , $I_O = 10\text{ mA}$		60		dB
$\Delta V_O / \Delta T_A$	Temperature Coefficient	$I_O = 10\text{ mA}$ $-25\text{ °C} \leq T_A \leq +75\text{ °C}$		0.15		mV/°C
$V_{NO}$	Output Noise Voltage	10 Hz < $f$ < 100 kHz, $I_O = 30\text{ mA}$ , $C_p = 0.01\text{ }\mu\text{F}$		30		$\mu\text{V(rms)}$
$V_{REF}$	Noise Bypass Terminal Voltage			1.25		V
<b>Control Terminal Specification</b>						
$I_{CONT}$	Control Current	Output on, $V_{CONT} = 2.4\text{ V}$		14	40	$\mu\text{A}$
$V_{CONT}$	Control Voltage	Output on	2.4			V
		Output off			0.6	V
$t_r$	Output Rise Time Off $\rightarrow$ On	$I_O = 30\text{ mA}$ , $V_{CONT} = 0 \rightarrow 2.4\text{ V}$		0.3		ms

Note 1: Power dissipation must be derated at rate of 1.6 mW/°C for operation above 25 °C . Maximum power dissipation = 400 mW (When mounted as recommended), and 200 mW in free air.

Note 2: Output side capacitor should have low ESR at low temperatures if used below 0 °C.

Note 3:  $I_O$  (Output Current) is the measured current when the output voltage drops 0.3 V with respect to  $V_O$  at  $I_O = 30\text{ mA}$ .

Note 4: This measurement (pulse measurement) is with a constant  $T_J$ . The output change due to temperature change is not included.

**TK11230 ELECTRICAL CHARACTERISTICS**Test conditions:  $T_A = 25\text{ }^\circ\text{C}$ ,  $V_{IN} = 4\text{ V}$ , unless otherwise specified.

SYMBOL	PARAMETER	TEST CONDITIONS	MIN	TYP	MAX	UNITS
$V_{IN}$	Supply Voltage Range		1.8		15	V
$I_{IN}$	Supply Current	$I_O = 0\text{ mA}$ , Except $I_{CONT}$		170	350	$\mu\text{A}$
$I_{INS}$	Standby Current	$V_{IN} = 8\text{ V}$ , Output off			0.1	$\mu\text{A}$
$V_O$	Output Voltage	$I_O = 30\text{ mA}$	2.90	3.00	3.10	V
$V_{DROP}$	Dropout Voltage	$I_O = 60\text{ mA}$		0.18	0.3	V
$I_O$	Output Current	Note 3	150	170		mA
$I_{OR}$	Recommended Output Current				130.0	mA
Line Reg	Line Regulation	$V_{IN} = 3.5 \rightarrow 8.5\text{ V}$		3.0	20	mV
Load Reg	Load Regulation	$I_O = 5\text{ mA} \rightarrow 60\text{ mA}$		30	60	mV
		$I_O = 5\text{ mA} \rightarrow 100\text{ mA}$		80	150	mV
RR	Ripple Rejection	100 mV(rms), $f = 400\text{ Hz}$ , $I_O = 10$		60.0		dB
$\Delta V_O/\Delta T_A$	Temperature Coefficient	$I_O = 10\text{ mA}$ $-25\text{ }^\circ\text{C} \leq T_A \leq +75\text{ }^\circ\text{C}$		0.15		mV/ $^\circ\text{C}$
$V_{NO}$	Output Noise Voltage	10 Hz < $f$ < 100 kHz, $I_O = 30\text{ mA}$ , $C_p = 0.01\text{ }\mu\text{F}$		30		$\mu\text{V}$ (rms)
$V_{REF}$	Noise Bypass Terminal Voltage			1.25		V
<b>Control Terminal Specification</b>						
$I_{CONT}$	Control Current	Output on, $V_{CONT} = 2.4\text{ V}$		14	40	$\mu\text{A}$
$V_{CONT}$	Control Voltage	Output on	2.4			V
		Output off			0.6	V
$t_r$	Output Rise Time Off $\rightarrow$ On	$I_O = 30\text{ mA}$ , $V_{CONT} = 0 \rightarrow 2.4\text{ V}$		0.3		ms

Note 1: Power dissipation must be derated at rate of 1.6 mW/ $^\circ\text{C}$  for operation above 25  $^\circ\text{C}$ . Maximum power dissipation = 400 mW (When mounted as recommended), and 200 mW in free air.

Note 2: Output side capacitor should have low ESR at low temperatures if used below 0  $^\circ\text{C}$ .

Note 3:  $I_O$  (Output Current) is the measured current when the output voltage drops 0.3 V with respect to  $V_O$  at  $I_O = 30\text{ mA}$ .

Note 4: This measurement (pulse measurement) is with a constant  $T_J$ . The output change due to temperature change is not included.

**TK11232 ELECTRICAL CHARACTERISTICS**Test conditions:  $T_A = 25\text{ }^\circ\text{C}$ ,  $V_{IN} = 4.3\text{ V}$ , unless otherwise specified.

SYMBOL	PARAMETER	TEST CONDITIONS	MIN	TYP	MAX	UNITS
$V_{IN}$	Supply Voltage Range		1.8		15	V
$I_{IN}$	Supply Current	$I_O = 0\text{ mA}$ , Except $I_{CONT}$		170	350	$\mu\text{A}$
$I_{INS}$	Standby Current	$V_{IN} = 8\text{ V}$ , Output off			0.1	$\mu\text{A}$
$V_O$	Output Voltage	$I_O = 30\text{ mA}$	3.15	3.25	3.35	V
$V_{DROP}$	Dropout Voltage	$I_O = 60\text{ mA}$		0.18	0.3	V
$I_O$	Output Current	Note 3	150	170		mA
$I_{OR}$	Recommended Output Current				130	mA
Line Reg	Line Regulation	$V_{IN} = 3.75 \rightarrow 8.75\text{ V}$		3.0	20	mV
Load Reg	Load Regulation	$I_O = 5\text{ mA} \rightarrow 60\text{ mA}$		30	60	mV
		$I_O = 5\text{ mA} \rightarrow 100\text{ mA}$		80	150	mV
RR	Ripple Rejection	100 mV(rms), $f = 400\text{ Hz}$ , $I_O = 10\text{ mA}$		60.0		dB
$\Delta V_O/\Delta T_A$	Temperature Coefficient	$I_O = 10\text{ mA}$ $-25\text{ }^\circ\text{C} \leq T_A \leq +75\text{ }^\circ\text{C}$		0.15		mV/ $^\circ\text{C}$
$V_{NO}$	Output Noise Voltage	10 Hz < $f$ < 100 kHz, $I_O = 30\text{ mA}$ , $C_p = 0.01\text{ }\mu\text{F}$		30		$\mu\text{V}(\text{rms})$
$V_{REF}$	Noise Bypass Terminal Voltage			1.25		V
<b>Control Terminal Specification</b>						
$I_{CONT}$	Control Current	Output on, $V_{CONT} = 2.4\text{ V}$		14	40	$\mu\text{A}$
$V_{CONT}$	Control Voltage	Output on	2.4			V
		Output off			0.6	V
$t_r$	Output Rise Time Off $\rightarrow$ On	$I_O = 30\text{ mA}$ , $V_{CONT} = 0 \rightarrow 2.4\text{ V}$		0.3		ms

Note 1: Power dissipation must be derated at rate of 1.6 mW/ $^\circ\text{C}$  for operation above 25  $^\circ\text{C}$ . Maximum power dissipation = 400 mW (When mounted as recommended), and 200 mW in free air.

Note 2: Output side capacitor should have low ESR at low temperatures if used below 0  $^\circ\text{C}$ .

Note 3:  $I_O$  (Output Current) is the measured current when the output voltage drops 0.3 V with respect to  $V_O$  at  $I_O = 30\text{ mA}$ .

Note 4: This measurement (pulse measurement) is with a constant  $T_J$ . The output change due to temperature change is not included.

**TK11235 ELECTRICAL CHARACTERISTICS**Test conditions:  $T_A = 25\text{ }^\circ\text{C}$ ,  $V_{IN} = 4.5\text{ V}$ , unless otherwise specified.

SYMBOL	PARAMETER	TEST CONDITIONS	MIN	TYP	MAX	UNITS
$V_{IN}$	Supply Voltage Range		1.8		15	V
$I_{IN}$	Supply Current	$I_O = 0\text{ mA}$ , Except $I_{CONT}$		170	350	$\mu\text{A}$
$I_{INS}$	Standby Current	$V_{IN} = 8\text{ V}$ , Output off			0.1	$\mu\text{A}$
$V_O$	Output Voltage	$I_O = 30\text{ mA}$	3.39	3.5	3.61	V
$V_{DROPO}$	Dropout Voltage	$I_O = 60\text{ mA}$		0.18	0.3	V
$I_O$	Output Current	Note 3	150	170		mA
$I_{OR}$	Recommended Output Current				130	mA
Line Reg	Line Regulation	$V_{IN} = 4 \rightarrow 9\text{ V}$		3.0	20	mV
Load Reg	Load Regulation	$I_O = 5\text{ mA} \rightarrow 60\text{ mA}$		30	60	mV
		$I_O = 5\text{ mA} \rightarrow 100\text{ mA}$		80	150	mV
RR	Ripple Rejection	100 mV(rms), $f = 400\text{ Hz}$ , $I_O = 10\text{ mA}$		60.0		dB
$\Delta V_O/\Delta T_A$	Temperature Coefficient	$I_O = 10\text{ mA}$ $-25\text{ }^\circ\text{C} \leq T_A \leq +75\text{ }^\circ\text{C}$		0.15		mV/ $^\circ\text{C}$
$V_{NO}$	Output Noise Voltage	10 Hz < $f$ < 100 kHz, $I_O = 30\text{ mA}$ , $C_p = 0.01\text{ }\mu\text{F}$		35		$\mu\text{V(rms)}$
$V_{REF}$	Noise Bypass Terminal Voltage			1.25		V
<b>Control Terminal Specification</b>						
$I_{CONT}$	Control Current	Output on, $V_{CONT} = 2.4\text{ V}$		14	40	$\mu\text{A}$
$V_{CONT}$	Control Voltage	Output on	2.4			V
		Output off			0.6	V
$t_r$	Output Rise Time Off $\rightarrow$ On	$I_O = 30\text{ mA}$ , $V_{CONT} = 0 \rightarrow 2.4\text{ V}$		0.3		ms

Note 1: Power dissipation must be derated at rate of 1.6 mW/ $^\circ\text{C}$  for operation above 25  $^\circ\text{C}$ . Maximum power dissipation = 400 mW (When mounted as recommended), and 200 mW in free air.

Note 2: Output side capacitor should have low ESR at low temperatures if used below 0  $^\circ\text{C}$ .

Note 3:  $I_O$  (Output Current) is the measured current when the output voltage drops 0.3 V with respect to  $V_O$  at  $I_O = 30\text{ mA}$ .

Note 4: This measurement (pulse measurement) is with a constant  $T_J$ . The output change due to temperature change is not included.

# TK112xx

## TK11240 ELECTRICAL CHARACTERISTICS

Test conditions:  $T_A = 25\text{ }^\circ\text{C}$ ,  $V_{IN} = 5\text{ V}$ , unless otherwise specified.

SYMBOL	PARAMETER	TEST CONDITIONS	MIN	TYP	MAX	UNITS
$V_{IN}$	Supply Voltage Range		1.8		15	V
$I_{IN}$	Supply Current	$I_O = 0\text{ mA}$ , Except $I_{CONT}$		170	350	$\mu\text{A}$
$I_{INS}$	Standby Current	$V_{IN} = 8\text{ V}$ , Output off			0.1	$\mu\text{A}$
$V_O$	Output Voltage	$I_O = 30\text{ mA}$	3.88	4.0	4.12	V
$V_{DROP}$	Dropout Voltage	$I_O = 60\text{ mA}$		0.18	0.3	V
$I_O$	Output Current	Note 3	150	170		mA
$I_{OR}$	Recommended Output Current				130	mA
Line Reg	Line Regulation	$V_{IN} = 4.5 \rightarrow 9.5\text{ V}$		3.0	20	mV
Load Reg	Load Regulation	$I_O = 5\text{ mA} \rightarrow 60\text{ mA}$		30	60	mV
		$I_O = 5\text{ mA} \rightarrow 100\text{ mA}$		80	150	mV
RR	Ripple Rejection	100 mV(rms), $f = 400\text{ Hz}$ , $I_O = 10\text{ mA}$		60		dB
$\Delta V_O / \Delta T_A$	Temperature Coefficient	$I_O = 10\text{ mA}$ $-25\text{ }^\circ\text{C} \leq T_A \leq +75\text{ }^\circ\text{C}$		0.2		mV/ $^\circ\text{C}$
$V_{NO}$	Output Noise Voltage	10 Hz < $f$ < 100 kHz, $I_O = 30\text{ mA}$ , $C_p = 0.01\text{ }\mu\text{F}$		40		$\mu\text{V}$ (rms)
$V_{REF}$	Noise Bypass Terminal Voltage			1.25		V
<b>Control Terminal Specification</b>						
$I_{CONT}$	Control Current	Output on, $V_{CONT} = 2.4\text{ V}$		14	40	$\mu\text{A}$
$V_{CONT}$	Control Voltage	Output on	2.4			V
		Output off			0.6	V
$t_r$	Output Rise Time Off $\rightarrow$ On	$I_O = 30\text{ mA}$ , $V_{CONT} = 0 \rightarrow 2.4\text{ V}$		0.3		ms

Note 1: Power dissipation must be derated at rate of 1.6 mW/ $^\circ\text{C}$  for operation above 25  $^\circ\text{C}$ . Maximum power dissipation = 400 mW (When mounted as recommended), and 200 mW in free air.

Note 2: Output side capacitor should have low ESR at low temperatures if used below 0  $^\circ\text{C}$ .

Note 3:  $I_O$  (Output Current) is the measured current when the output voltage drops 0.3 V with respect to  $V_O$  at  $I_O = 30\text{ mA}$ .

Note 4: This measurement (pulse measurement) is with a constant  $T_J$ . The output change due to temperature change is not included.

**TK11245 ELECTRICAL CHARACTERISTICS**Test conditions:  $T_A = 25\text{ }^\circ\text{C}$ ,  $V_{IN} = 5.5\text{ V}$ , unless otherwise specified.

SYMBOL	PARAMETER	TEST CONDITIONS	MIN	TYP	MAX	UNITS
$V_{IN}$	Supply Voltage Range		1.8		15	V
$I_{IN}$	Supply Current	$I_O = 0\text{ mA}$ , Except $I_{CONT}$		170	350	$\mu\text{A}$
$I_{INS}$	Standby Current	$V_{IN} = 8\text{ V}$ , Output off			0.1	$\mu\text{A}$
$V_O$	Output Voltage	$I_O = 30\text{ mA}$	4.37	4.5	4.63	V
$V_{DROP}$	Dropout Voltage	$I_O = 60\text{ mA}$		0.18	0.3	V
$I_O$	Output Current	Note 3	150	170		mA
$I_{OR}$	Recommended Output Current				130	mA
Line Reg	Line Regulation	$V_{IN} = 5 \rightarrow 10\text{ V}$		3.0	20	mV
Load Reg	Load Regulation	$I_O = 5\text{ mA} \rightarrow 60\text{ mA}$		30	60	mV
		$I_O = 5\text{ mA} \rightarrow 100\text{ mA}$		80	150	mV
RR	Ripple Rejection	100 mV(rms), $f = 400\text{ Hz}$ , $I_O = 10\text{ mA}$		60		dB
$\Delta V_O/\Delta T_A$	Temperature Coefficient	$I_O = 10\text{ mA}$ $-25\text{ }^\circ\text{C} \leq T_A \leq +75\text{ }^\circ\text{C}$		0.25		mV/ $^\circ\text{C}$
$V_{NO}$	Output Noise Voltage	10 Hz < $f$ < 100 kHz, $I_O = 30\text{ mA}$ , $C_p = 0.01\text{ }\mu\text{F}$		45		$\mu\text{V}$ (rms)
$V_{REF}$	Noise Bypass Terminal Voltage			1.25		V
<b>Control Terminal Specification</b>						
$I_{CONT}$	Control Current	Output on, $V_{CONT} = 2.4\text{ V}$		14	40	$\mu\text{A}$
$V_{CONT}$	Control Voltage	Output on	2.4			V
		Output off			0.6	V
$t_r$	Output Rise Time Off $\rightarrow$ On	$I_O = 30\text{ mA}$ , $V_{CONT} = 0 \rightarrow 2.4\text{ V}$		0.3		ms

Note 1: Power dissipation must be derated at rate of 1.6 mW/ $^\circ\text{C}$  for operation above 25  $^\circ\text{C}$ . Maximum power dissipation = 400 mW (When mounted as recommended), and 200 mW in free air.

Note 2: Output side capacitor should have low ESR at low temperatures if used below 0  $^\circ\text{C}$ .

Note 3:  $I_O$  (Output Current) is the measured current when the output voltage drops 0.3 V with respect to  $V_O$  at  $I_O = 30\text{ mA}$ .

Note 4: This measurement (pulse measurement) is with a constant  $T_J$ . The output change due to temperature change is not included.

**TK11247 ELECTRICAL CHARACTERISTICS**Test conditions:  $T_A = 25\text{ }^\circ\text{C}$ ,  $V_{IN} = 5.7\text{ V}$ , unless otherwise specified.

SYMBOL	PARAMETER	TEST CONDITIONS	MIN	TYP	MAX	UNITS
$V_{IN}$	Supply Voltage Range		1.8		15	V
$I_{IN}$	Supply Current	$I_O = 0\text{ mA}$ , Except $I_{CONT}$		170	350	$\mu\text{A}$
$I_{INS}$	Standby Current	$V_{IN} = 8\text{ V}$ , Output off			0.1	$\mu\text{A}$
$V_O$	Output Voltage	$I_O = 30\text{ mA}$	4.61	4.75	4.89	V
$V_{DROP}$	Dropout Voltage	$I_O = 60\text{ mA}$		0.18	0.3	V
$I_O$	Output Current	Note 3	150	170		mA
$I_{OR}$	Recommended Output Current				130	mA
Line Reg	Line Regulation	$V_{IN} = 5.25 \rightarrow 10.25\text{ V}$		3.0	20	mV
Load Reg	Load Regulation	$I_O = 5\text{ mA} \rightarrow 60\text{ mA}$		30	60	mV
		$I_O = 5\text{ mA} \rightarrow 100\text{ mA}$		80	150	mV
RR	Ripple Rejection	100 mV(rms), $f = 400\text{ Hz}$ , $I_O = 10\text{ mA}$		60		dB
$\Delta V_O/\Delta T_A$	Temperature Coefficient	$I_O = 10\text{ mA}$ $-25\text{ }^\circ\text{C} \leq T_A \leq +75\text{ }^\circ\text{C}$		0.4		mV/ $^\circ\text{C}$
$V_{NO}$	Output Noise Voltage	10 Hz < $f$ < 100 kHz, $I_O = 30\text{ mA}$ , $C_p = 0.01\text{ }\mu\text{F}$		45		$\mu\text{V}$ (rms)
$V_{REF}$	Noise Bypass Terminal Voltage			1.25		V
<b>Control Terminal Specification</b>						
$I_{CONT}$	Control Current	Output on, $V_{CONT} = 2.4\text{ V}$		14	40	$\mu\text{A}$
$V_{CONT}$	Control Voltage	Output on	2.4			V
		Output off			0.6	V
$t_r$	Output Rise Time Off $\rightarrow$ On	$I_O = 30\text{ mA}$ , $V_{CONT} = 0 \rightarrow 2.4\text{ V}$		0.3		ms

Note 1: Power dissipation must be derated at rate of 1.6 mW/ $^\circ\text{C}$  for operation above 25  $^\circ\text{C}$ . Maximum power dissipation = 400 mW (When mounted as recommended), and 200 mW in free air.

Note 2: Output side capacitor should have low ESR at low temperatures if used below 0  $^\circ\text{C}$ .

Note 3:  $I_O$  (Output Current) is the measured current when the output voltage drops 0.3 V with respect to  $V_O$  at  $I_O = 30\text{ mA}$ .

Note 4: This measurement (pulse measurement) is with a constant  $T_J$ . The output change due to temperature change is not included.



**TK11250 ELECTRICAL CHARACTERISTICS**Test conditions:  $T_A = 25\text{ }^\circ\text{C}$ ,  $V_{IN} = 6\text{ V}$ , unless otherwise specified.

SYMBOL	PARAMETER	TEST CONDITIONS	MIN	TYP	MAX	UNITS
$V_{IN}$	Supply Voltage Range		1.8		15	V
$I_{IN}$	Supply Current	$I_O = 0\text{ mA}$ , Except $I_{CONT}$		160	350	$\mu\text{A}$
$I_{INS}$	Standby Current	$V_{IN} = 8\text{ V}$ , Output off			0.1	$\mu\text{A}$
$V_O$	Output Voltage	$I_O = 30\text{ mA}$	4.85	5.0	515	V
$V_{DROD}$	Dropout Voltage	$I_O = 60\text{ mA}$		0.18	0.3	V
$I_O$	Output Current	Note 3	150	170		mA
$I_{OR}$	Recommended Output Current				130	mA
Line Reg	Line Regulation	$V_{IN} = 5.5 \rightarrow 10.5\text{ V}$		3.0	20	mV
Load Reg	Load Regulation	$I_O = 5\text{ mA} \rightarrow 60\text{ mA}$		30	60	mV
		$I_O = 5\text{ mA} \rightarrow 100\text{ mA}$		80	150	mV
RR	Ripple Rejection	100 mV(rms), $f = 400\text{ Hz}$ , $I_O = 10\text{ mA}$		60		dB
$\Delta V_O/\Delta T_A$	Temperature Coefficient	$I_O = 10\text{ mA}$ $-25\text{ }^\circ\text{C} \leq T_A \leq +75\text{ }^\circ\text{C}$		0.4		mV/ $^\circ\text{C}$
$V_{NO}$	Output Noise Voltage	10 Hz < $f$ < 100 kHz, $I_O = 30\text{ mA}$ , $C_p = 0.01\text{ }\mu\text{F}$		50		$\mu\text{V}$ (rms)
$V_{REF}$	Noise Bypass Terminal Voltage			1.25		V
<b>Control Terminal Specification</b>						
$I_{CONT}$	Control Current	Output on, $V_{CONT} = 2.4\text{ V}$		14	40	$\mu\text{A}$
$V_{CONT}$	Control Voltage	Output on	2.4			V
		Output off			0.6	V
$t_r$	Output Rise Time Off $\rightarrow$ On	$I_O = 30\text{ mA}$ , $V_{CONT} = 0 \rightarrow 2.4\text{ V}$		0.3		ms

Note 1: Power dissipation must be derated at rate of 1.6 mW/ $^\circ\text{C}$  for operation above 25  $^\circ\text{C}$ . Maximum power dissipation = 400 mW (When mounted as recommended), and 200 mW in free air.

Note 2: Output side capacitor should have low ESR at low temperatures if used below 0  $^\circ\text{C}$ .

Note 3:  $I_O$  (Output Current) is the measured current when the output voltage drops 0.3 V with respect to  $V_O$  at  $I_O = 30\text{ mA}$ .

Note 4: This measurement (pulse measurement) is with a constant  $T_J$ . The output change due to temperature change is not included.

## TEST CIRCUIT

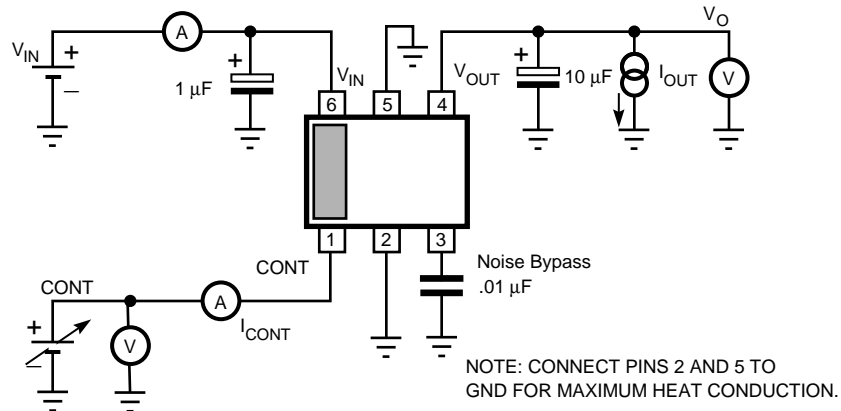

## TYPICAL PERFORMANCE CHARACTERISTICS

$T_A = 25^\circ\text{C}$  unless otherwise specified.

**DROPOUT VOLTAGE vs. LOAD CURRENT**

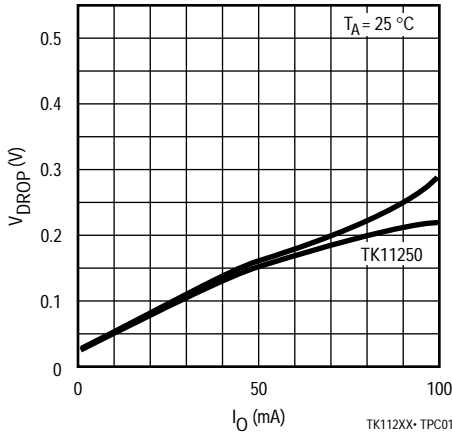

**OUTPUT VOLTAGE vs. SHORT CIRCUIT CURRENT**

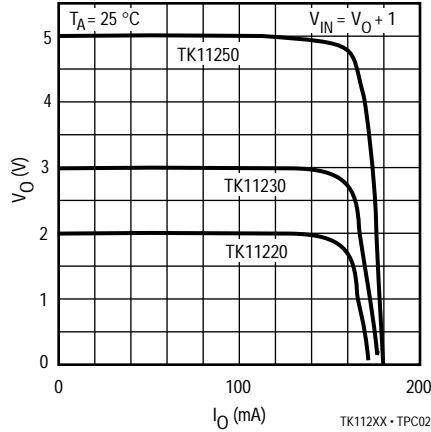

**CONTROL TERMINAL CIRCUIT CURRENT vs. CONTROL TERMINAL VOLTAGE**

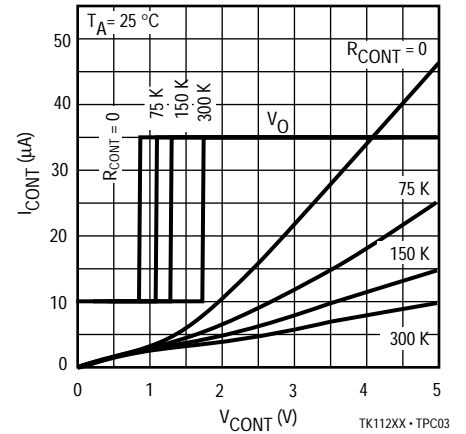

**QUIESCENT CURRENT vs. INPUT VOLTAGE**

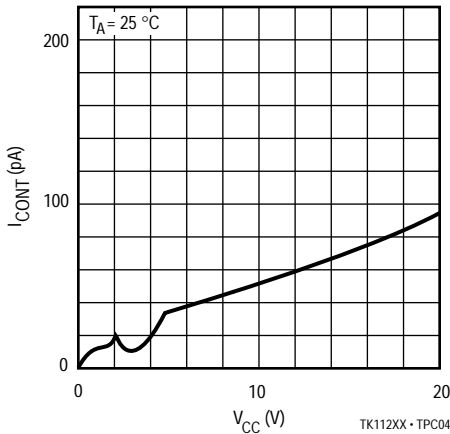

**RIPPLE REJECTION**

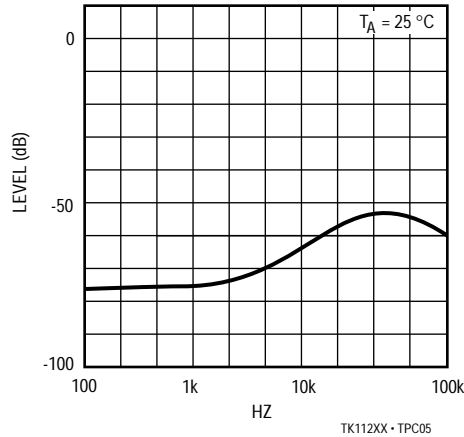

**LINE TRANSIENT RESPONSE**

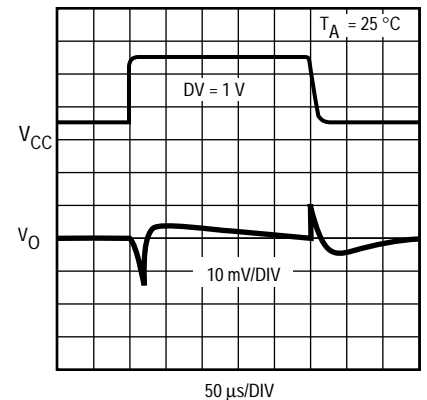

## TYPICAL PERFORMANCE CHARACTERISTICS (CONT.)

$T_A = 25^\circ\text{C}$  unless otherwise specified.

### LOAD TRANSIENT RESPONSE

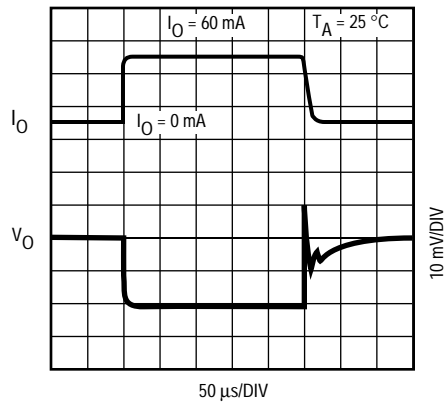

TK112XX · TPC07

### SHUTDOWN CONTROL (OFF-ON)

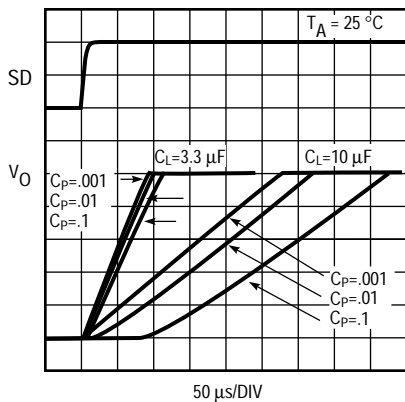

TK112XX · TPC08

### NOISE LEVEL vs. BYPASS CAPACITOR (pF)

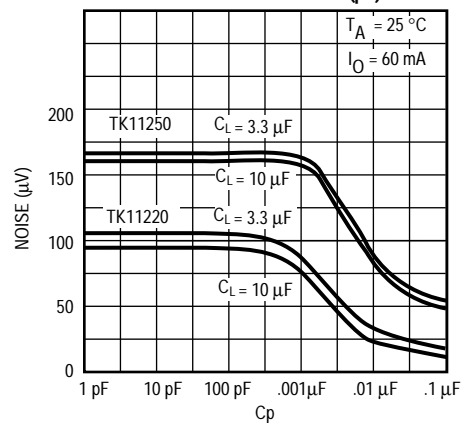

TK112XX · TPC09

### QUIESCENT CURRENT vs. TEMPERATURE

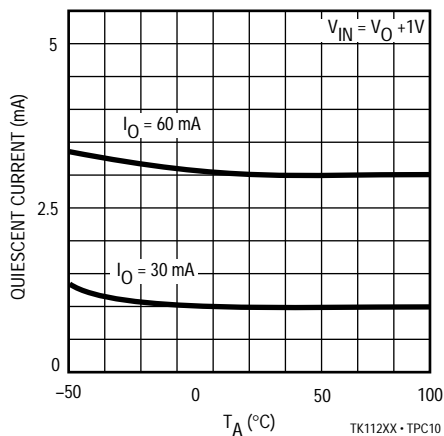

TK112XX · TPC10

### DROPOUT VOLTAGE vs. TEMPERATURE

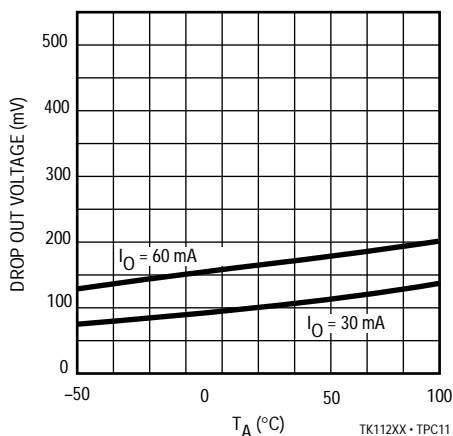

TK112XX · TPC11

### CONTROL PIN CURRENT vs. TEMPERATURE

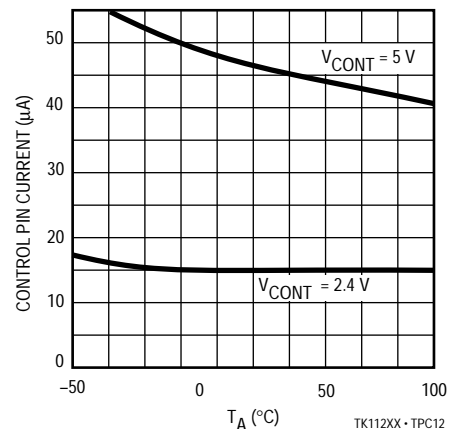

TK112XX · TPC12

### CONTROL PIN VOLTAGE vs. TEMPERATURE

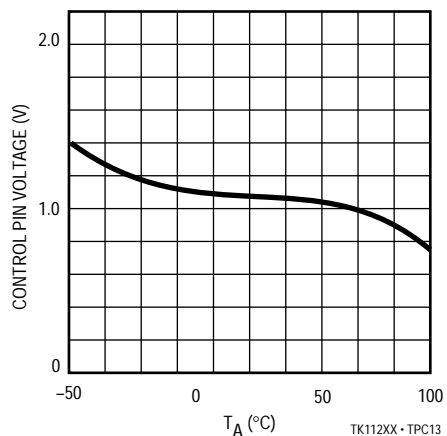

TK112XX · TPC13

### OUTPUT CURRENT vs. TEMPERATURE

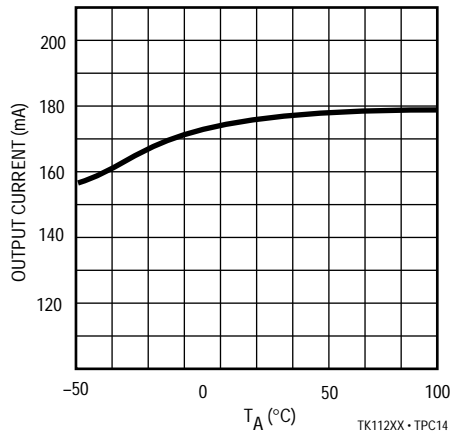

TK112XX · TPC14

## TYPICAL PERFORMANCE CHARACTERISTICS (CONT.)

$T_A = 25^\circ\text{C}$  unless otherwise specified.

### TK11227

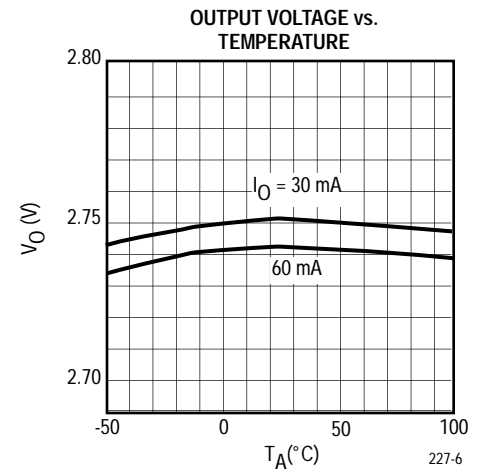
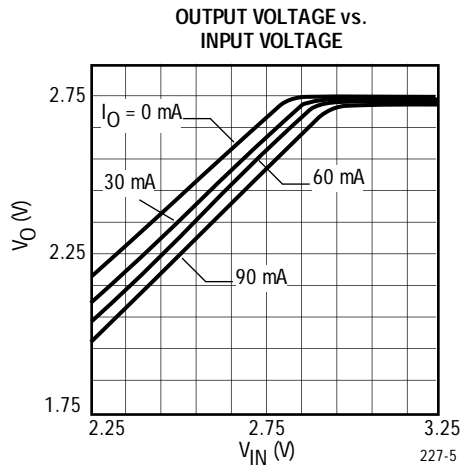
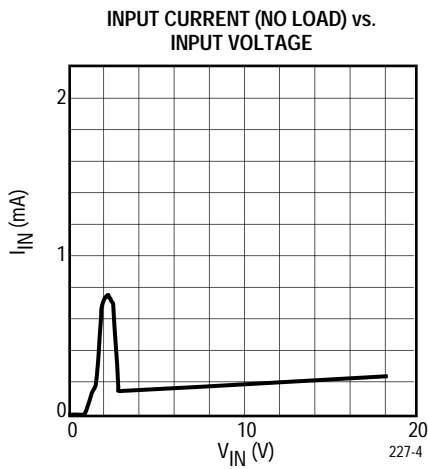
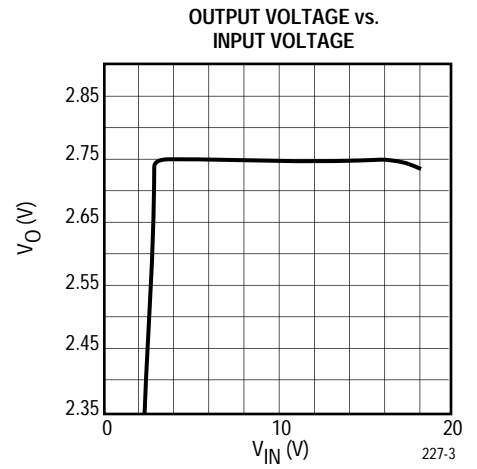
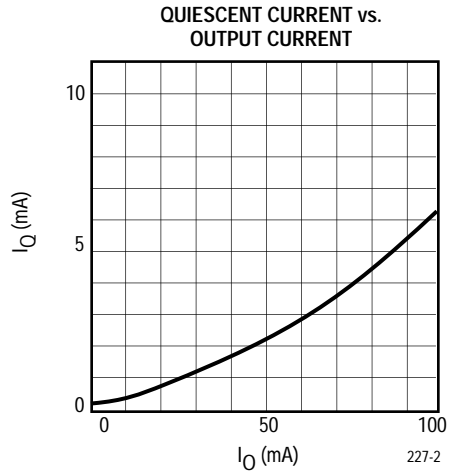
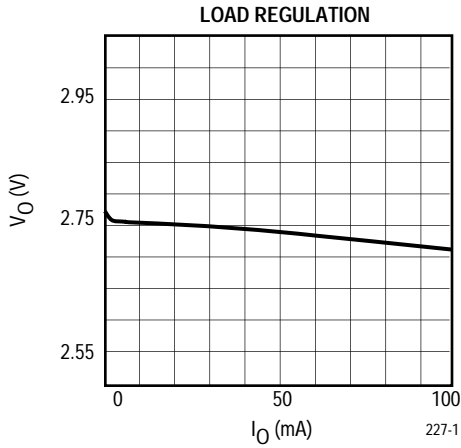

### TK11230

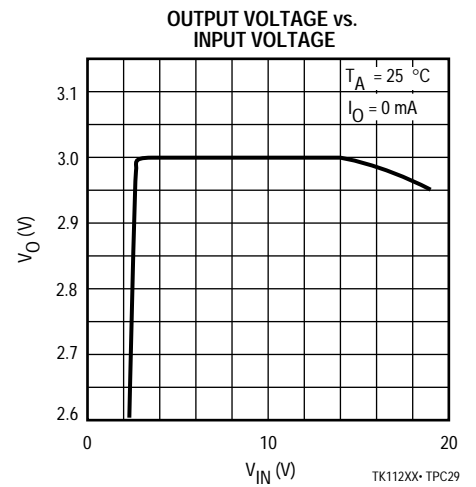
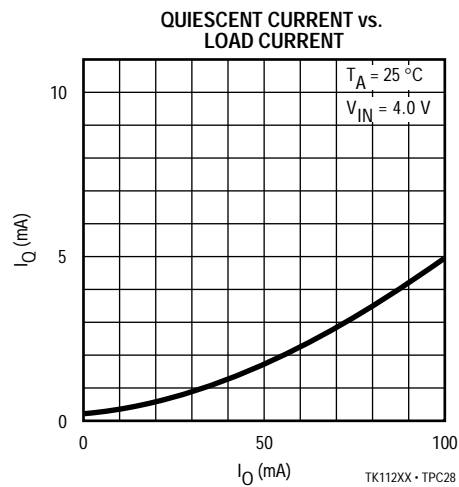
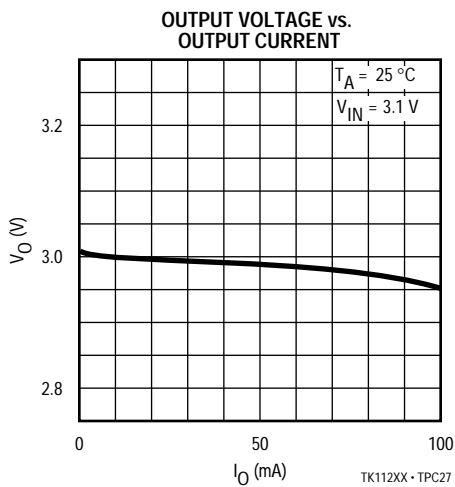

TYPICAL PERFORMANCE CHARACTERISTICS (CONT.)

$T_A = 25^\circ\text{C}$  unless otherwise specified.

TK11230 (CONT.)

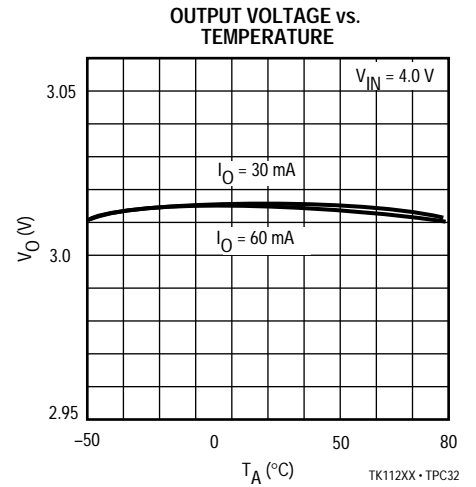
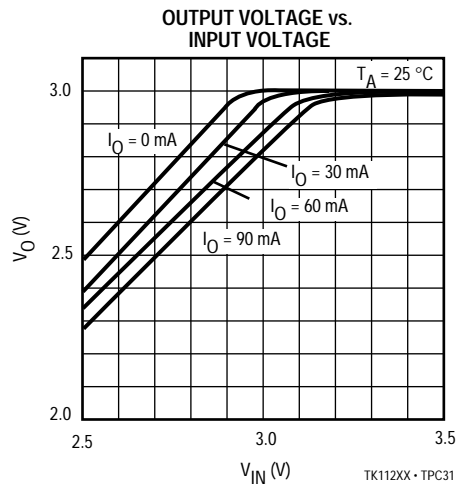
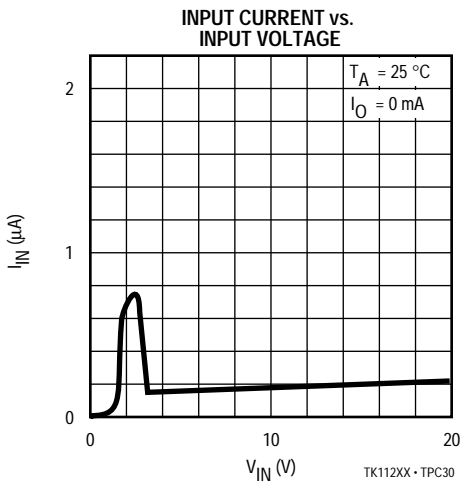

TK11232

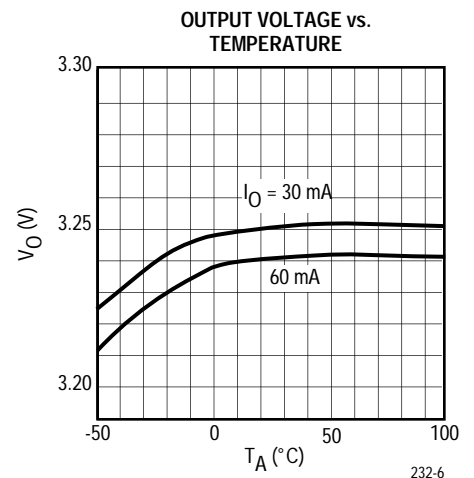
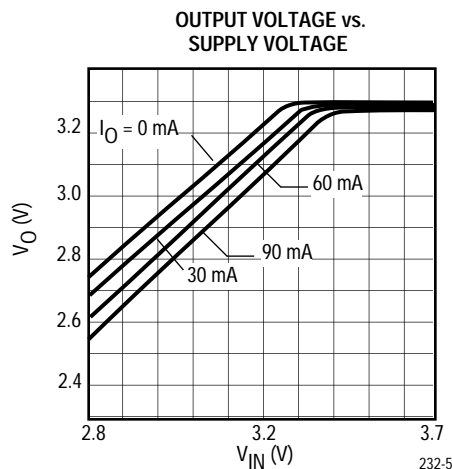
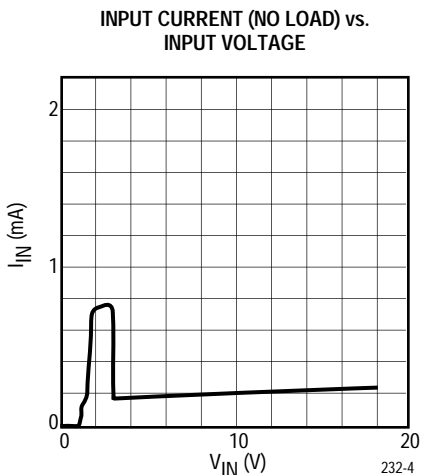
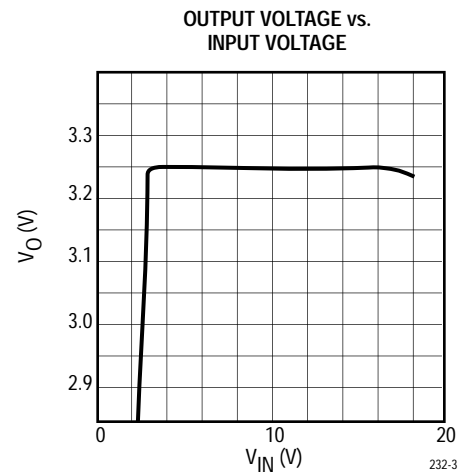
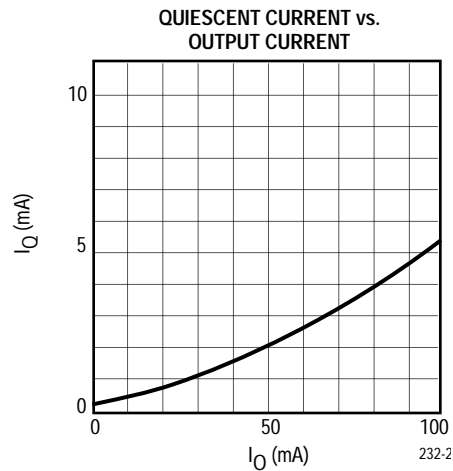
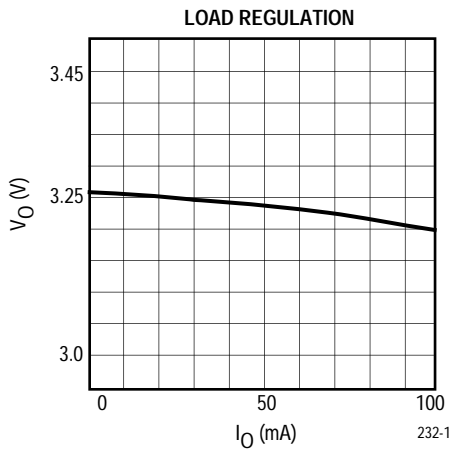

## TYPICAL PERFORMANCE CHARACTERISTICS (CONT.)

$T_A = 25^\circ\text{C}$  unless otherwise specified.

### TK11235

LOAD REGULATION

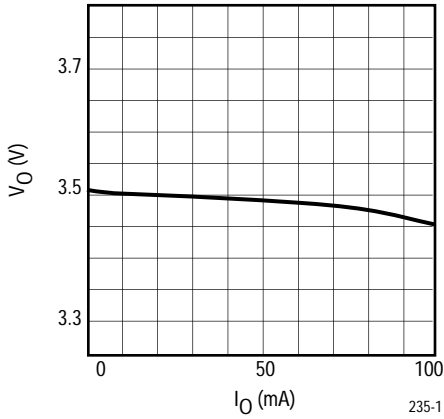

QUIESCENT CURRENT vs. OUTPUT CURRENT

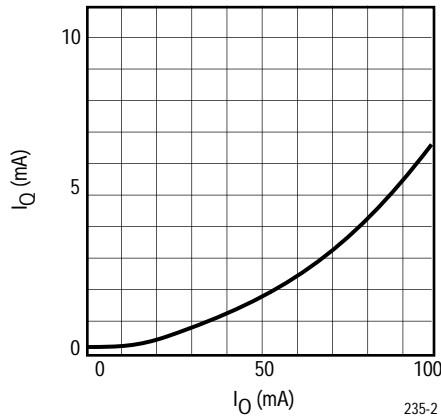

OUTPUT VOLTAGE vs. INPUT VOLTAGE

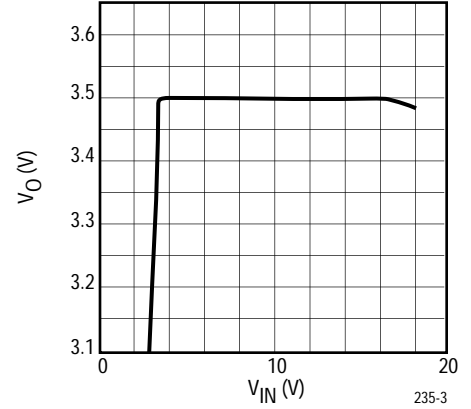

INPUT CURRENT (NO LOAD vs. SUPPLY VOLTAGE)

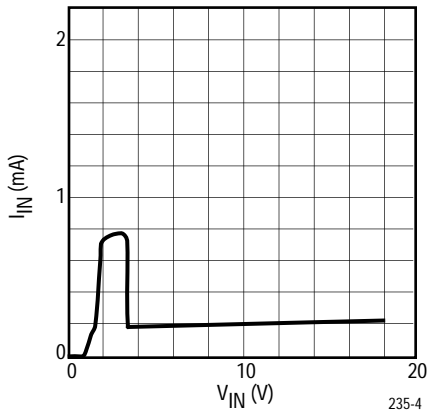

OUTPUT VOLTAGE vs. INPUT VOLTAGE

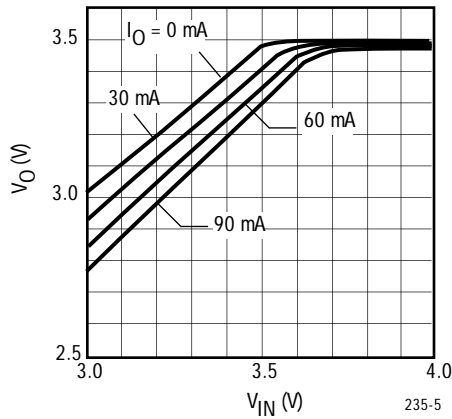

OUTPUT VOLTAGE vs. TEMPERATURE

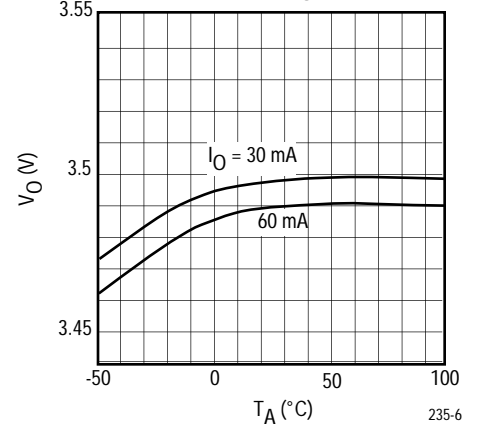

### TK11240

LOAD REGULATION

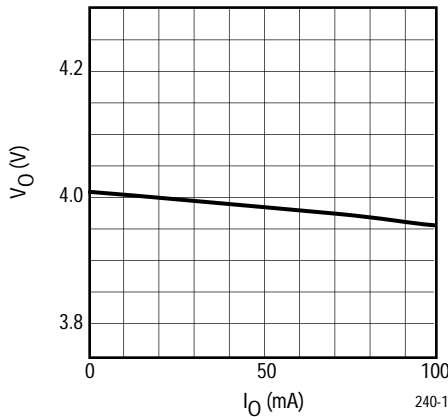

QUIESCENT CURRENT vs. OUTPUT CURRENT

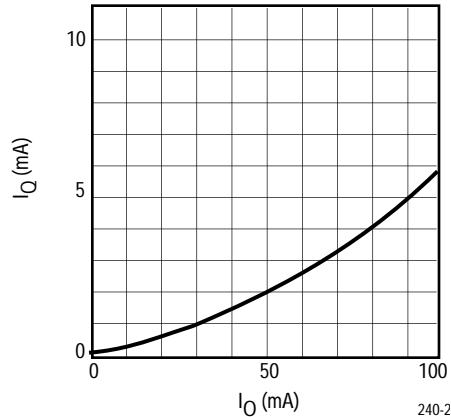

OUTPUT VOLTAGE vs. INPUT VOLTAGE

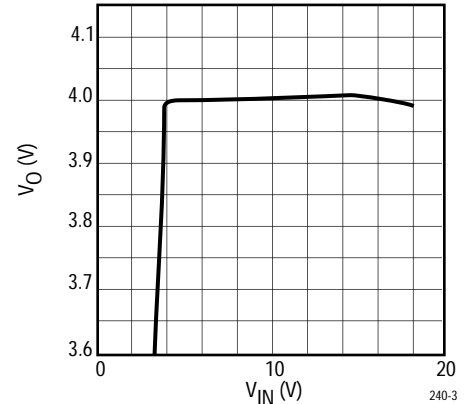

**TYPICAL PERFORMANCE CHARACTERISTICS (CONT.)**

$T_A = 25^\circ\text{C}$  unless otherwise specified.

**TK11240 (CONT.)**

SUPPLY VOLTAGE vs. INPUT CURRENT (NO LOAD)

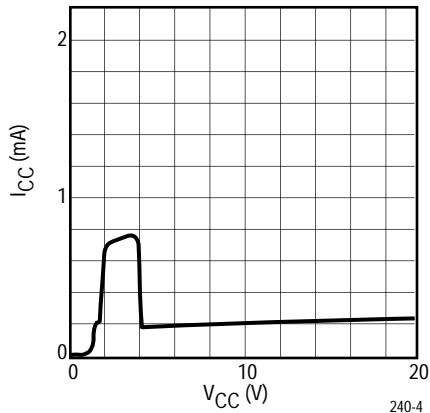

SUPPLY VOLTAGE vs. OUTPUT VOLTAGE

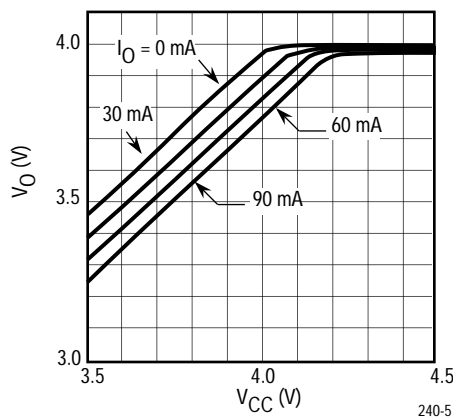

TEMPERATURE vs. OUTPUT VOLTAGE

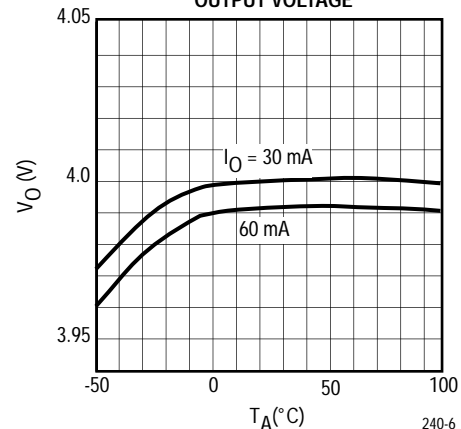

**TK11245**

LOAD REGULATION

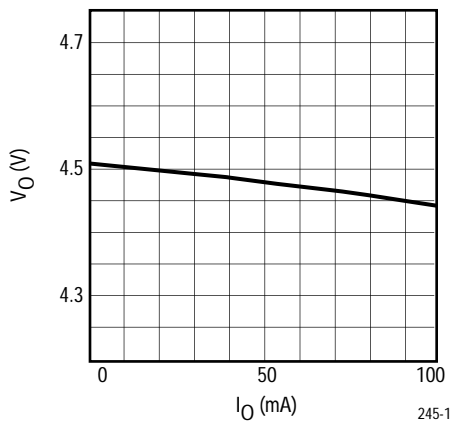

QUIESCENT CURRENT vs. OUTPUT CURRENT

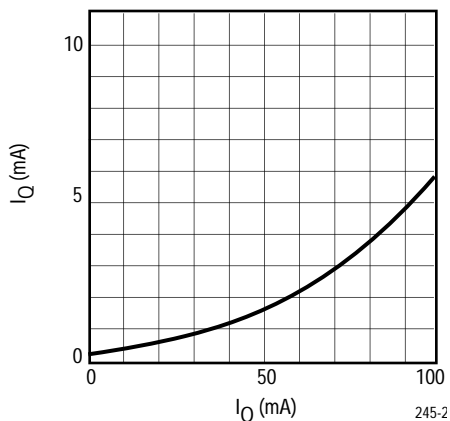

OUTPUT VOLTAGE vs. INPUT VOLTAGE

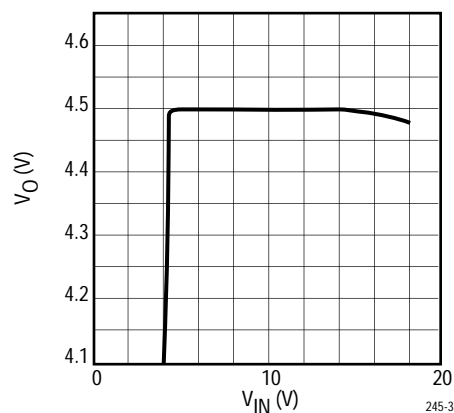

INPUT CURRENT (NO LOAD) vs. INPUT VOLTAGE

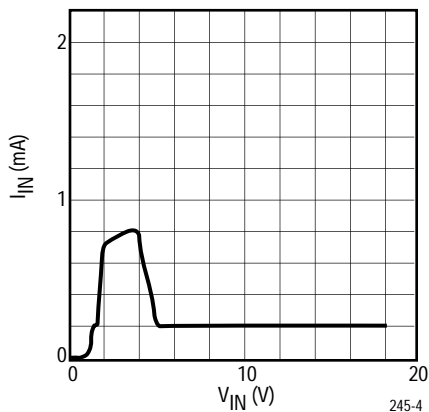

OUTPUT VOLTAGE vs. INPUT VOLTAGE

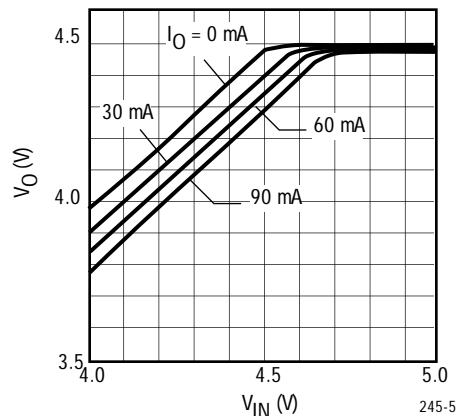

OUTPUT VOLTAGE vs. TEMPERATURE

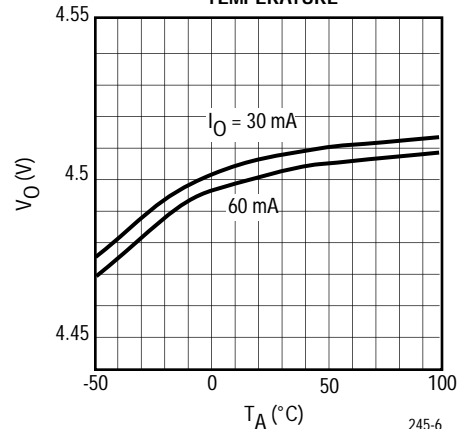

## TYPICAL PERFORMANCE CHARACTERISTICS (CONT.)

$T_A = 25^\circ\text{C}$  unless otherwise specified.

TK11247

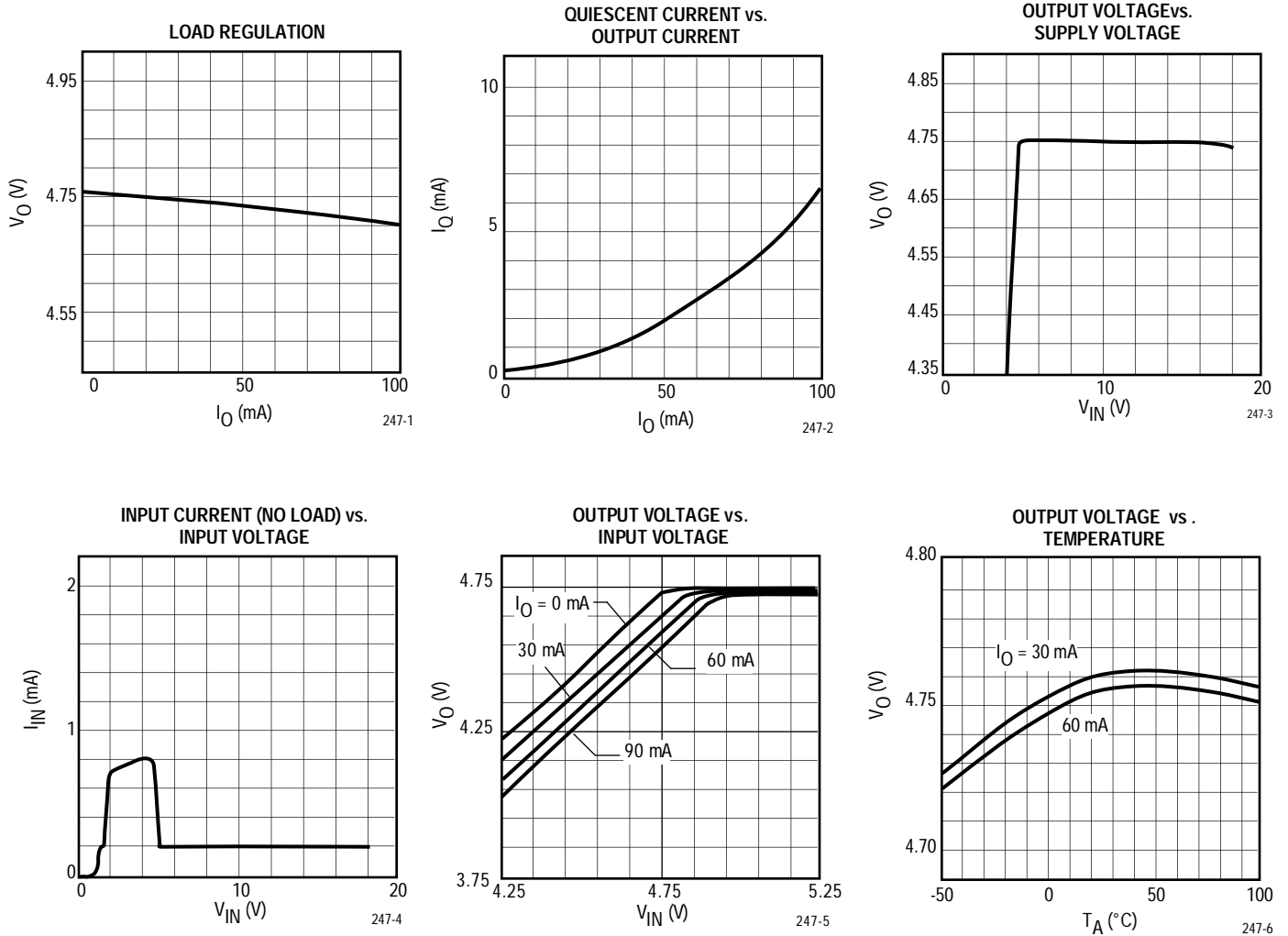

TK11250

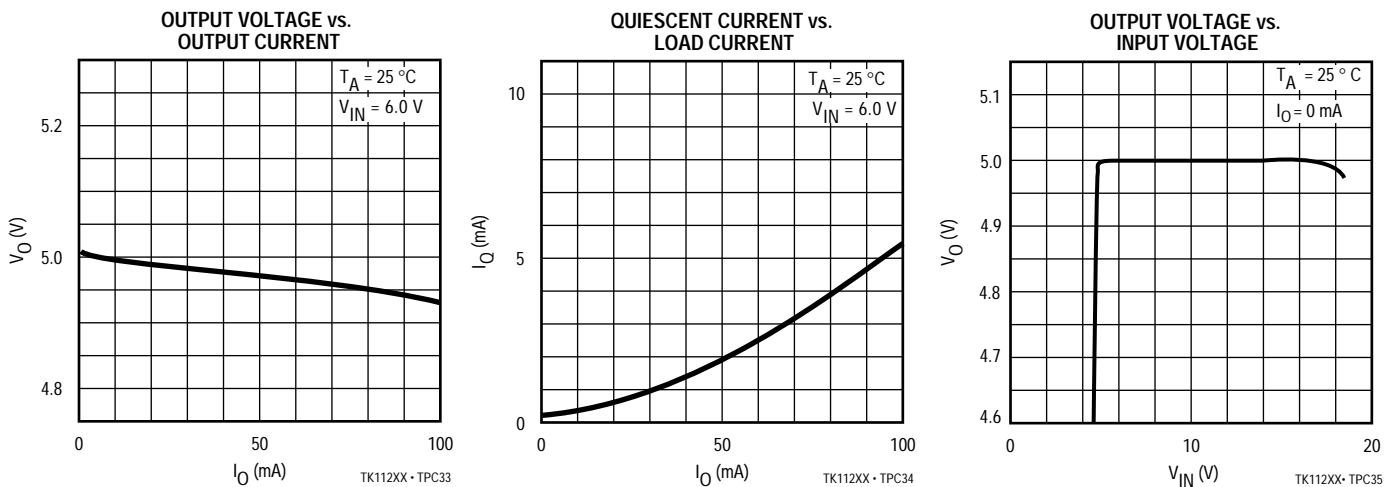



## TYPICAL PERFORMANCE CHARACTERISTICS (CONT.)

 $T_A = 25\text{ }^\circ\text{C}$  unless otherwise specified.

## TK11250 (CONT.)

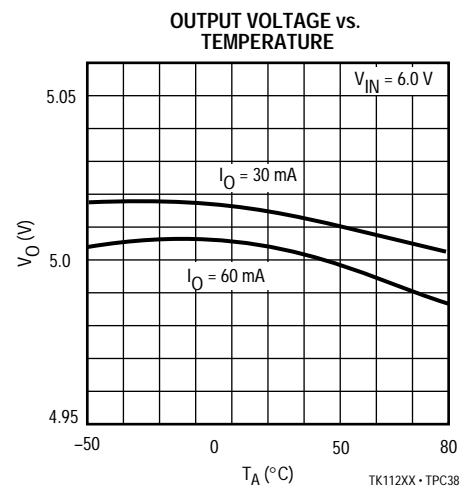
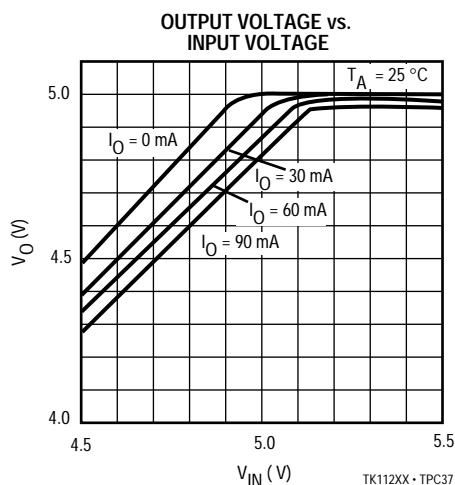
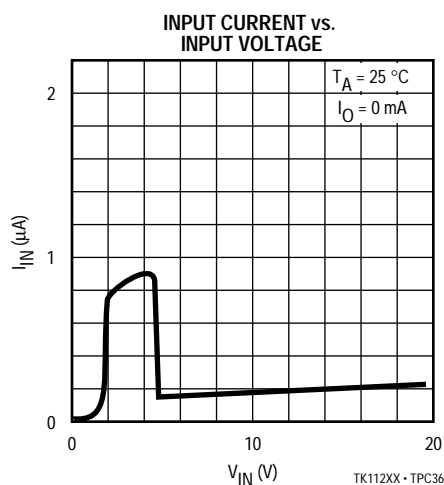

## DEFINITION AND EXPLANATION OF TECHNICAL TERMS

## LINE REGULATION (LINE REG)

Line regulation is the relationship between change in output voltage due to a change in input voltage.

## LOAD REGULATION (LOAD REG)

Load regulation is the relationship between change in output voltage due to a change in load current.

DROP OUT VOLTAGE ( $V_{\text{DROP}}$ )

This is a measure of how well the regulator performs as the input voltage decreases. The smaller the number, the further the input voltage can decrease before regulation problems occur. Nominal output voltage is first measured when  $V_{IN} = V_O + 1$  at a chosen load current. When the output voltage has dropped 100 mV from the nominal,  $V_{IN} - V_O$  is the dropout voltage. This voltage is affected by load current and junction temperature.

## OUTPUT NOISE VOLTAGE

This is the effective AC voltage that occurs on the output voltage under the condition where the input noise is low and with a given load, filter capacitor, and frequency range.

## THERMAL PROTECTION

This is an internal feature which turns the regulator off when the junction temperature rises above  $150\text{ }^\circ\text{C}$ . After the regulator turns off, the temperature drops and the regulator

output turns back on. Under certain conditions, the output waveform may appear to be an oscillation as the output turns off and on and back again in succession.

PACKAGE POWER DISSIPATION ( $P_D$ )

This is the power dissipation level at which the thermal sensor is activated. The IC contains an internal thermal sensor which monitors the junction temperature. When the junction temperature exceeds the monitor threshold of  $150\text{ }^\circ\text{C}$ , the IC is shutdown. The junction temperature rises as the difference between the input power ( $V_{IN} \times I_{IN}$ ) and the output power ( $V_O \times I_O$ ) increases. The rate of temperature rise is greatly affected by the mounting pad configuration on the PCB, the board material, and the ambient temperature. When the IC mounting has good thermal conductivity, the junction temperature will be low even if the power dissipation is great. When mounted on the recommended mounting pad, the power dissipation of the SOT-23L is increased to 400 mW. For operation at ambient temperatures over  $25\text{ }^\circ\text{C}$ , the power dissipation of the SOT-23L device should be derated at  $3.2\text{ mW}/^\circ\text{C}$ . To determine the power dissipation for shutdown when mounted, attach the device on the actual PCB and deliberately increase the output current (or raise the input voltage) until the thermal protection circuit is activated. Calculate the power dissipation of the device by subtracting the output power from the input power. These measurements should allow for the ambient temperature of the PCB. The value obtained from  $P_D/(150\text{ }^\circ\text{C} - T_A)$  is the derating factor. The PCB mounting pad should provide maximum thermal conductivity in order to maintain low device temperatures. As a general rule, the

## DEFINITION AND EXPLANATION OF TECHNICAL TERMS (CONT.)

lower the temperature, the better the reliability of the device. The Thermal resistance when mounted is expressed as follows:

$$T_J = \theta_{JA} \times P_D + T_A$$

For Toko ICs, the internal limit for junction temperature is 150 °C. If the ambient temperature,  $T_A$  is 25 °C, then:

$$150 \text{ °C} = \theta_{JA} \times P_D + 25 \text{ °C}$$

$$\theta_{JA} \times P_D = 125 \text{ °C}$$

$$\theta_{JA} = 125 \text{ °C} / P_D$$

$P_D$  is the value when the thermal sensor is activated. A simple way to determine  $P_D$  is to calculate  $V_{IN} \times I_{IN}$  when the output side is shorted. Input current gradually falls as temperature rises. You should use the value when thermal equilibrium is reached.

The range of currents usable can also be found from the graph below.

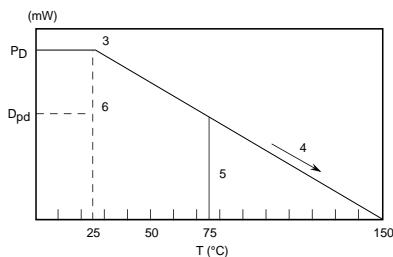

Procedure:

- 1.) Find  $P_D$
- 2.)  $P_{D1}$  is taken to be  $P_D \times (\approx 0.8 \sim 0.9)$
- 3.) Plot  $P_{D1}$  against 25 °C
- 4.) Connect  $P_{D1}$  to the point corresponding to the 150 °C with a straight line.
- 5.) In design, take a vertical line from the maximum operating temperature (e.g. 75 °C) to the derating curve.
- 6.) Read off the value of  $P_D$  against the point at which the vertical line intersects the derating curve. This is taken as the maximum power dissipation,  $D_{PD}$ .

The maximum operating current is  $I_O \times (D_{PD} / (V_{IN(MAX)} - V_O))$ .

## INPUT/OUTPUT DECOUPLING CAPACITOR CONSIDERATIONS

Voltage regulators require input and output decoupling capacitors. The required value of these capacitors vary with application. Capacitors made by different manufacturers can have different characteristics, particularly with regard to high frequencies and equivalent resistance (ESR) over temperature. The type of capacitor is also important. For example, a 5.6  $\mu\text{F}$  aluminum electrolytic may be required for a certain application. If a tantalum capacitor is used, a lower value of 3.3  $\mu\text{F}$  would be adequate. It is important to consider the temperature characteristics of the decoupling capacitors. While Toko regulators are designed to operate as low as -30 °C, many capacitors will not operate properly at this temperature. The capacitance of aluminum electrolytic capacitors may decrease to 0 at low temperatures. This may cause oscillation on the output of the regulator since some capacitance is required to guarantee stability. Thus, it is important to consider the characteristics of the capacitor over temperature when selection decoupling capacitors. The ESR is another important parameter. The ESR will increase with temperature but low ESR capacitors are often larger and more costly. In general, Tantalum capacitors offer lower ESR than aluminum electrolytic, but new low ESR aluminum electrolytic capacitors are now available from several manufacturers. Usually a bench test is sufficient to determine the minimum capacitance required for a particular application. After taking thermal characteristics and tolerance into account, the minimum capacitance value should be approximately two times this value. The recommended minimum capacitance for the TK112xx is 3.3  $\mu\text{F}$ . Please note that linear regulators with a low dropout voltage have high internal loop gains which requires care in guarding against oscillation caused by insufficient decoupling capacitance. The use of high quality decoupling capacitors suited for your application will guarantee proper operation of the circuit.

## NOISE BYPASS CAPACITOR SECTION

The noise bypass capacitor ( $C_P$ ) should be connected as close as possible to pin 3 and ground. The recommended value for  $C_P$  is 0.01  $\mu\text{F}$ . The noise bypass terminal has a high impedance and care should be taken if the noise bypass capacitor is not used. This terminal is susceptible to external noise and oscillation can occur when  $C_P$  is not used and the solder pad for this pin is made too large.

## APPLICATION INFORMATION

### 1.) Disabling the control pin

Connect control terminal to  $V_{IN}$  through a resistor (R). Higher resistance values are good for reducing quiescent current but this can cause the regulator to shut down at lower input voltages. See Figure A.

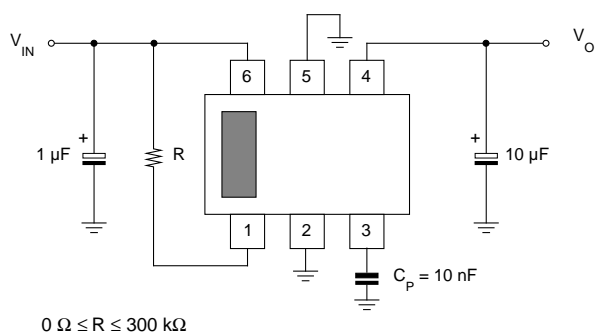

Figure A

### 2.) Using the control function

Turn on the regulator by setting the control pin voltage to 2.4 V or higher. Turn off the regulator by pulling the control pin below 0.6 V. The regulator can also be controlled directly from a TTL or CMOS device. See Figure B.

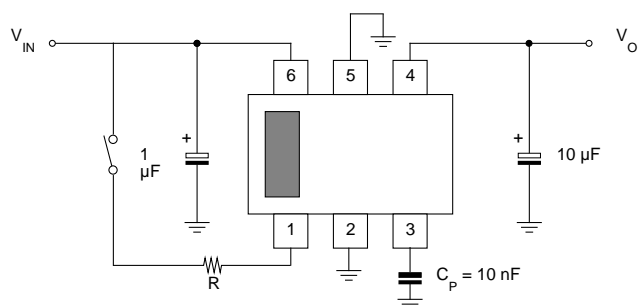
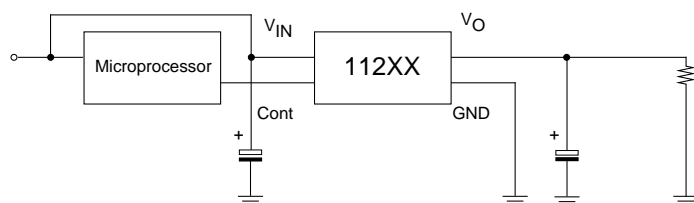

Figure B

### 3.) Microprocessor/Logic Control



The Input and Control current in the off mode are less than 200 pA.

### 4.) Parallel connection for ON/OFF control

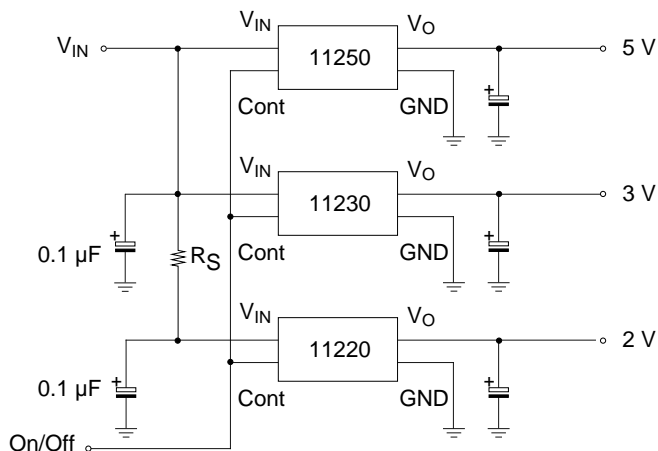

To reduce IC power dissipation, connect a resistor,  $R_S$ , in series with  $V_{IN}$  for the lower output voltage devices. This will prevent thermal shutdown due to excessive power dissipation.

### 5.) Constant current load

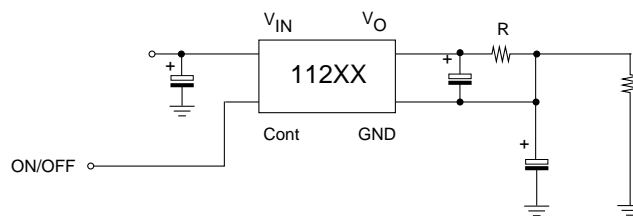

When there is a large output current, the quiescent current also increases, and the difference becomes larger. When using the ON/OFF control, the terminal voltage should be set 2.4 V higher than the GND terminal of the IC. When the ON/OFF control is not being used, connect it to  $V_{IN}$ .

## APPLICATION INFORMATION (CONT.)

### 6.) Heat dissipation

Make the copper pattern as large as possible to provide good heat dissipation (pin 5 is the heatsink).

Maximum power dissipation = 400 mW (When mounted as recommended) See Figure C.

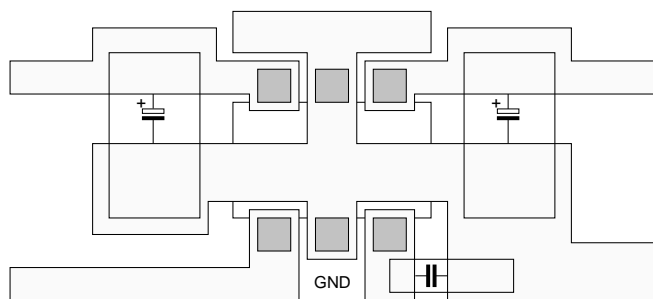

Figure C

### 7.) Handling molded resin packages

All plastic molded packages absorb some moisture from the air. If moisture absorption occurs prior to soldering the device into the printed circuit board, increased separation of the lead from the plastic molding may occur, degrading the moisture barrier characteristics of the device. This property of plastic molding compounds should not be overlooked, particularly in the case of very small packages, where the plastic is very thin. In order to preserve the original moisture barrier properties of the package, devices are stored and shipped in moisture proof bags, filled with dry air. The bags should not be opened or damaged prior to the actual use of the devices. If this is unavoidable, the devices should be stored in a low relative humidity environment (40 to 65%) or in an enclosed environment with desiccant.

PACKAGE OUTLINE

SOT23L

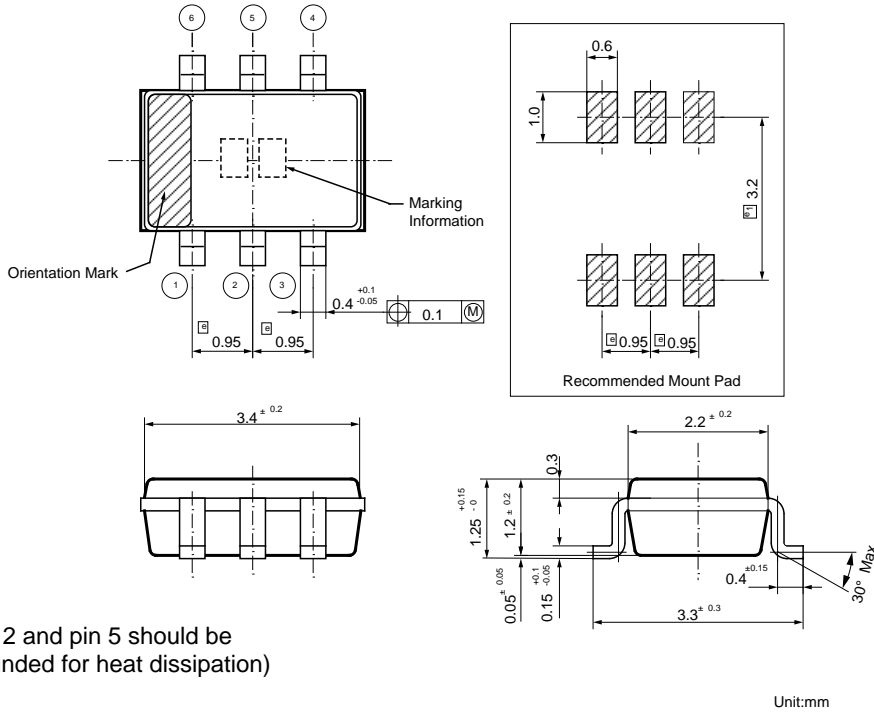

(Pin 2 and pin 5 should be grounded for heat dissipation)

Marking Information

11227	$\overline{P2}$
11230	$P3$
11232	$P\overline{3}$
11235	$P\overline{3}$
11240	$P4$
11245	$P\overline{4}$
11247	$\overline{P4}$
11250	$P5$

The information furnished by TOKO, Inc. is believed to be accurate and reliable. However, TOKO reserves the right to make changes or improvements in the design, specification or manufacture of its products without further notice. TOKO does not assume any liability arising from the application or use of any product or circuit described herein, nor for any infringements of patents or other rights of third parties which may result from the use of its products. No license is granted by implication or otherwise under any patent or patent rights of TOKO, Inc.



YOUR LOCAL REPRESENTATIVE IS:

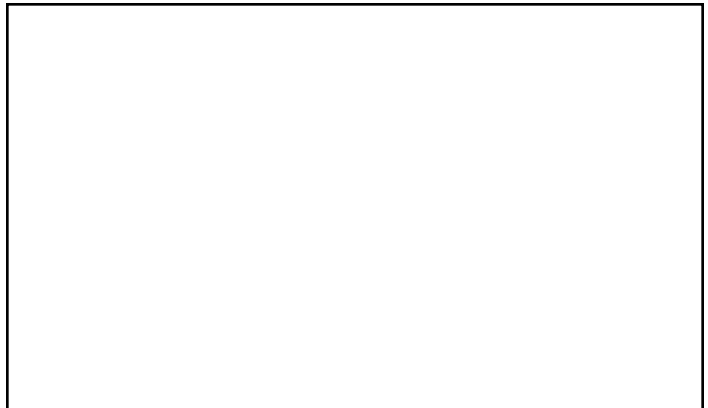

TOKO America, Inc.  
1250 Feehanville Dr.  
Mt. Prospect, ILL 60056

Tel: 1(800) PIK-TOKO  
Fax: 1(847) 699-1194