

75 Ω VIDEO LINE DRIVER

FEATURES

- Internal 75 Ω Driver
- Active High ON/OFF Control with Internal Pull-up
- Very Low Standby Current (typ. $I_{STBY} \leq 25 \mu A$)
- Very Small SOT23-6 Package
- Single +5 V Power Supply Operation

APPLICATIONS

- Video Equipment
- Digital Cameras
- CCD Cameras
- TV Monitors
- Video Tape Recorders
- LCD Projectors

DESCRIPTION

Operating from a single +5 V supply, the TK15406 is a single-channel video line driver IC that takes a standard video analog input and provides a buffered analog output for driving a 150 Ω load. The standard video input signal (1 V_{P-P} typical) is internally biased at 2.5 V and amplified 6 dB to produce 2 V_{P-P} (typical) into a series 75 Ω resistor and 75 Ω cable load. During standby (Pin 1 grounded), the TK15406 consumes only 120 μW of power. Nominal power dissipation (no input) is typically 32 mW.

The TK15406M is available in the very small SOT23-6 surface mount package.

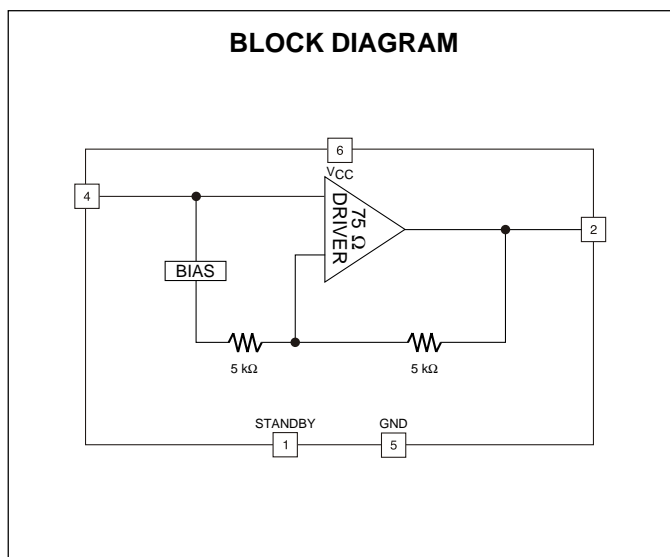
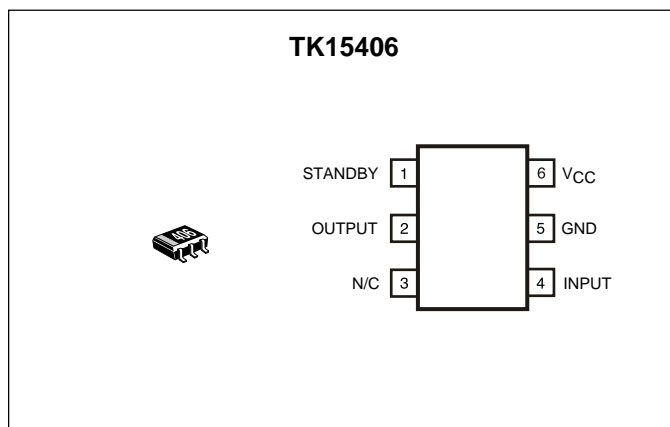

ORDERING INFORMATION

TK15406M □□

Tape/Reel Code

TAPE/REEL CODE
TL: Tape Left

TK15406

TK15406M ABSOLUTE MAXIMUM RATINGS

Supply Voltage 6 V Storage Temperature Range -55 to +150 °C
Operating Voltage 4.5 to 5.5 V Operating Temperature Range -25 to +75 °C
Power Dissipation (Note 1) 150 mW

TK15406M ELECTRICAL CHARACTERISTICS

Test conditions: $V_{CC} = 5.0\text{ V}$, $V_{IN} = 1.0\text{ V}_{P-P}$, $R_L = 150\ \Omega$, $T_A = 25\text{ °C}$ unless otherwise specified.

SYMBOL	PARAMETER	TEST CONDITIONS	MIN	TYP	MAX	UNITS
I_{CC}	Supply Current	No input		6.3	8.5	mA
I_{STBY}	Standby Supply Current	Pin 1 Grounded		24.0	50.0	μA
I_{OS}	Standby Terminal Current	Pin 1 in Standby mode		24.0	50.0	μA
V_{THL}	Standby Threshold Voltage (High to Low)	Pin 1 Operating to Standby mode	GND	0.1	0.3	V
V_{TLH}	Standby Threshold Voltage (Low to High)	Pin 1 Standby to Operating mode	1.8	2.0	V_{CC}	V
V_{BIAS}	Bias Voltage	Pin 4 Input terminal	2.15	2.45	2.75	V
GVA	Voltage Gain	$f_{in} = 1\text{ MHz}$	5.2	5.7	6.2	dB
fr	Frequency Response	$f_{in} = 1\text{ MHz} / 5\text{ MHz}$		-0.5		dB
THD	Total Harmonic Distortion	$f_{in} = 1.0\text{ kHz}$		0.2	1.0	%
$V_{OUT(MAX)}$	Maximum Output Voltage	THD = 10% point	1.0	1.2		Vrms

Note 1: Power dissipation is 150 mW in free air. Derate at 1.2 mW/°C for operation above 25°C.

TEST CIRCUIT

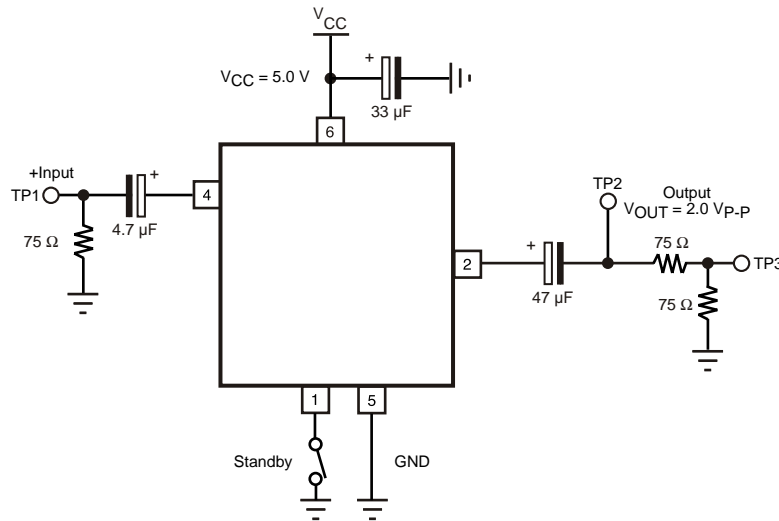

MEASUREMENT METHOD

1. Supply Current (I_{CC})

The Pin 6 current is measured with no input signal and the Standby Pin (Pin 1) open.

2. Standby Supply Current (I_{STBY})

The Pin 6 current is measured when the Standby Pin (Pin 1) is connected to ground.

3. Standby Terminal Current (I_{OS})

The Pin 1 current is measured when Pin 1 is connected to ground.

4. Threshold Voltage (High to Low) (V_{THL})

The Pin 1 voltage is measured at the point which changes the device from operating mode into standby mode.

5. Threshold Voltage (Low to High) (V_{TLH})

The Pin 1 voltage is measured at the point which changes the device from standby mode into operating mode.

6. Bias Voltage (V_{BIAS})

The DC voltage at Pin 4 is measured with no input signal.

7. Voltage Gain (GVA)

The voltage gain equation is as follows:

$$GVA = 20 \log_{10} V_2/V_1$$

Where V_1 is the input voltage at TP1 and V_2 is the measured output voltage at TP2.

8. Frequency Response (fr)

The frequency response equation is as follows:

$$fr = 20 \log_{10} V_2/V_1$$

Where V_1 is the measured TP3 voltage when the TP1 input frequency is set to 1 MHz and V_2 is the measured TP3 voltage when the TP1 input frequency is set to 5 MHz.

9. Total Harmonic Distortion (THD)

The TP3 signal is measured when a 1 kHz 1 V_{p-p} input signal is applied to TP1.

10. Maximum Output Voltage ($V_{OUT(MAX)}$)

A 1 kHz input signal is applied to TP1 and the amplitude is slowly increased. The output voltage at TP2 is measured at the point the THD reaches 10%.

TYPICAL PERFORMANCE CHARACTERISTICS

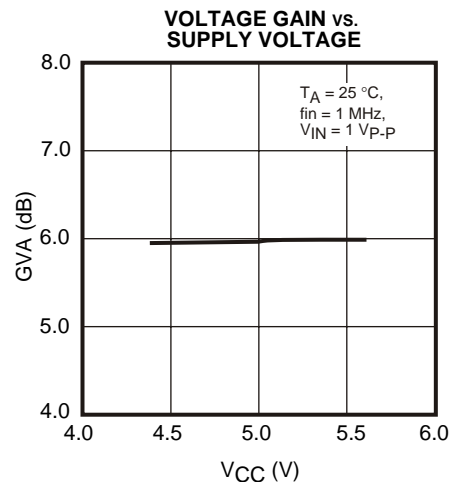
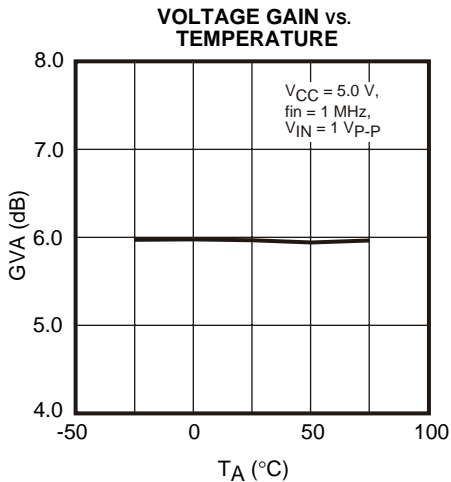
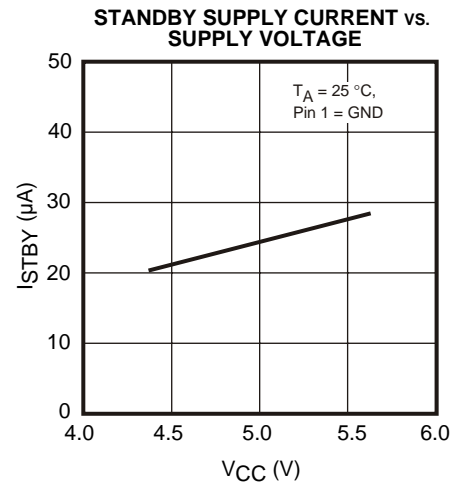
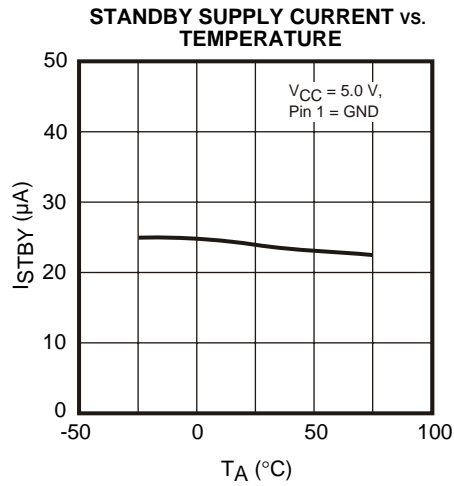
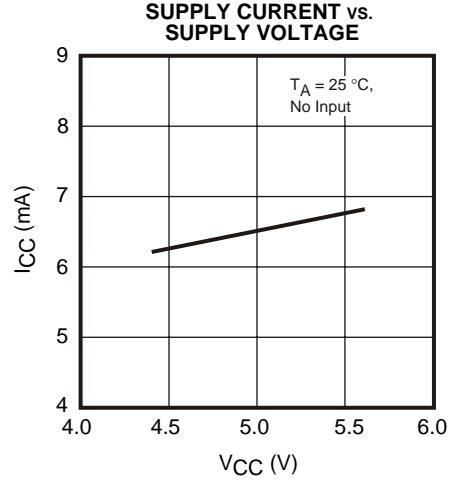
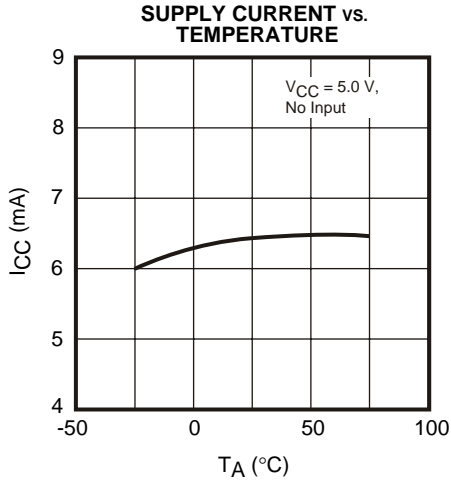

TYPICAL PERFORMANCE CHARACTERISTICS (CONT.)

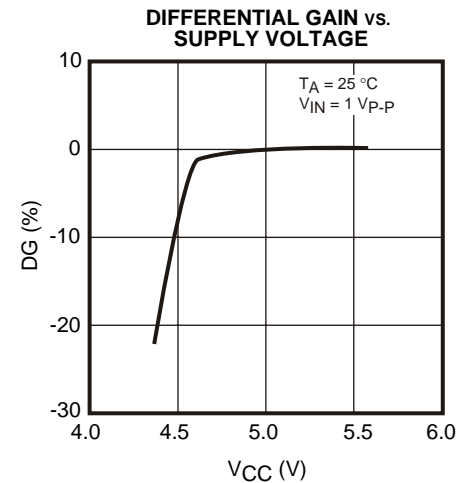
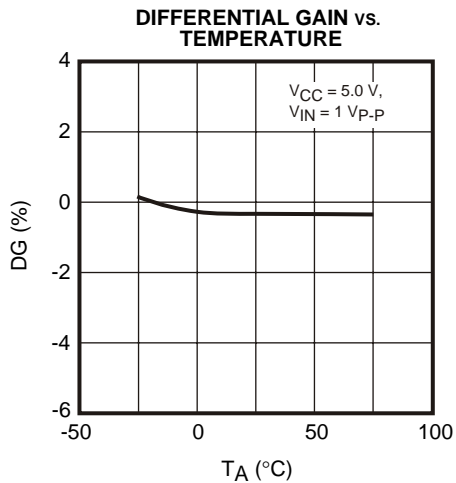
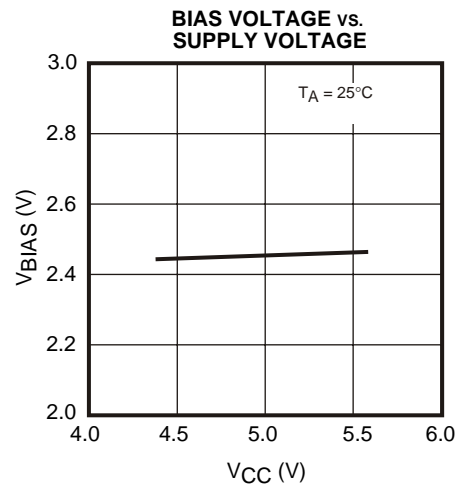
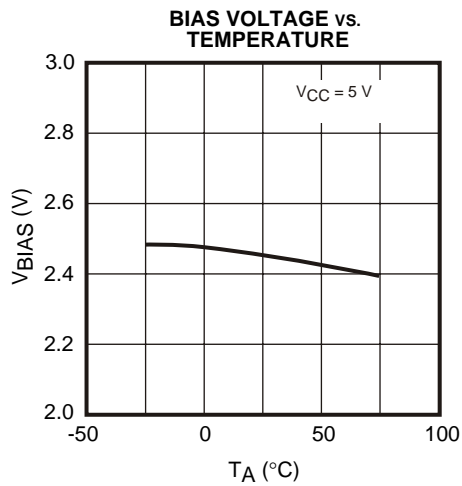
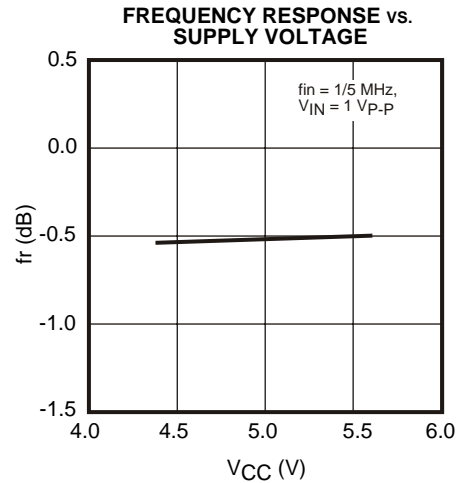
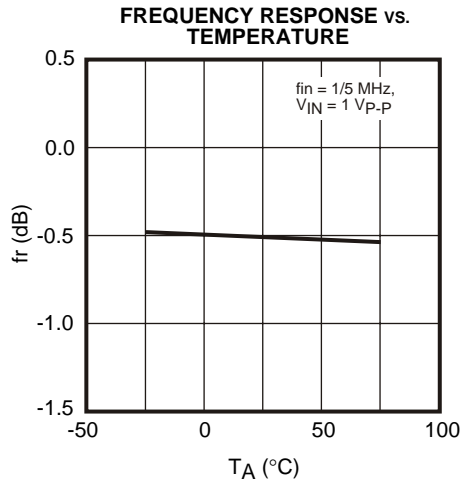

TYPICAL PERFORMANCE CHARACTERISTICS (CONT.)

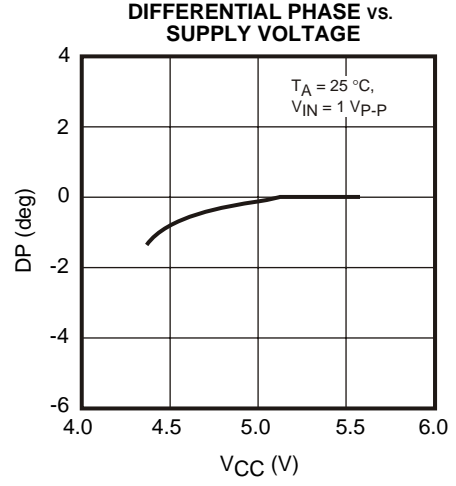
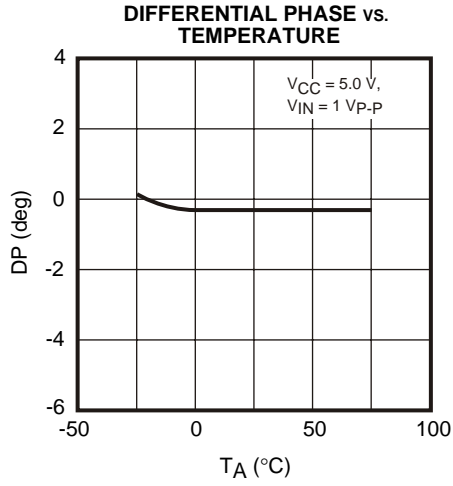

PIN FUNCTION DESCRIPTION

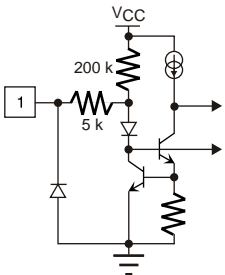
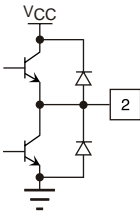
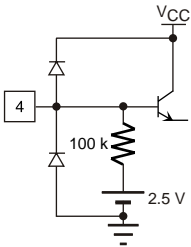
TERMINAL			INTERNAL EQUIVALENT CIRCUIT	DESCRIPTION
PIN NO.	SYMBOL	VOLTAGE		
1	STANDBY	1.4 V		Standby Logic Terminal. The device is in the standby mode when Pin 1 is connected to Low. The device is in the operating mode when Pin 1 is connected to High or Open.
2	OUTPUT	2.5 V		Output Terminal. The output is available to drive a $75\ \Omega + 75\ \Omega$ load.
3	NC			No Connection Terminal
4	INPUT	2.5 V		Input Terminal. The input signal is biased to 2.5 V by a 100 kΩ bias resistor.
5	GND	GND		GND Terminal
6	V_{CC}	V_{CC}		Power Supply Terminal

PACKAGE OUTLINE

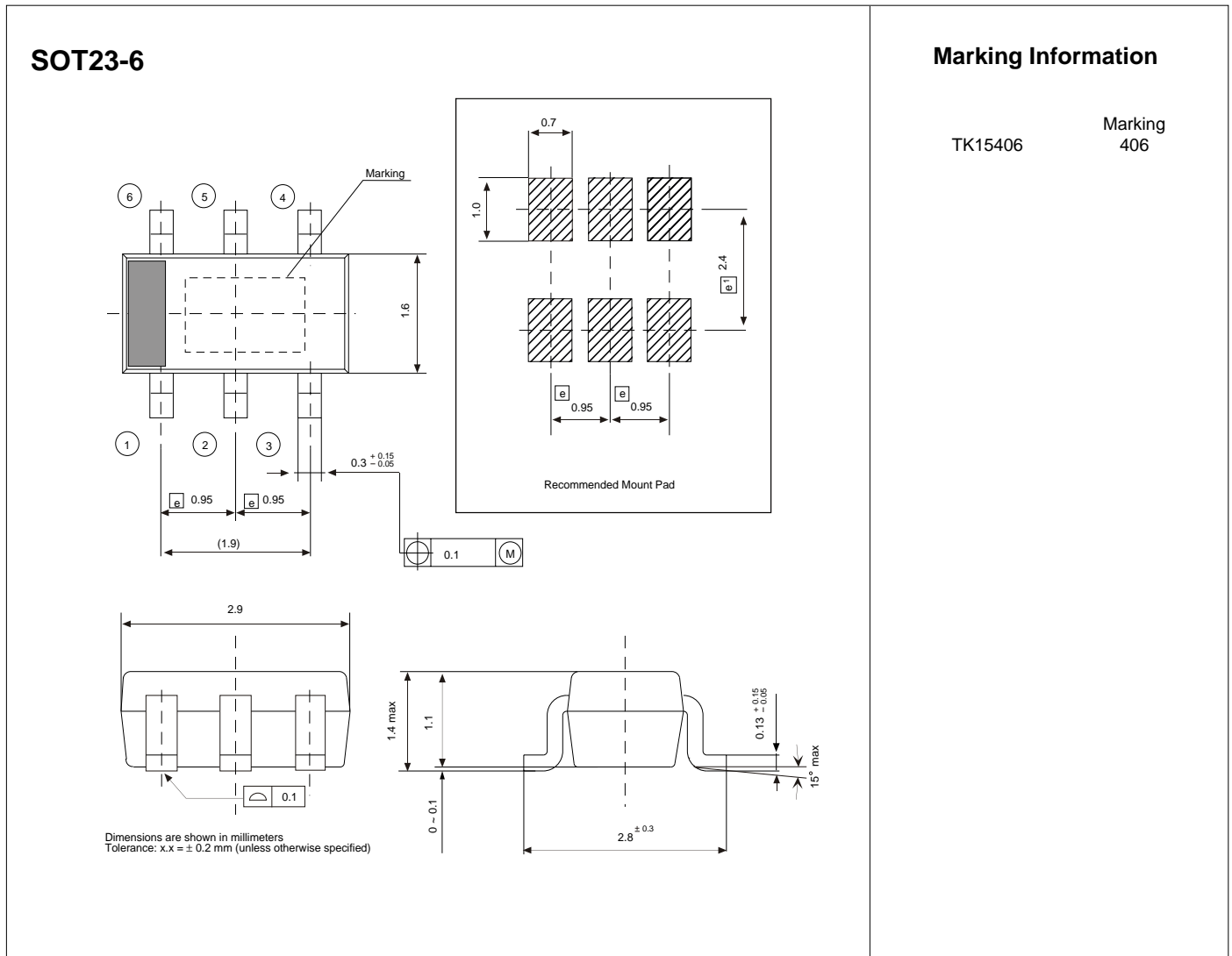

Toko America, Inc. Headquarters
1250 Feehanville Drive, Mount Prospect, Illinois 60056
Tel: (847) 297-0070 Fax: (847) 699-7864

TOKO AMERICA REGIONAL OFFICES

Midwest Regional Office
Toko America, Inc.
1250 Feehanville Drive
Mount Prospect, IL 60056
Tel: (847) 297-0070
Fax: (847) 699-7864

Western Regional Office
Toko America, Inc.
2480 North First Street, Suite 260
San Jose, CA 95131
Tel: (408) 432-8281
Fax: (408) 943-9790

Eastern Regional Office
Toko America, Inc.
107 Mill Plain Road
Danbury, CT 06811
Tel: (203) 748-6871
Fax: (203) 797-1223

Semiconductor Technical Support
Toko Design Center
4755 Forge Road
Colorado Springs, CO 80907
Tel: (719) 528-2200
Fax: (719) 528-2375

Visit our Internet site at <http://www.tokoam.com>

The information furnished by TOKO, Inc. is believed to be accurate and reliable. However, TOKO reserves the right to make changes or improvements in the design, specification or manufacture of its products without further notice. TOKO does not assume any liability arising from the application or use of any product or circuit described herein, nor for any infringements of patents or other rights of third parties which may result from the use of its products. No license is granted by implication or otherwise under any patent or patent rights of TOKO, Inc.