

75 Ω VIDEO LINE DRIVER

FEATURES

- Internal Y-C Summing Circuit
- Internal Switch Circuit for Composite Signal or Y-C Signal
- Voltage Gain is 6 dB Fixed
- Internal 75 Ω Driver
- Very Small Output Capacitor Using SAG Function Pin
- Very Small Package (SOT23L-8)

APPLICATIONS

- Video Equipment
- Camcorder
- CCD Cameras
- DVD Player/RW
- Video Board
- Video Tape Recorders
- LCD TV/Monitor

DESCRIPTION

Operating from a single +5 V supply, the TK15415M is a 75 Ω video line driver IC with an internal Y-C summing circuit. It has an internal switch circuit for the CVBS composite signal and the Y-C signal. The internal 1.5 k SAG function resistor provides gain compensation for low frequency signals. (Voltage gain from the CVBS signal input terminal is 6 dB.)

The TK15415M is available in the very small SOT23L-8 surface mount package.

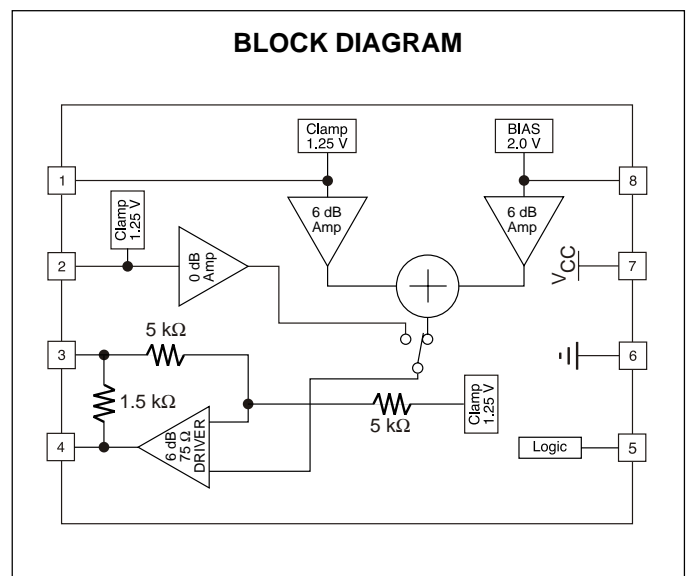
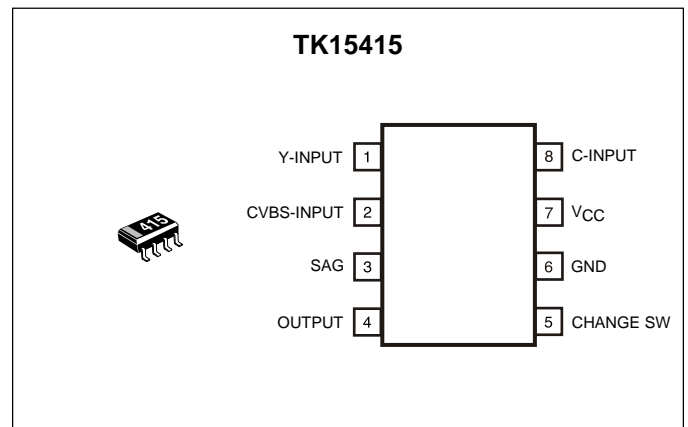

ORDERING INFORMATION

TK15415M □□

Tape/Reel Code

TAPE/REEL CODE
TL: Tape Left

TK15415

ABSOLUTE MAXIMUM RATINGS

Supply Voltage	6 V	Input Frequency	10.0 MHz
Operating Voltage Range	4.5 to 5.5 V	Storage Temperature Range	-55 to +150 °C
Power Dissipation (Note 1)	200 mW	Operating Temperature Range	-25 to +85 °C

TK15415M ELECTRICAL CHARACTERISTICS

Test conditions: $V_{CC} = 5.0\text{ V}$, $V_{IN} = 1.0\text{ V}_{P-P}$, $R_L = 150\ \Omega$, $T_A = 25\text{ °C}$ unless otherwise specified.

SYMBOL	PARAMETER	TEST CONDITIONS	MIN	TYP	MAX	UNITS
I_{CC}	Supply Current	No input		25.0	36.0	mA
$V_{THL(SW)}$	Switch Threshold Voltage (High to Low)	Pin 5, S-VHS to CVBS			0.3	V
$V_{TLH(SW)}$	Switch Threshold Voltage (Low to High)	Pin 5, CVBS to S-VHS	1.8			V
S-VHS (Pin 5 OPEN)						
V_{CMP}	Clamp Voltage	Pin 1, Y signal input terminal	1.10	1.28	1.50	V
V_{BIAS}	Bias Voltage	Pin 8, C signal input terminal	1.70	2.00	2.30	V
GVA-Y	Voltage Gain, Y channel	$f_{in} = 1\text{ MHz}$, Y signal input	5.2	5.7	6.2	dB
GVA-C	Voltage Gain, C channel	$f_{in} = 1\text{ MHz}$, C signal input	5.1	5.6	6.1	dB
DG-S	Differential Gain	Staircase signal input	-3.0	-1.5	+3.0	%
DP-S	Differential Phase	Staircase signal input	-3.0	0.0	+3.0	deg
fr-S	Frequency Response	$f_{in} = 1\text{ MHz} / 5\text{ MHz}$		-0.5		dB
CVBS (Pin 5 GND)						
V_{CMP}	Clamp Voltage	Pin 2, CVBS input terminal	1.10	1.28	1.50	V
GVA	Voltage Gain	$f_{in} = 1\text{ MHz}$	5.1	5.6	6.1	dB
DG	Differential Gain	Staircase signal input	-3.0	-0.6	+3.0	%
DP	Differential Phase	Staircase signal input	-3.0	0.2	+3.0	deg
fr	Frequency Response	$f_{in} = 1\text{ MHz} / 5\text{ MHz}$		-0.5		dB

Note 1: Power dissipation is 200 mW in free air. Derate at 1.6 mW/°C for operation above 25°C.

TEST CIRCUIT

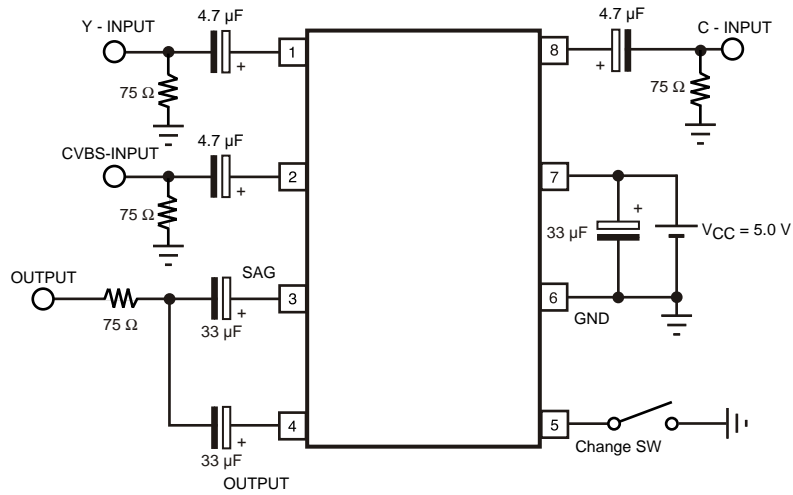

TYPICAL PERFORMANCE CHARACTERISTICS

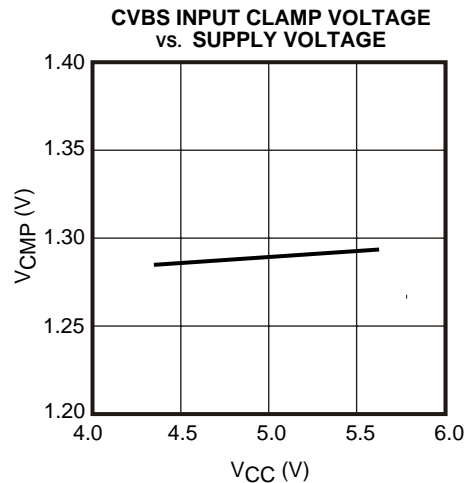
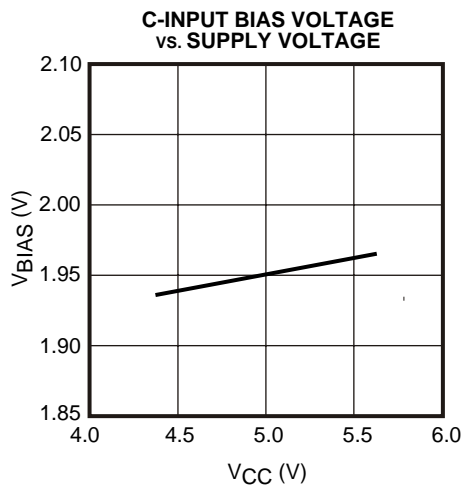
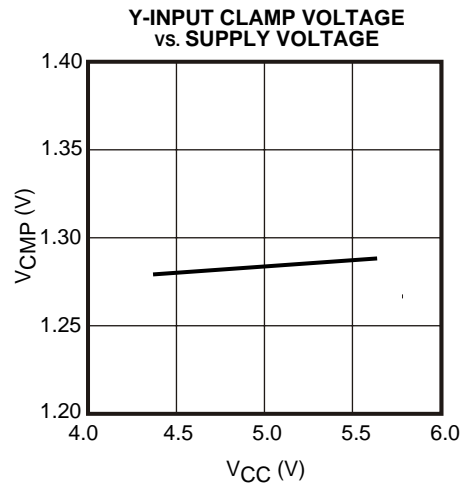
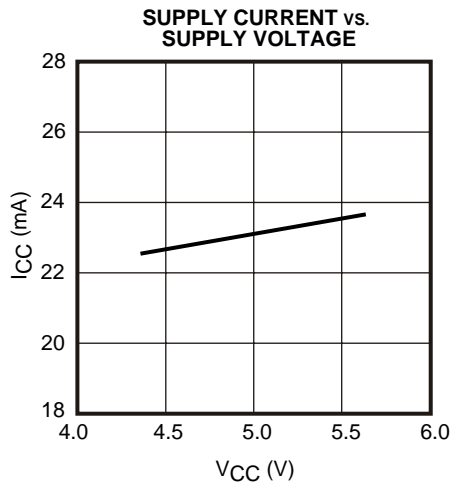

TYPICAL PERFORMANCE CHARACTERISTICS

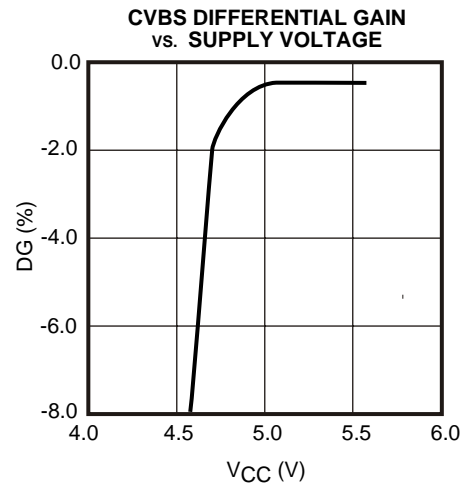
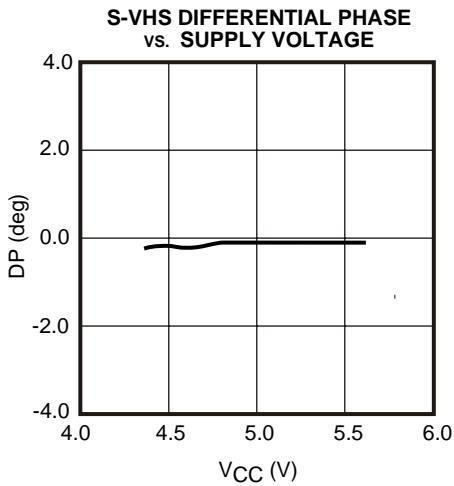
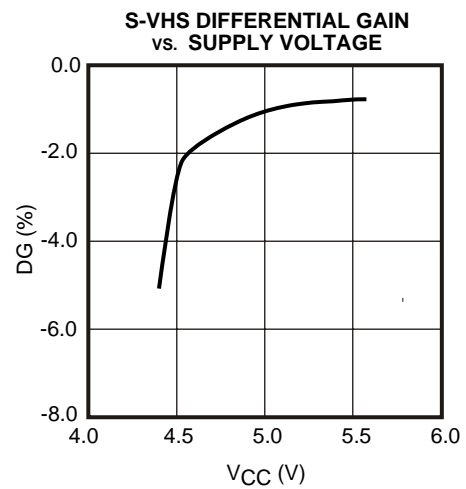
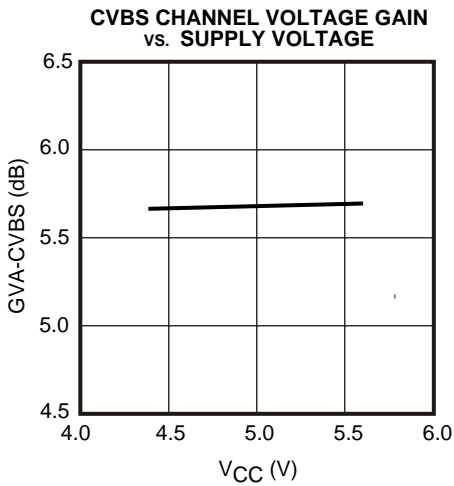
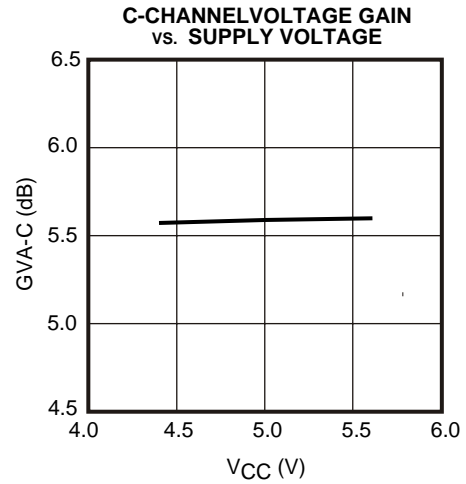
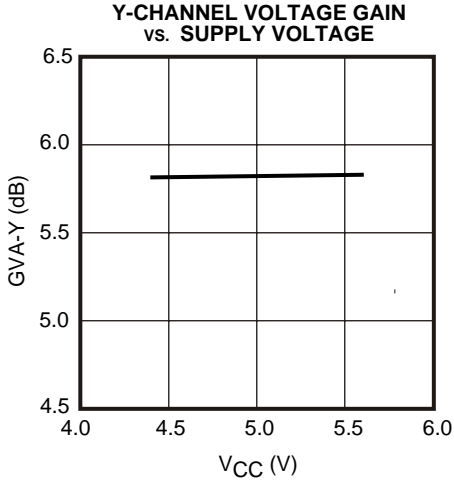

TYPICAL PERFORMANCE CHARACTERISTICS

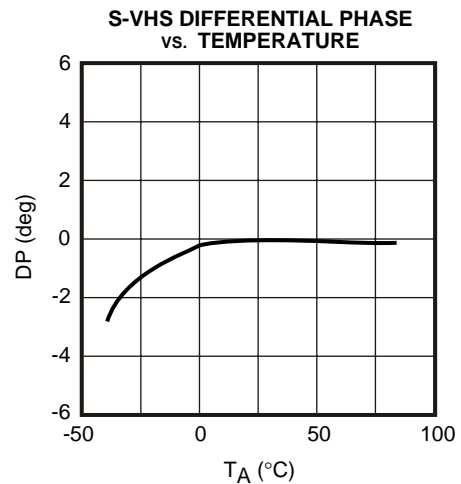
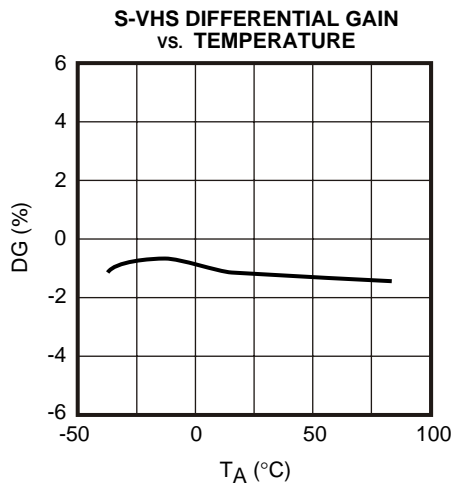
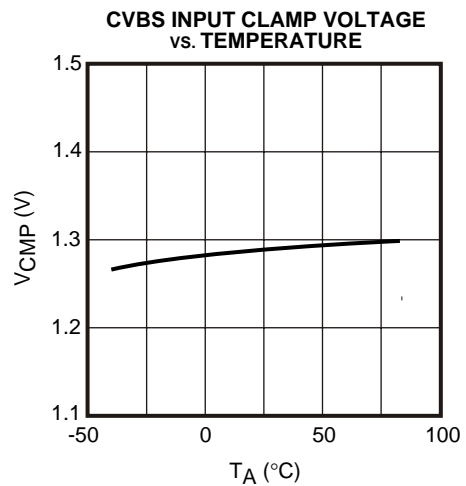
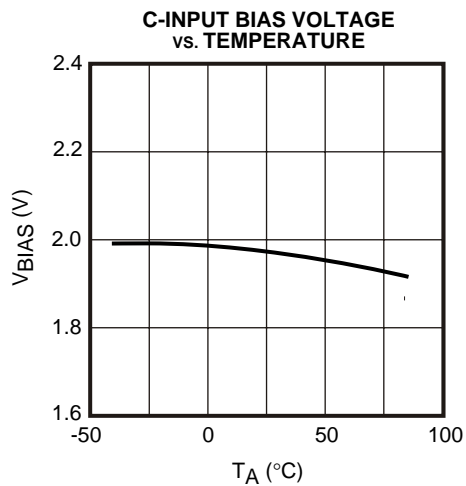
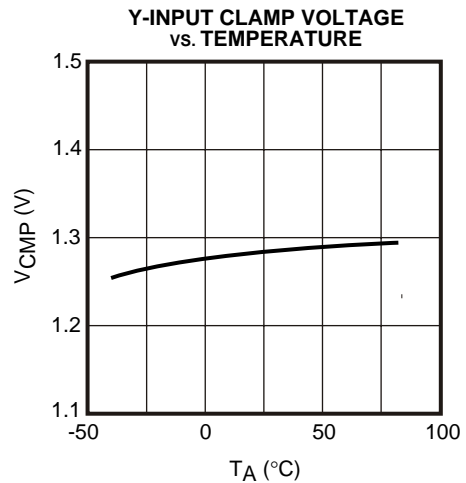
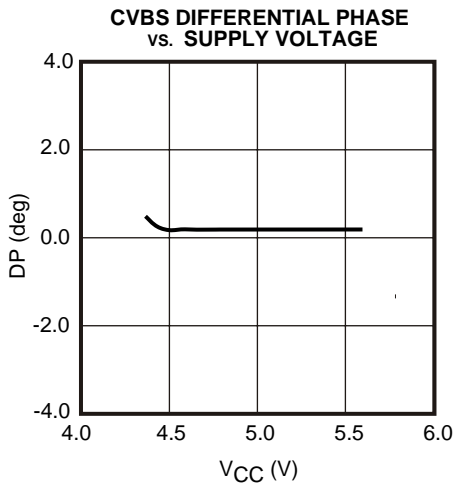

TYPICAL PERFORMANCE CHARACTERISTICS

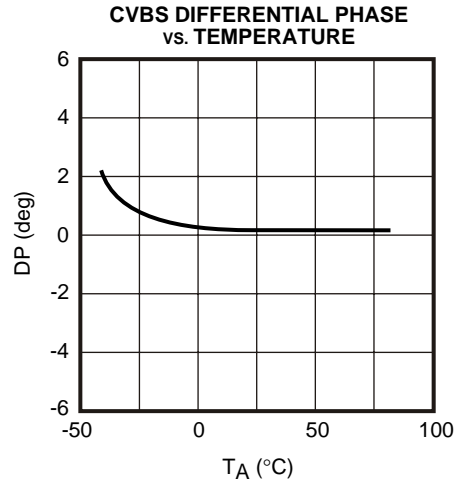
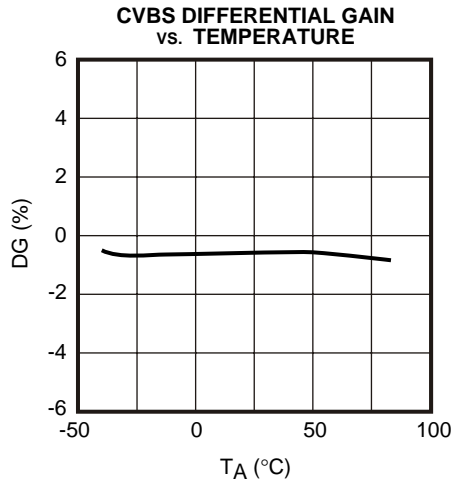

PIN FUNCTION DESCRIPTION

PIN NO.	SYMBOL	INTERNAL EQUIVALENT CIRCUIT	DESCRIPTION
1	Y-INPUT		Luminance Input Terminal. The luminance input signal is clamped at 1.25 V.
2	CVBS-INPUT		CVBS Signal Input Terminal. The CVBS input signal is clamped at 1.25 V.

PIN FUNCTION DESCRIPTION

PIN NO.	SYMBOL	INTERNAL EQUIVALENT CIRCUIT	DESCRIPTION
3 4	SAG OUTPUT		<p>Pin 3: SAG Terminal.</p> <p>Pin 4: Signal Output Terminal. The output is available to drive a $75\ \Omega + 75\ \Omega$ load.</p>
5	CHANGE SW		<p>Change-Over Switch Terminal for selecting S-VHS or CVBS. The S-VHS signal is applied to the output when Pin 5 is connected to High or Open. The CVBS signal is applied to the output when Pin 5 is connected to Low.</p>
6	GND		GND Terminal
7	V_{CC}		Power Supply Terminal
8	C-INPUT		<p>Chrominance Input Terminal. The chrominance input signal is biased to 2.0 V by a $100\ k\Omega$ bias resistor.</p>

PACKAGE OUTLINE

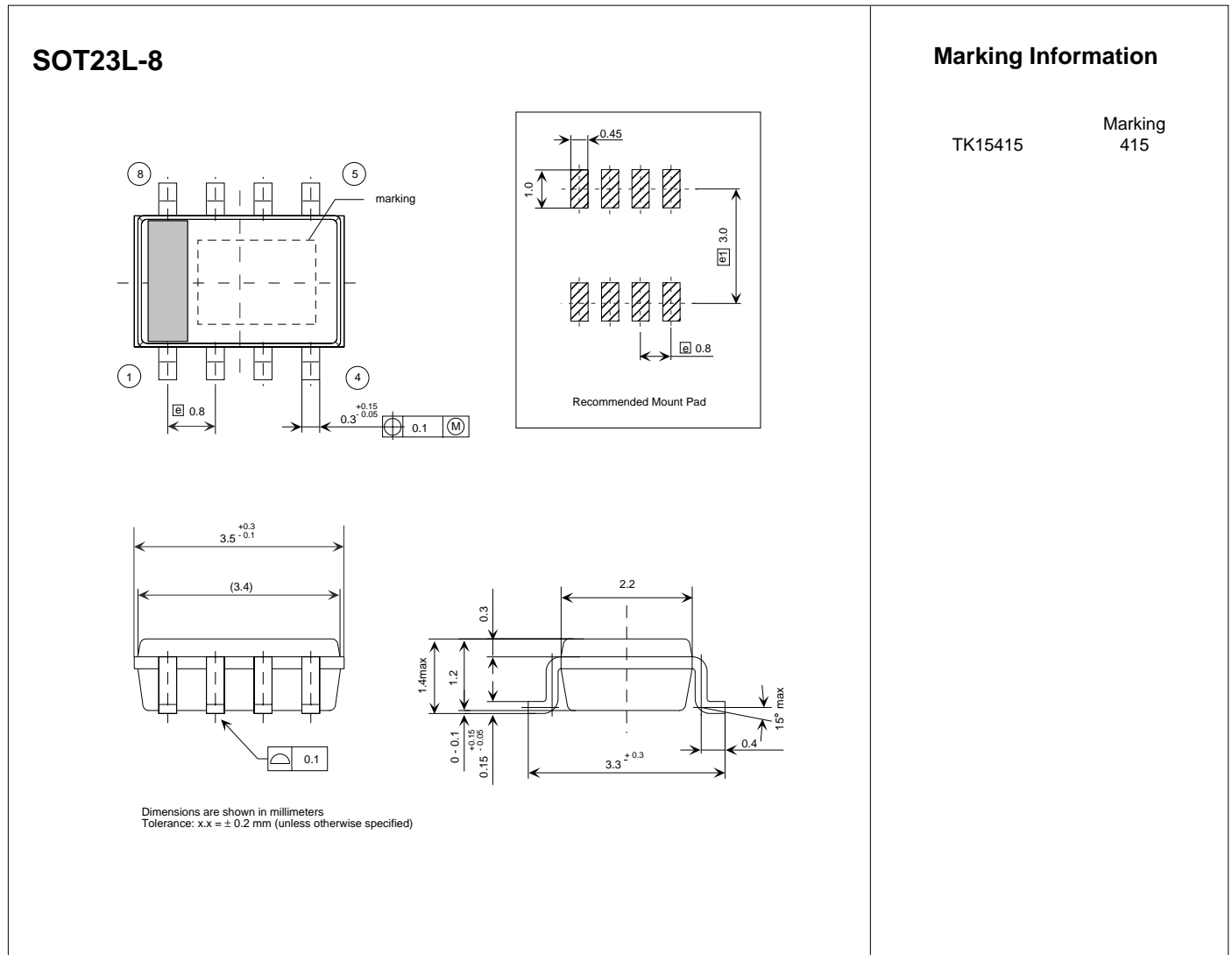

Toko America, Inc. Headquarters
1250 Feehanville Drive, Mount Prospect, Illinois 60056
Tel: (847) 297-0070 Fax: (847) 699-7864

TOKO AMERICA REGIONAL OFFICES

Midwest Regional Office
Toko America, Inc.
1250 Feehanville Drive
Mount Prospect, IL 60056
Tel: (847) 297-0070
Fax: (847) 699-7864

Western Regional Office
Toko America, Inc.
2480 North First Street, Suite 260
San Jose, CA 95131
Tel: (408) 432-8281
Fax: (408) 943-9790

Eastern Regional Office
Toko America, Inc.
107 Mill Plain Road
Danbury, CT 06811
Tel: (203) 748-6871
Fax: (203) 797-1223

Semiconductor Technical Support
Toko Design Center
4755 Forge Road
Colorado Springs, CO 80907
Tel: (719) 528-2200
Fax: (719) 528-2375

Visit our Internet site at <http://www.tokoam.com>

The information furnished by TOKO, Inc. is believed to be accurate and reliable. However, TOKO reserves the right to make changes or improvements in the design, specification or manufacture of its products without further notice. TOKO does not assume any liability arising from the application or use of any product or circuit described herein, nor for any infringements of patents or other rights of third parties which may result from the use of its products. No license is granted by implication or otherwise under any patent or patent rights of TOKO, Inc.