

1.03 V REGULATOR WITH ON/OFF SWITCH

FEATURES

- Low Input Voltage Operation (Single Battery Cell)
- Internal PNP Transistor
- Built-In Shutdown Control (Off Current, 8 μ A Typ)
- Low Dropout Voltage (30 mV Typ)
- Very Small Surface Mount Package (SOT-25)

APPLICATIONS

- Pagers
- Personal Communication Equipment
- Portable Consumer Equipment
- Radio Control Systems
- Single Battery Cell Systems

DESCRIPTION

The TK702xx is a very low dropout, low input voltage operation regulator suitable for single battery cell applications. This regulator provides 1.03 V output with a dropout voltage of only 30 mV. The active high control provides on/off switching of the output. In the off mode, the standby supply current is 8 μ A, thus extending battery life.

The TK702xx is available in a very small plastic surface mount package (SOT-25).

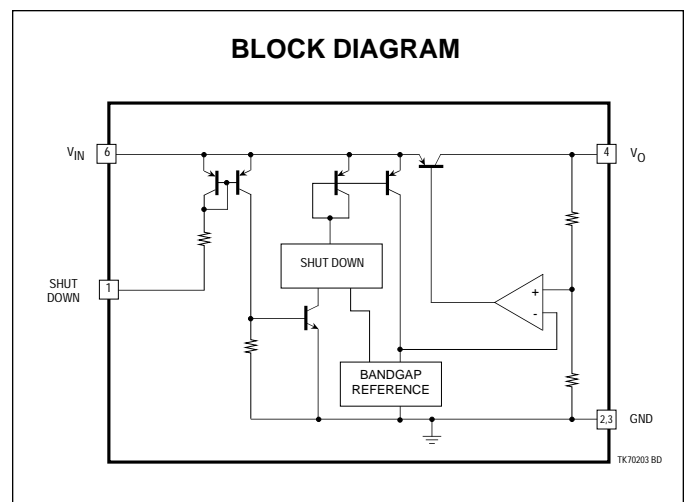
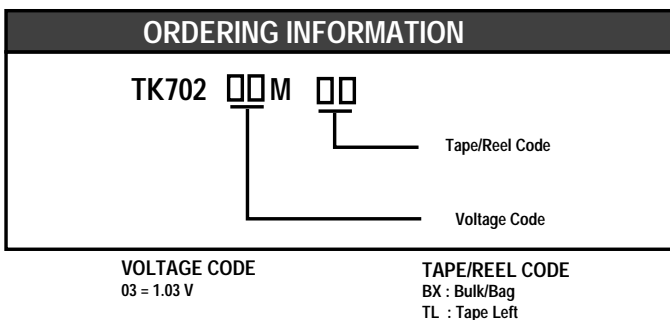
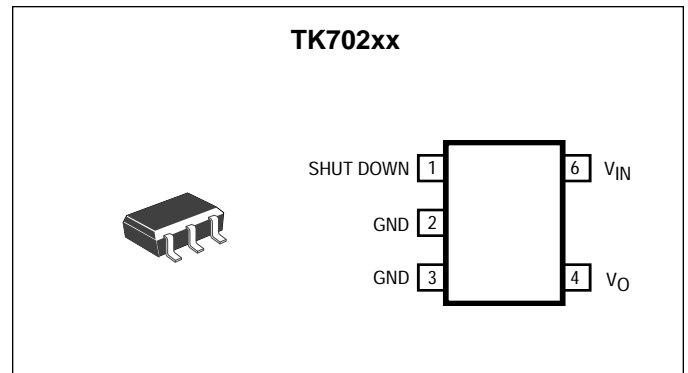

ABSOLUTE MAXIMUM RATINGS

Input Voltage	6 V	Storage Temperature Range	-55 to +150 °C
Power Dissipation	150 mW	Operating Temperature Range	-10 to +60 °C
Operating Voltage Range	0.9 to 5.0 V	Lead Soldering Temp. (10 sec.)	240 °C
Junction Temperature	150 °C		

ELECTRICAL CHARACTERISTICS

Test Conditions: $V_{CC} = 1.4 \text{ V}$, $T_A = 25 \text{ °C}$, unless otherwise specified.

SYMBOL	PARAMETER	TEST CONDITIONS	MIN	TYP	MAX	UNITS
I_{IN}	Supply Current	$I_O = 0 \text{ mA}$		180	280	μA
		$V_{IN} = V_{OUT} - 50 \text{ mV}$, $I_O = 0 \text{ mA}$		400	800	μA
I_{STBY}	Standby Current	$V_{OUT} = \text{Off}$, $R = 820 \text{ k}\Omega$, Note 1		8	13	μA
V_O	Output Voltage	$I_O = 2 \text{ mA}$	0.98	1.03	1.065	V
V_{DROP}	In/Out Voltage Drop	$I_O = 2 \text{ mA}$		30	60	mV
I_O	Output Current	Note 2	8	16		mA
Line Reg	Line Regulation	$V_{IN} = 1.4 \rightarrow 1.7 \text{ V}$		10	30	mV
Load Reg	Load Regulation	$I_O = 0.1 \rightarrow 5.0 \text{ mA}$, Note 3		5	20	mV
RR	Ripple Rejection	100 mVrms, $f = 400 \text{ Hz}$, $I_O = 2 \text{ mA}$		36		dB
$\Delta V_O / \Delta T_A$	Output Voltage Temperature Dependency	$I_O = 2 \text{ mA}$, $T_A = -10 \text{ to } +50 \text{ °C}$		0.3		mV/°C
Control Terminal Specification		$R = 820 \text{ k}\Omega$ (series connection)				
I_{CONT}	Control Current	$V_{OUT} = \text{Off}$, $V_{CONT} = V_{CC} - 1.4 \text{ V}$		2		μA
V_{CONT}	Control Voltage	$V_{OUT} = \text{On}$, $T_A = -10 \text{ to } +60 \text{ °C}$	$V_{CC} - 0.2$		V_{CC}	V
		$V_{OUT} = \text{Off}$, $T_A = -10 \text{ to } +60 \text{ °C}$	0		$V_{CC} - 0.8$	V

Note 1: Standby current (including control current) is the input current with a 820k Ω connected in series with the control terminal.

Note 2: I_O (Load Current) is a output current value when V_O drops down 0.2 V from V_O at $I_O = 2 \text{ mA}$.

Note 3: Since the measurement (pulse measurement) is in a constant T_J , the output change due to temperature change is not included.

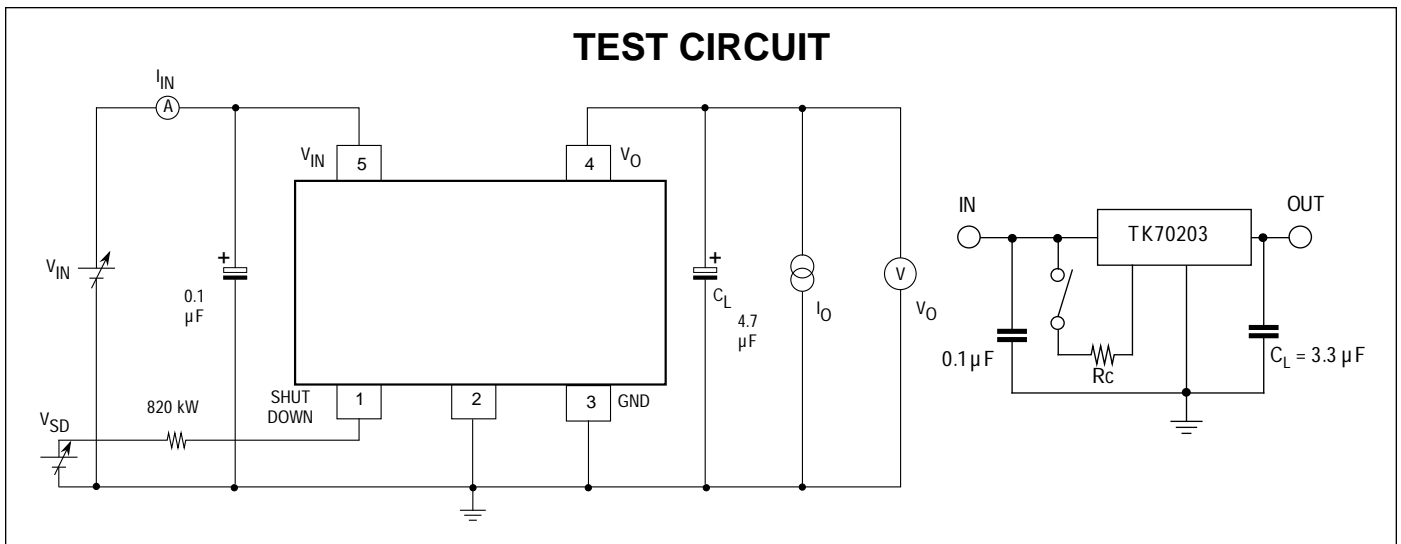

TYPICAL PERFORMANCE CHARACTERISTICS

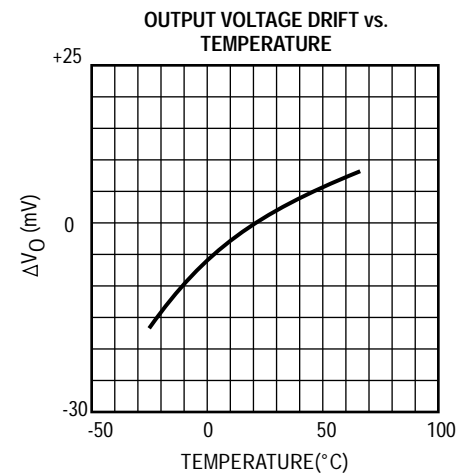
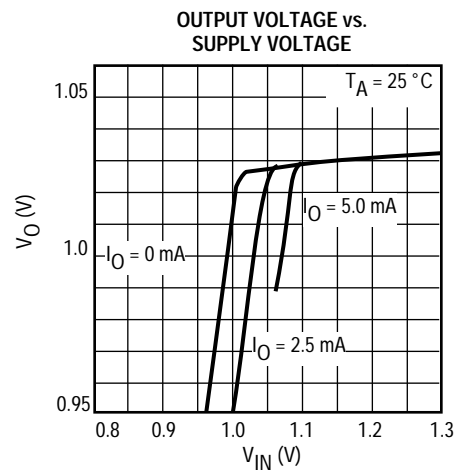
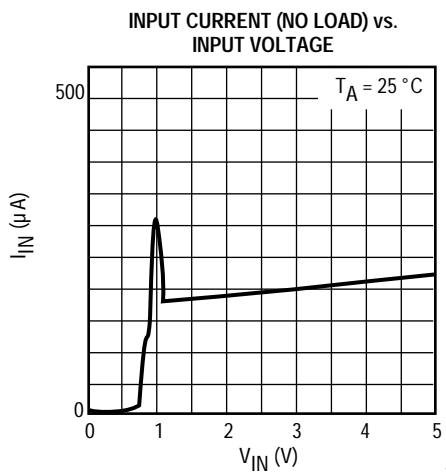
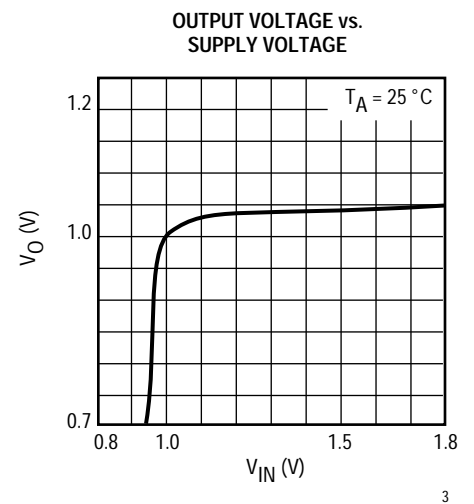
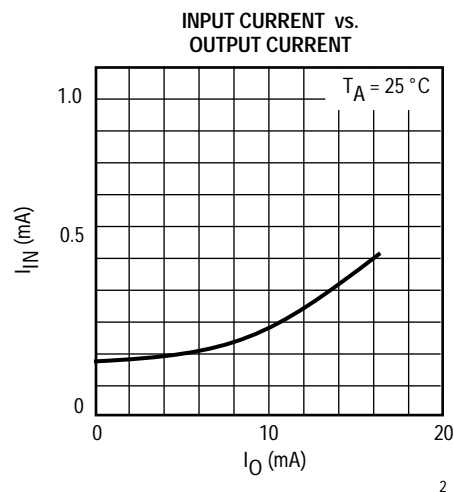
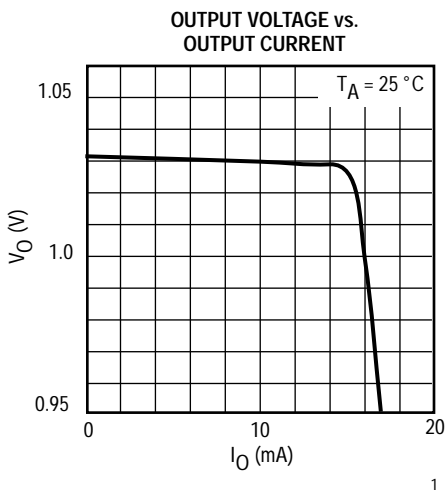

TYPICAL PERFORMANCE CHARACTERISTICS

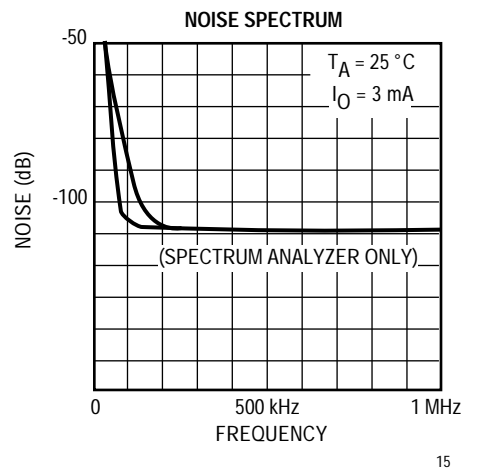
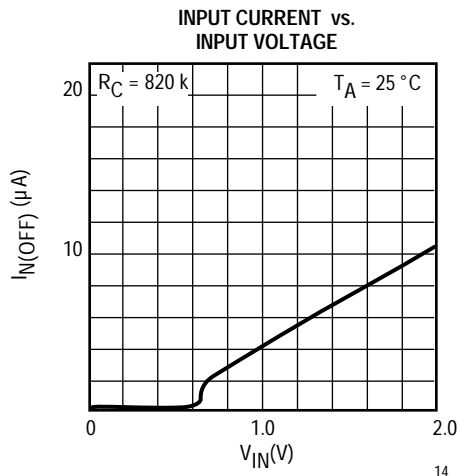
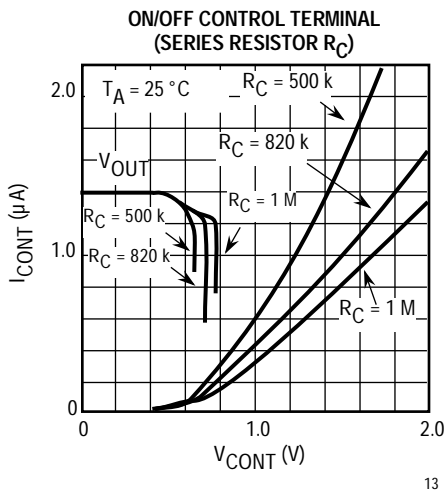
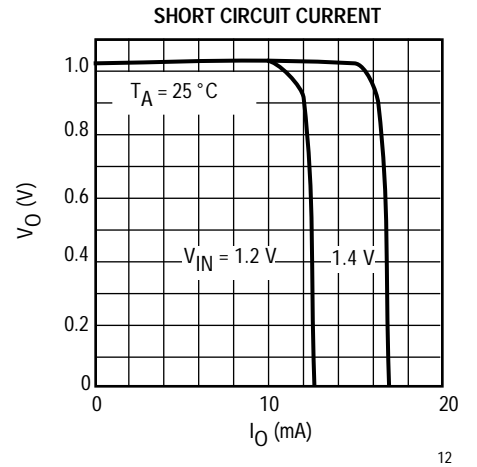
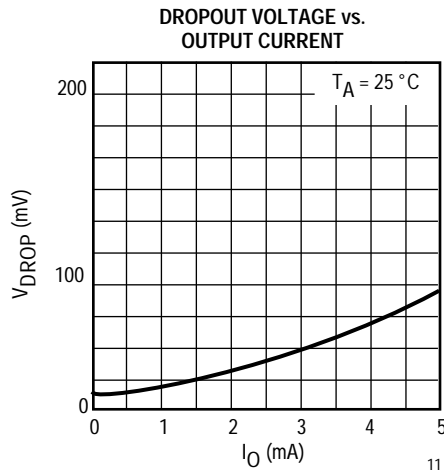
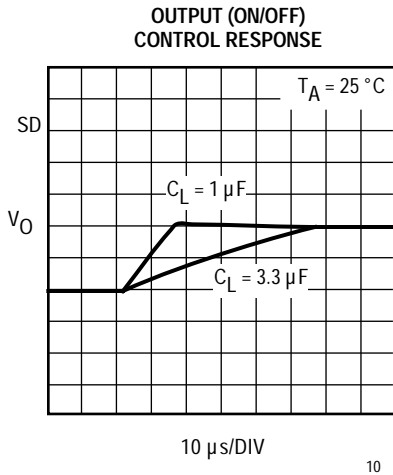
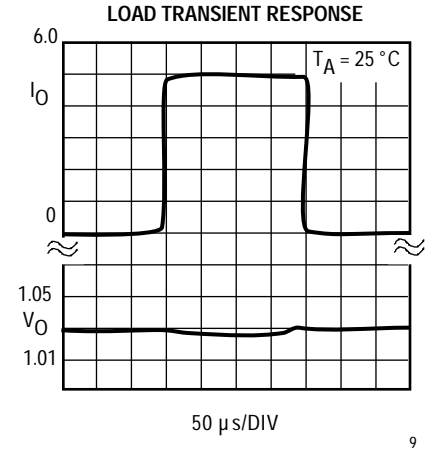
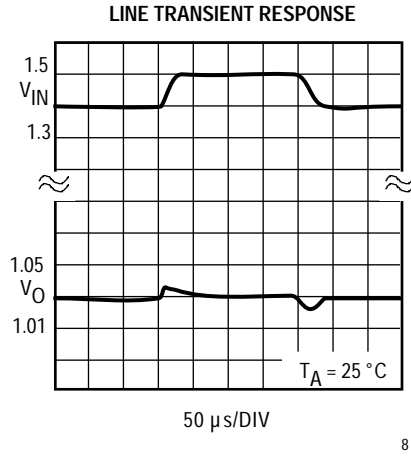
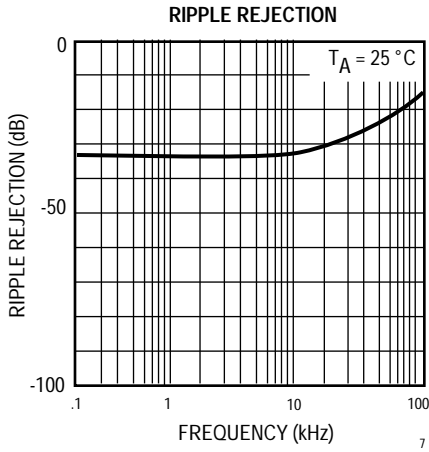

APPLICATION NOTES

RECOMMENDED MOUNTING

Optimum performance can only be achieved when the IC is mounted on a PC board according to the diagram below. This is because of the extremely small package and limited power dissipation. Shape the metal portion of the PCB as shown in the following drawing.

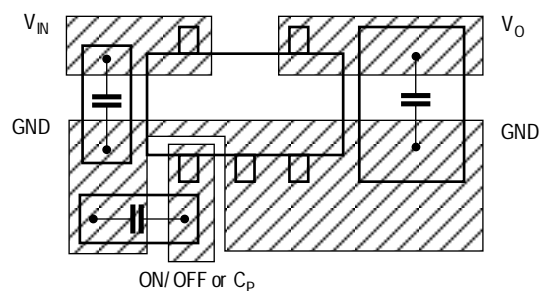

TK70203•FIG1A

Use a large bypass capacitor and connect it in a place near GND of the IC. Pay attention to temperature characteristics of the capacitor, especially the increase of ESR and decrease of capacitance in low temperatures. Oscillation, reduction of ripple rejection and increased noise may occur in some cases if the proper capacitor is not used. An output capacitor more than $1.0\ \mu\text{F}$ is required to maintain stability. The standard test condition is $3.3\ \mu\text{F}$ ($T_A = 25\ ^\circ\text{C}$).

DROPOUT VOLTAGE

Dropout voltage is the voltage difference between the input voltage and the output voltage where the output voltage decreases to 100 mV below the nominal output voltage as the input voltage is decreased.

To measure dropout voltage, set the input voltage to the nominal output voltage +1 V and measure the output voltage. Reduce the input voltage to the point where the output is 100 mV below the previously measured value. The dropout voltage is the difference between the input and output voltage at this point. This voltage depends on the load current and ambient temperature.

PACKAGE OUTLINE

SOT-25

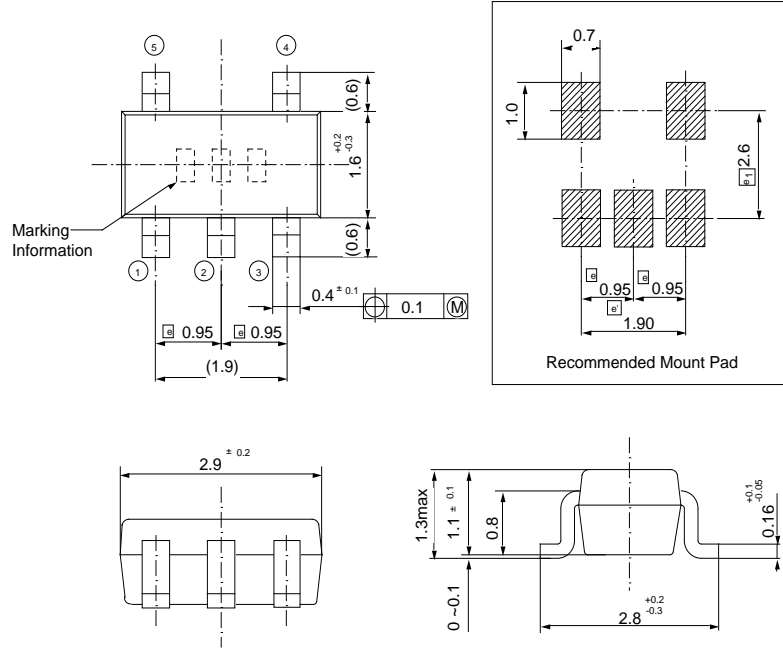

Unit:mm

Marking Information

TK70203 L03

The information furnished by TOKO, Inc. is believed to be accurate and reliable. However, TOKO reserves the right to make changes or improvements in the design, specification or manufacture of its products without further notice. TOKO does not assume any liability arising from the application or use of any product or circuit described herein, nor for any infringements of patents or other rights of third parties which may result from the use of its products. No license is granted by implication or otherwise under any patent or patent rights of TOKO, Inc.



YOUR LOCAL REPRESENTATIVE IS:

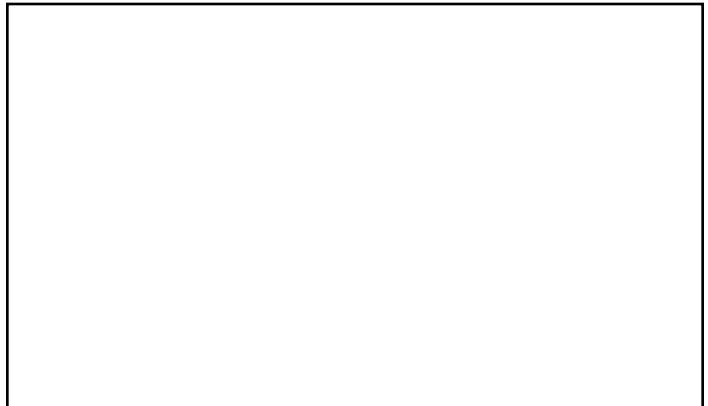

TOKO America, Inc.
1250 Feehanville Dr.
Mt. Prospect, IL 60056

Tel: 1(800) PIK-TOKO
Fax: 1(847) 699-1194