

TL431/TL431A

Programmable Shunt Regulator

Features

- Programmable Output Voltage to 36 Volts
- Low Dynamic Output Impedance 0.2Ω Typical
- Sink Current Capability of 1.0 to 100mA
- Equivalent Full-Range Temperature Coefficient of 50ppm/°C Typical
- Temperature Compensated For Operation Over Full Rated Operating Temperature Range
- Low Output Noise Voltage
- Fast Turn-on Response

Description

The TL431/TL431A are three-terminal adjustable regulator series with a guaranteed thermal stability over applicable temperature ranges. The output voltage may be set to any value between VREF (approximately 2.5 volts) and 36 volts with two external resistors. These devices have a typical dynamic output impedance of 0.2Ω. Active output circuitry provides a very sharp turn-on characteristic, making these devices excel as replacement for zener diodes in many applications.

TO-92



1. Ref 2. Anode 3. Cathode

8-DIP



1. Cathode 2.3.4.5.7. NC
6. Anode 8. Ref

8-SOP



1. Cathode 2. 3. 6. 7. Anode
8. Ref 4. 5. NC

Internal Block Diagram

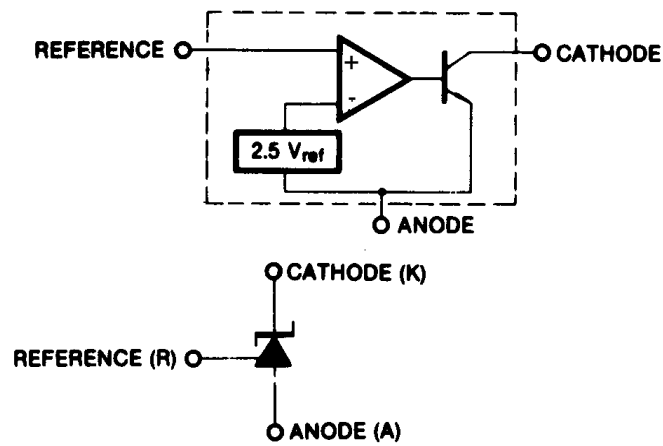

Absolute Maximum Ratings

(Operating temperature range applies unless otherwise specified.)

Parameter	Symbol	Value	Unit
Cathode Voltage	V _{KA}	37	V
Cathode Current Range (Continuous)	I _{KA}	-100 ~ +150	mA
Reference Input Current Range	I _{REF}	-0.05 ~ +10	mA
Power Dissipation D, LP Suffix Package	PD	770	mW
P Suffix Package		1000	mW
Operating Temperature Range	T _{OPR}	-25 ~ +85	°C
Junction Temperature	T _J	150	°C
Storage Temperature Range	T _{STG}	-65 ~ +150	°C

Recommended Operating Conditions

Parameter	Symbol	Min	Typ	Max	Unit
Cathode Voltage	V _{KA}	V _{REF}	-	36	V
Cathode Current	I _{KA}	1.0	-	100	mA

Electrical Characteristics

($T_A = +25^\circ\text{C}$, unless otherwise specified)

Parameter	Symbol	Conditions	TL431			TL431A			Unit	
			Min.	Typ.	Max.	Min.	Typ.	Max.		
Reference Input Voltage	V_{REF}	$V_{KA}=V_{REF}, I_{KA}=10\text{mA}$	2.440	2.495	2.550	2.470	2.495	2.520	V	
Deviation of Reference Input Voltage Over-Temperature (Note 1)	$\Delta V_{REF}/\Delta T$	$V_{KA}=V_{REF}, I_{KA}=10\text{mA}$ $T_{MIN} \leq T_A \leq T_{MAX}$	-	4.5	17	-	4.5	17	mV	
Ratio of Change in Reference Input Voltage to the Change in Cathode Voltage	$\Delta V_{REF}/\Delta V_{KA}$	$I_{KA}=10\text{mA}$	$\Delta V_{KA}=10\text{V}-V_{REF}$	-	-1.0	-2.7	-	-1.0	-2.7	mV/V
			$\Delta V_{KA}=36\text{V}-10\text{V}$	-	-0.5	-2.0	-	-0.5	-2.0	
Reference Input Current	I_{REF}	$I_{KA}=10\text{mA}, R_1=10\text{K}\Omega, R_2=\infty$	-	1.5	4	-	1.5	4	μA	
Deviation of Reference Input Current Over Full Temperature Range	$\Delta I_{REF}/\Delta T$	$I_{KA}=10\text{mA}, R_1=10\text{K}\Omega, R_2=\infty$ $T_A = \text{Full Range}$	-	0.4	1.2	-	0.4	1.2	μA	
Minimum Cathode Current for Regulation	$I_{KA(MIN)}$	$V_{KA}=V_{REF}$	-	0.45	1.0	-	0.45	1.0	mA	
Off - Stage Cathode Current	$I_{KA(OFF)}$	$V_{KA}=36\text{V}, V_{REF}=0$	-	0.05	1.0	-	0.05	1.0	μA	
Dynamic Impedance (Note 2)	Z_{KA}	$V_{KA}=V_{REF}, I_{KA}=1 \text{ to } 100\text{mA}$ $f \geq 1.0\text{KHz}$	-	0.15	0.5	-	0.15	0.5	Ω	

- $T_{MIN} = -25^\circ\text{C}, T_{MAX} = +85^\circ\text{C}$

Test Circuits

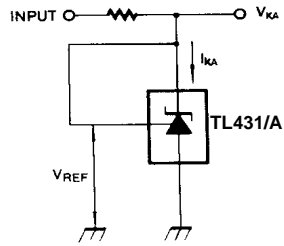

Figure 1. Test Circuit for $V_{KA} = V_{REF}$

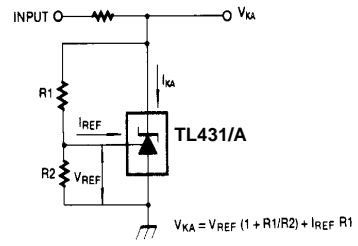

Figure 2. Test Circuit for $V_{KA} \geq V_{REF}$

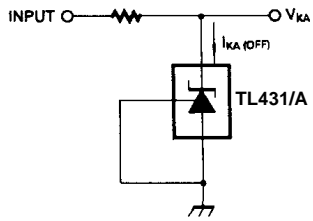

Figure 3. Test Circuit for $I_{KA(OFF)}$

Typical Performance Characteristics

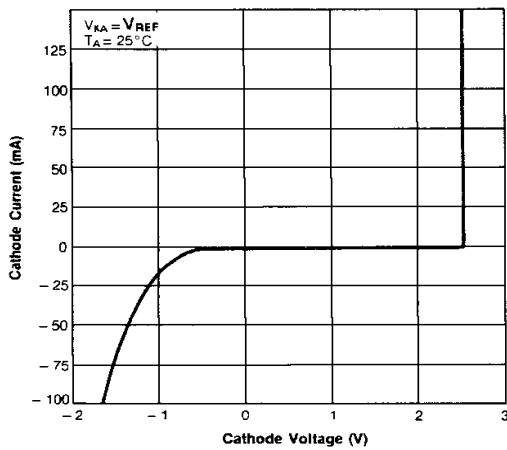

Figure 1. Cathode Current vs. Cathode Voltage

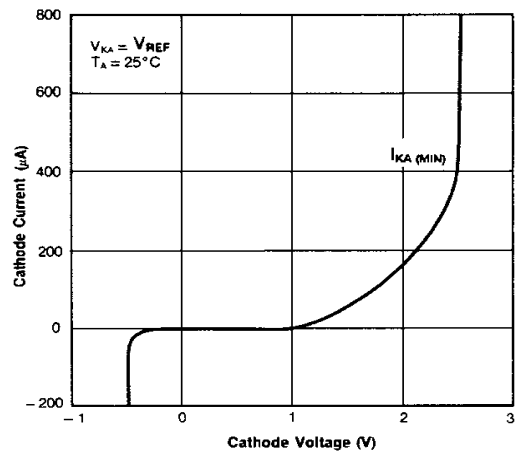

Figure 2. Cathode Current vs. Cathode Voltage

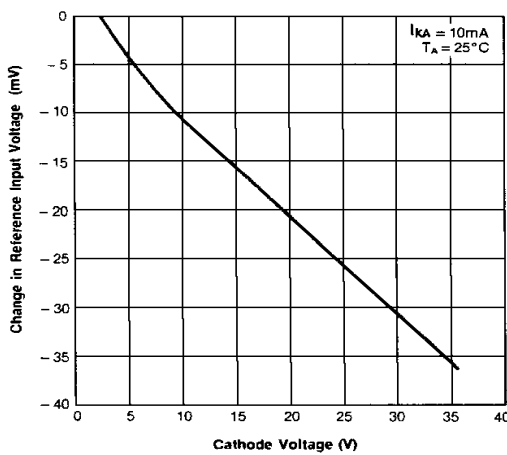

Figure 3. Change In Reference Input Voltage vs. Cathode Voltage

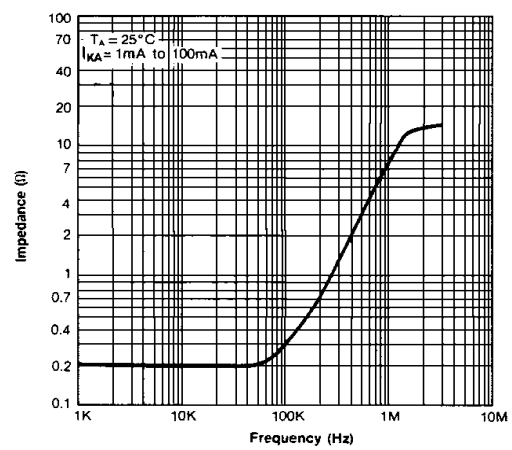

Figure 4. Dynamic Impedance Frequency

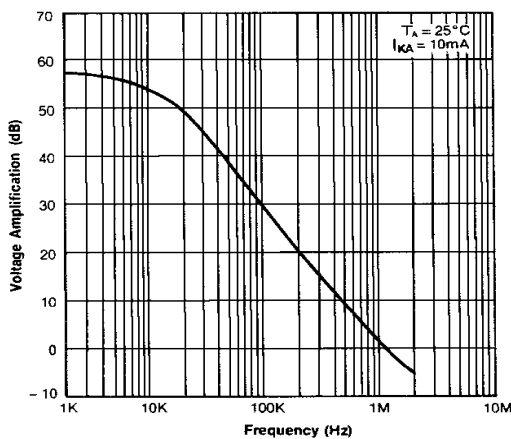

Figure 5. Small Signal Voltage Amplification vs. Frequency

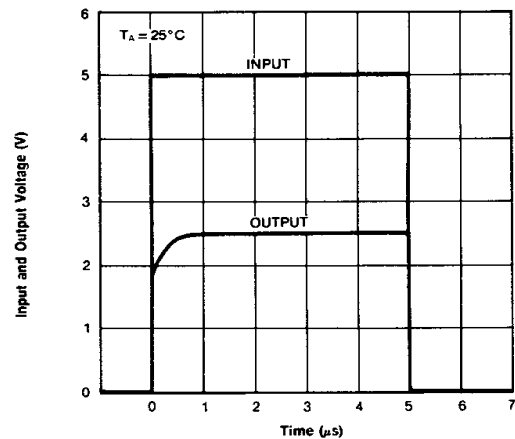

Figure 6. Pulse Response

Typical Application

$$V_O = \left(1 + \frac{R_1}{R_2}\right) V_{ref}$$

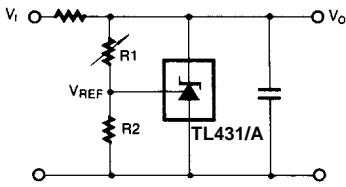

Figure 10. Shunt Regulator

$$V_O = V_{ref} \left(1 + \frac{R_1}{R_2}\right)$$

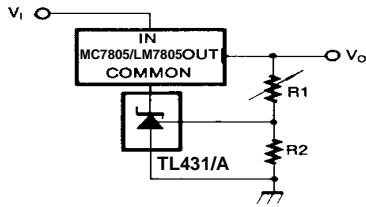

Figure 11. Output Control for Three-Terminal Fixed Regulator

$$V_O = \left(1 + \frac{R_1}{R_2}\right) V_{ref}$$

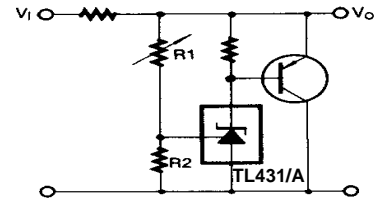

Figure 12. High Current Shunt Regulator

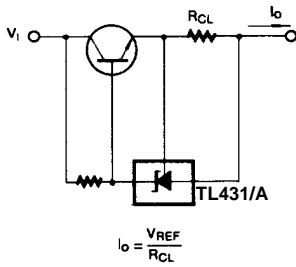

Figure 13. Current Limit or Current Source

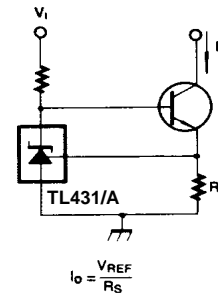
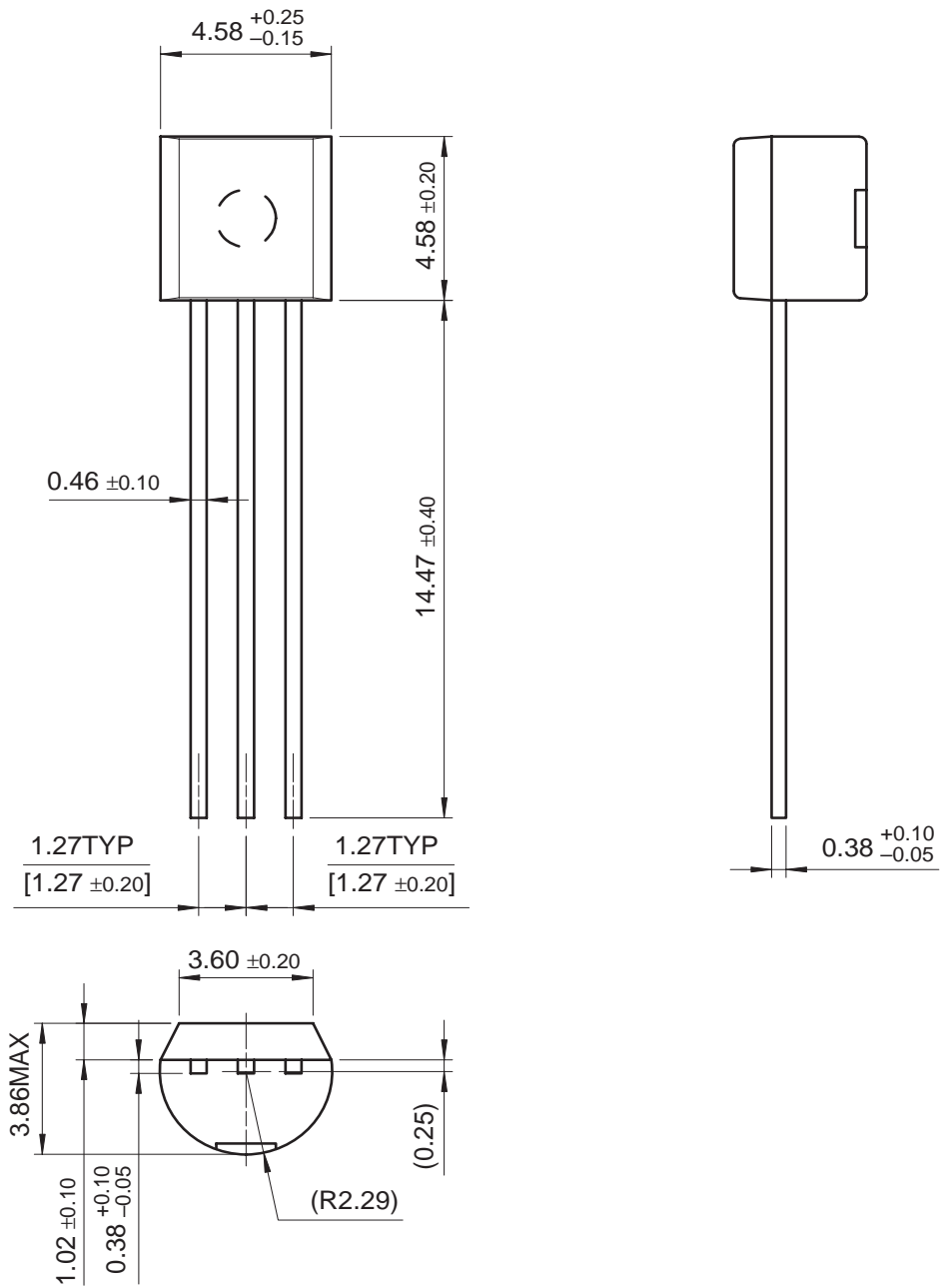

Figure 14. Constant-Current Sink

Mechanical Dimensions

Package

TO-92



Mechanical Dimensions (Continued)

Package

8-DIP

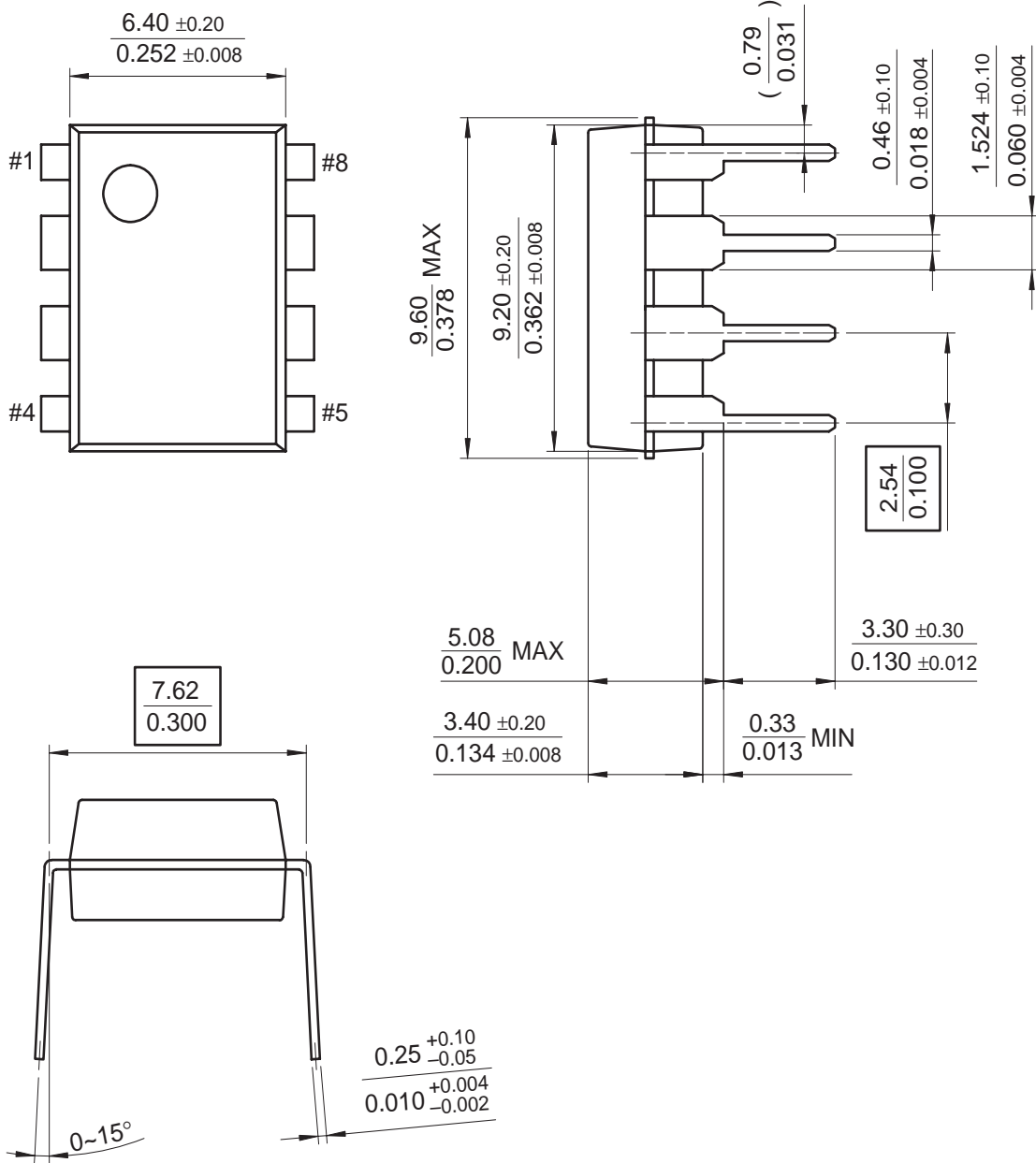

Mechanical Dimensions (Continued)

Package

8-SOP

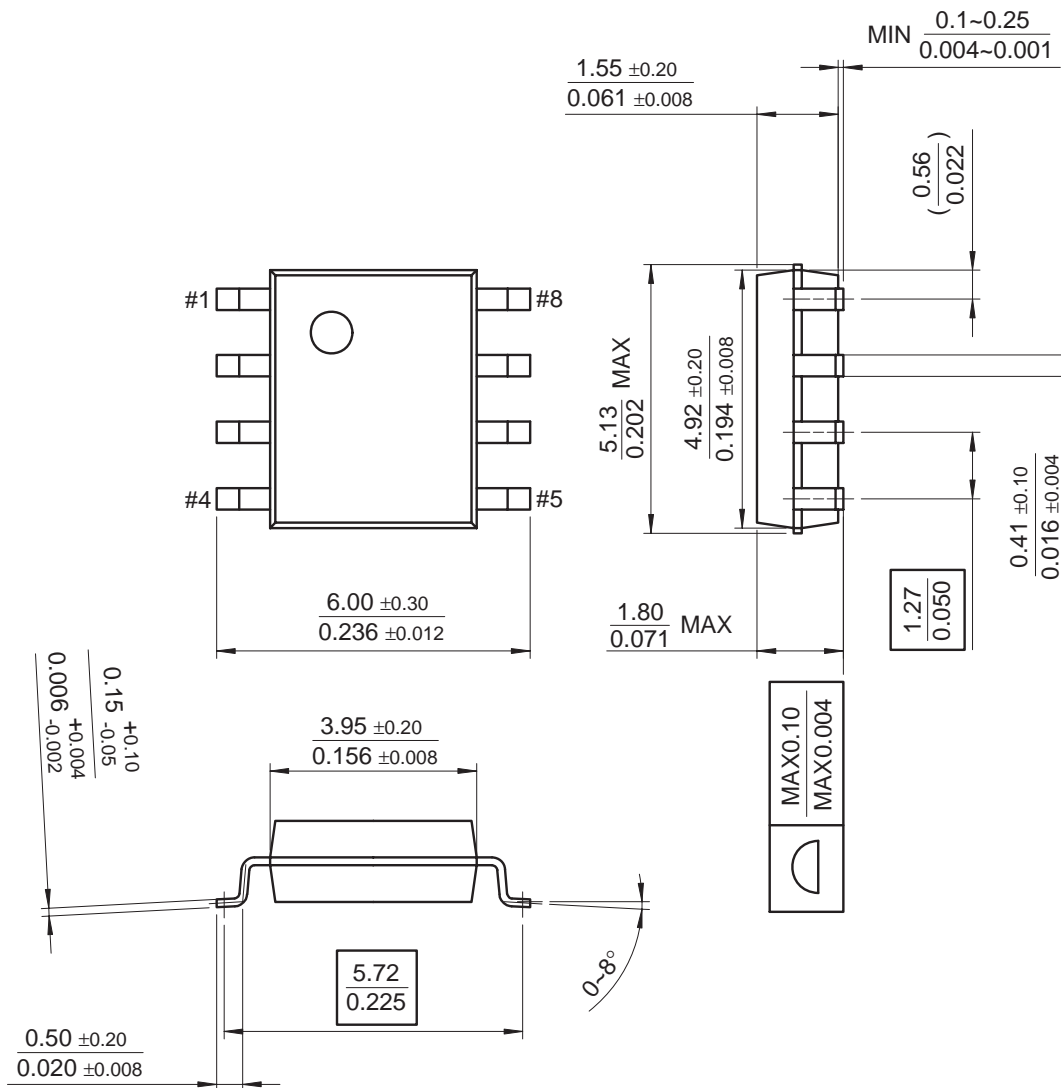

Ordering Information

Product Number	Output Voltage Tolerance	Package	Operating Temperature
TL431ACLP	1%	TO-92	-25 ~ + 85°C
TL431ACD		8-SOP	
TL431CLP	2%	TO-92	
TL431CP		8-DIP	
TL431CD		8-SOP	

DISCLAIMER

FAIRCHILD SEMICONDUCTOR RESERVES THE RIGHT TO MAKE CHANGES WITHOUT FURTHER NOTICE TO ANY PRODUCTS HEREIN TO IMPROVE RELIABILITY, FUNCTION OR DESIGN. FAIRCHILD DOES NOT ASSUME ANY LIABILITY ARISING OUT OF THE APPLICATION OR USE OF ANY PRODUCT OR CIRCUIT DESCRIBED HEREIN; NEITHER DOES IT CONVEY ANY LICENSE UNDER ITS PATENT RIGHTS, NOR THE RIGHTS OF OTHERS.

LIFE SUPPORT POLICY

FAIRCHILD'S PRODUCTS ARE NOT AUTHORIZED FOR USE AS CRITICAL COMPONENTS IN LIFE SUPPORT DEVICES OR SYSTEMS WITHOUT THE EXPRESS WRITTEN APPROVAL OF THE PRESIDENT OF FAIRCHILD SEMICONDUCTOR CORPORATION. As used herein:

1. Life support devices or systems are devices or systems which, (a) are intended for surgical implant into the body, or (b) support or sustain life, and (c) whose failure to perform when properly used in accordance with instructions for use provided in the labeling, can be reasonably expected to result in a significant injury of the user.
2. A critical component in any component of a life support device or system whose failure to perform can be reasonably expected to cause the failure of the life support device or system, or to affect its safety or effectiveness.