

TOSHIBA Photocoupler GaAs Ired & Photo-Transistor

TLP629, TLP629-2, TLP629-4

Telecommunication
Office Machine
Telephone Use Equipment

The TOSHIBA TLP629, -2, and -4 consists of a photo-transistor optically coupled to a gallium arsenide infrared emitting diode. The TLP629-2 offers two isolated channels in an eight lead plastic DIP, while the TLP629-4 provides four isolated channels in a sixteen plastic DIP. This is suitable for application of DC input current up to 150mA.

- IF maximum rating: 150mA
- Collector-emitter voltage: 55V (min.)
- Current transfer ratio: 25% (min.) (IF=20mA)
- Isolation voltage: 5000V_{rms} (min.)
- UL recognized: UL1577, file no. E67349
- BSI approved: BS EN60065:2002, certificate no.7426
BS EN60950-1:2002, certificate no.7427

Pin Configurations (top view)

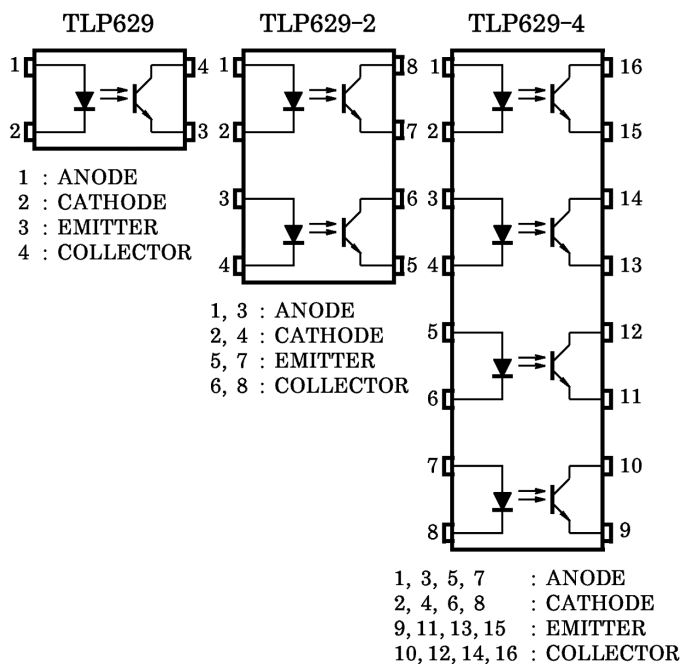

Unit in mm

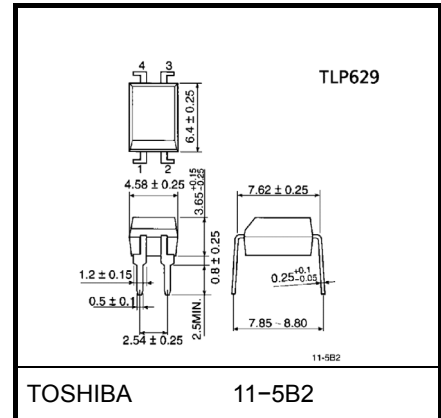

Weight: 0.26 g

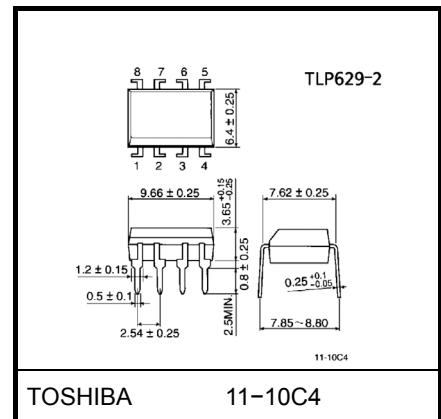

Weight: 0.54 g

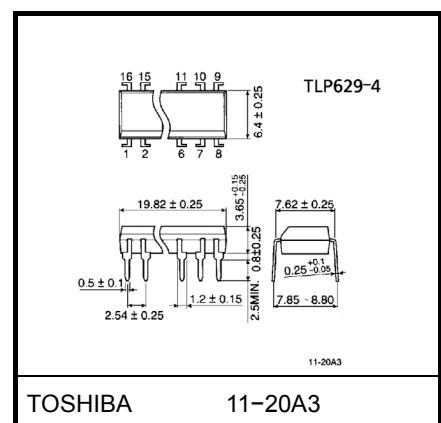

Weight: 1.1 g

Absolute Maximum Ratings (Ta = 25°C)

Characteristic		Symbol	Rating		Unit
			TLP629	TLP629-2,4	
LED	Forward current	I_F	150		mA
	Forward current derating	$\Delta I_F / ^\circ\text{C}$	-1.5 (Ta ≥ 25°C)		mA / °C
	Pulse forward current	I_{FP}	1 (100µs pulse, 100pps)		A
	Reverse voltage	V_R	5		V
	Junction temperature	T_j	125		°C
Detector	Collector-emitter voltage	V_{CEO}	55		V
	Emitter-collector voltage	V_{ECO}	7		V
	Collector current	I_C	80		mA
	Collector power dissipation (1 circuit)	P_C	150	100	mW
	Collector power dissipation derating (1 circuit, Ta ≥ 25°C)	$\Delta P_C / ^\circ\text{C}$	-1.5	-1.0	mW / °C
	Junction temperature	T_j	125		°C
Storage temperature range		T_{stg}	-55~125		°C
Operating temperature range		T_{opr}	-55~100		°C
Lead soldering temperature		T_{sol}	260 (10s)		°C
Total package power dissipation		P_T	250	200	mW
Total package power dissipation derating (Ta ≥ 25°C)		$\Delta P_T / ^\circ\text{C}$	-2.5	2.0	mW / °C
Isolation voltage (Note 1)		BV_S	5000 (AC, 1min., RH ≤ 60%)		V_{rms}

Note: Using continuously under heavy loads (e.g. the application of high temperature/current/voltage and the significant change in temperature, etc.) may cause this product to decrease in the reliability significantly even if the operating conditions (i.e. operating temperature/current/voltage, etc.) are within the absolute maximum ratings.

Please design the appropriate reliability upon reviewing the Toshiba Semiconductor Reliability Handbook ("Handling Precautions"/"Derating Concept and Methods") and individual reliability data (i.e. reliability test report and estimated failure rate, etc).

(Note 1) Device considered a two terminal: LED side pins shorted together, and detector side pins shorted together.

Recommended Operating Conditions

Characteristics	Symbol	Min.	Typ.	Max.	Unit
Supply voltage	V_{CC}	—	5	24	V
Forward current	I_F	—	20	120	mA
Collector current	I_C	—	1	10	mA
Operating temperature	T_{opr}	-25	—	85	°C

Note: Recommended operating conditions are given as a design guideline to obtain expected performance of the device. Additionally, each item is an independent guideline respectively. In developing designs using this product, please confirm specified characteristics shown in this document.

Individual Electrical Characteristics (Ta = 25°C)

Characteristic		Symbol	Test Condition	Min.	Typ.	Max.	Unit
LED	Forward voltage	V_F	$I_F = 100 \text{ mA}$	—	1.4	1.7	V
	Forward current	I_F	$V_F = 0.7 \text{ V}$	—	2.5	20	μA
	Reverse current	I_R	$V_R = 5 \text{ V}$	—	—	10	μA
	Capacitance	C_T	$V = 0, f = 1 \text{ MHz}$	—	50	—	pF
Detector	Collector-emitter breakdown voltage	$V_{(BR)CEO}$	$I_C = 0.5 \text{ mA}$	55	—	—	V
	Emitter-collector breakdown voltage	$V_{(BR)ECO}$	$I_E = 0.1 \text{ mA}$	7	—	—	V
	Collector dark current	I_{CEO}	$V_{CE} = 24 \text{ V}$	—	10	100	nA
			$V_{CE} = 24 \text{ V}, T_a = 85^\circ\text{C}$	—	2	50	μA
Capacitance collector to emitter	C_{CE}	$V = 0, f = 1 \text{ MHz}$	—	10	—	pF	

Coupled Electrical Characteristics (Ta = 25°C)

Characteristic	Symbol	Test Condition	Min.	Typ.	Max.	Unit
Current transfer ratio	I_C / I_F	$I_F = 20 \text{ mA}, V_{CE} = 1 \text{ V}$	25	—	—	%
	I_C / I_F (high)	$I_F = 100 \text{ mA}, V_{CE} = 1 \text{ V}$	20	—	80	
Collector-emitter saturation voltage	$V_{CE(sat)}$	$I_C = 2.4 \text{ mA}, I_F = 20 \text{ mA}$	—	—	0.4	V
		$I_C = 2.4 \text{ mA}, I_F = 100 \text{ mA}$	—	—	0.4	
Off-state collector current	$I_{C(off)}$	$V_F = 0.7 \text{ V}, V_{CEO} = 24 \text{ V}$	—	1	1.0	μA

Isolation Characteristics (Ta = 25°C)

Characteristic	Symbol	Test Condition	Min.	Typ.	Max.	Unit
Capacitance input to output	C_S	$V_S = 0, f = 1 \text{ MHz}$	—	0.8	—	pF
Isolation resistance	R_S	$V_S = 500 \text{ V}$	5×10^{10}	10^{14}	—	Ω
Isolation voltage	BV_S	AC, 1 minute	5000	—	—	V_{rms}
		AC, 1 second, in oil	—	10000	—	
		DC, 1 minute, in oil	—	10000	—	Vdc

Switching Characteristics (Ta = 25°C)

Characteristic	Symbol	Test Condition	Min.	Typ.	Max.	Unit
Rise time	t_r	$V_{CC} = 10\text{ V}, I_C = 2\text{ mA}$ $R_L = 100\Omega$	—	2	—	μs
Fall time	t_f		—	3	—	
Turn-on time	t_{on}		—	3	10	
Turn-off time	t_{off}		—	3	10	
Turn-on time	t_{ON}	$R_L = 1.9\text{ k}\Omega$ $V_{CC} = 5\text{ V}, I_F = 16\text{ mA}$ (Fig.1)	—	2	—	μs
Storage time	t_s		—	15	—	
Turn-off time	t_{OFF}		—	25	—	

Fig. 1 Switching time test circuit

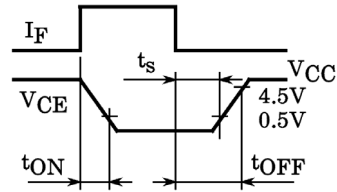
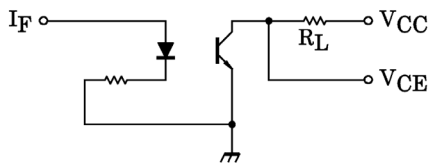

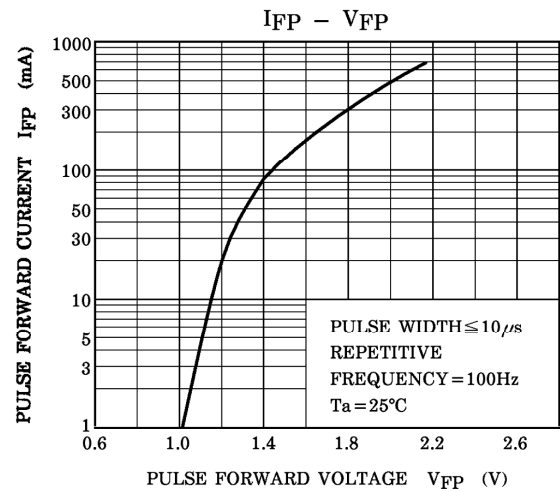
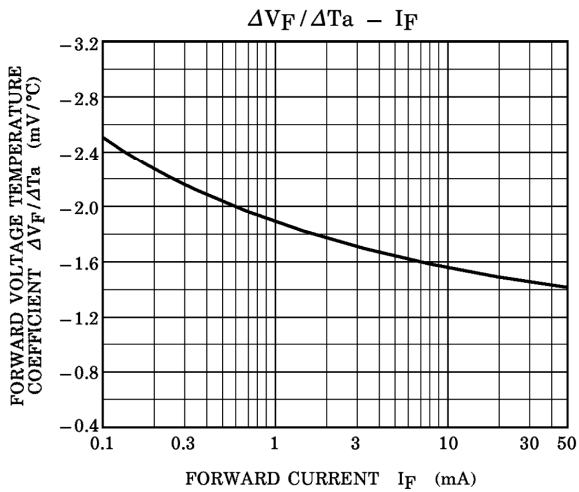
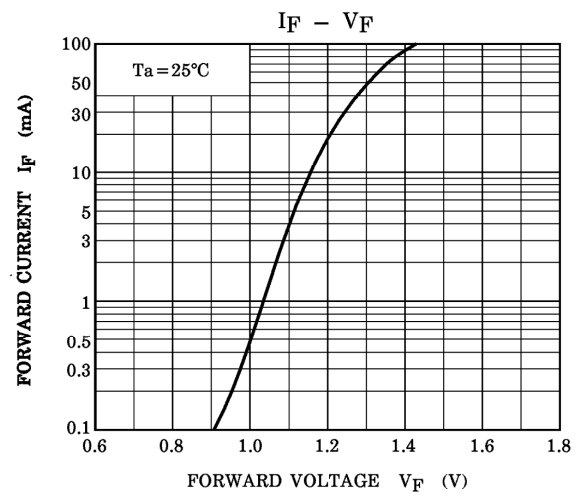
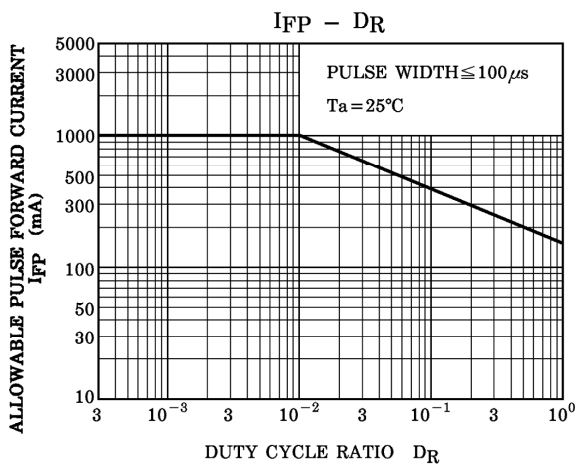
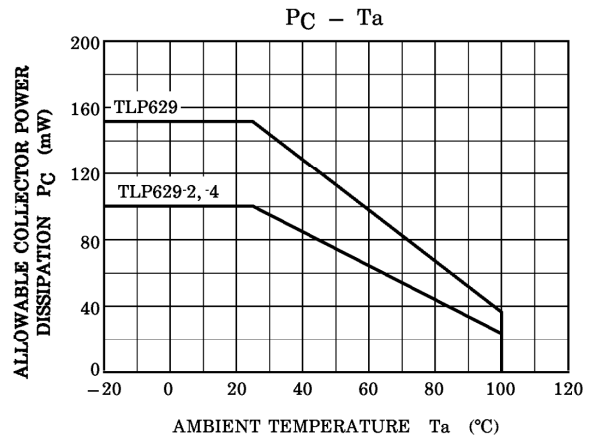
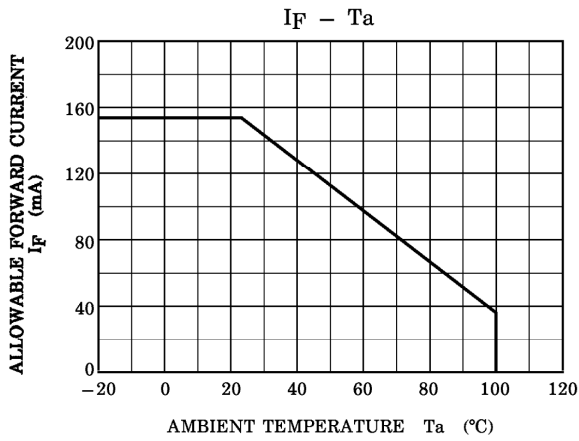

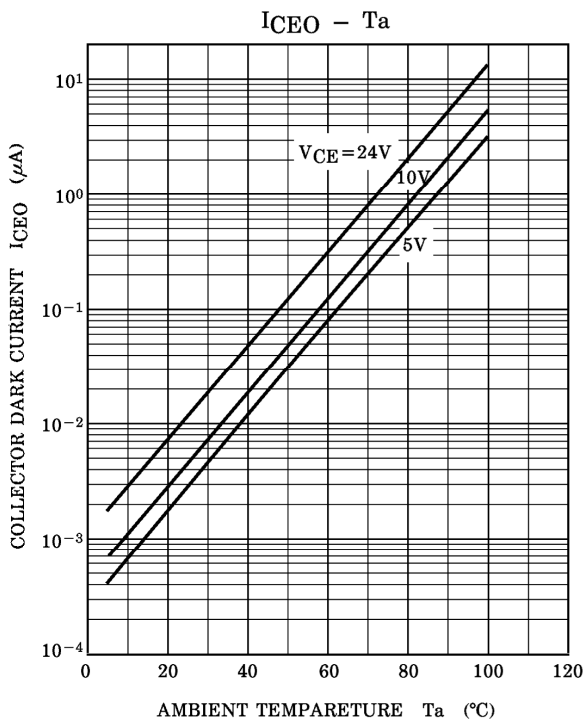
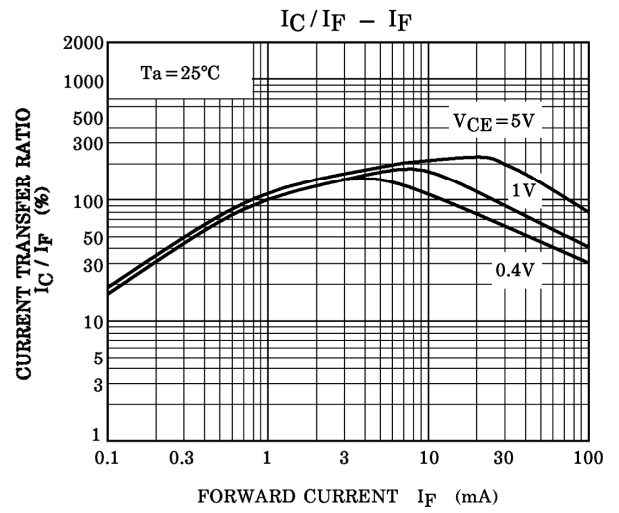
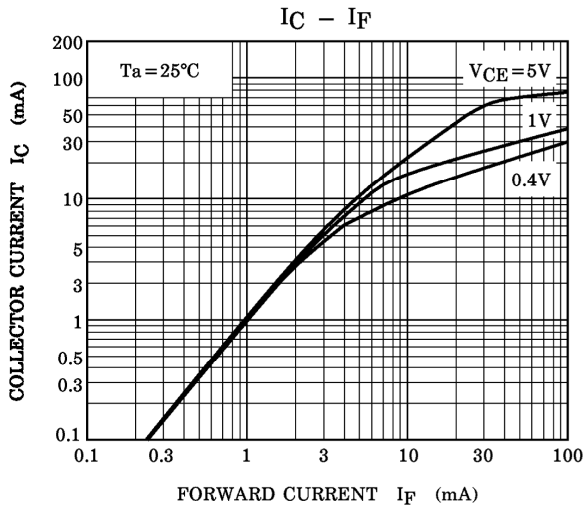

RESTRICTIONS ON PRODUCT USE

20070701-EN

- The information contained herein is subject to change without notice.
- TOSHIBA is continually working to improve the quality and reliability of its products. Nevertheless, semiconductor devices in general can malfunction or fail due to their inherent electrical sensitivity and vulnerability to physical stress. It is the responsibility of the buyer, when utilizing TOSHIBA products, to comply with the standards of safety in making a safe design for the entire system, and to avoid situations in which a malfunction or failure of such TOSHIBA products could cause loss of human life, bodily injury or damage to property.
In developing your designs, please ensure that TOSHIBA products are used within specified operating ranges as set forth in the most recent TOSHIBA products specifications. Also, please keep in mind the precautions and conditions set forth in the "Handling Guide for Semiconductor Devices," or "TOSHIBA Semiconductor Reliability Handbook" etc.
- The TOSHIBA products listed in this document are intended for usage in general electronics applications (computer, personal equipment, office equipment, measuring equipment, industrial robotics, domestic appliances, etc.). These TOSHIBA products are neither intended nor warranted for usage in equipment that requires extraordinarily high quality and/or reliability or a malfunction or failure of which may cause loss of human life or bodily injury ("Unintended Usage"). Unintended Usage include atomic energy control instruments, airplane or spaceship instruments, transportation instruments, traffic signal instruments, combustion control instruments, medical instruments, all types of safety devices, etc.. Unintended Usage of TOSHIBA products listed in this document shall be made at the customer's own risk.
- The products described in this document shall not be used or embedded to any downstream products of which manufacture, use and/or sale are prohibited under any applicable laws and regulations.
- The information contained herein is presented only as a guide for the applications of our products. No responsibility is assumed by TOSHIBA for any infringements of patents or other rights of the third parties which may result from its use. No license is granted by implication or otherwise under any patents or other rights of TOSHIBA or the third parties.
- GaAs(Gallium Arsenide) is used in this product. The dust or vapor is harmful to the human body. Do not break, cut, crush or dissolve chemically.
- Please contact your sales representative for product-by-product details in this document regarding RoHS compatibility. Please use these products in this document in compliance with all applicable laws and regulations that regulate the inclusion or use of controlled substances. Toshiba assumes no liability for damage or losses occurring as a result of noncompliance with applicable laws and regulations.