



N-Channel Enhancement-Mode Vertical DMOS FETs

Ordering Information

| BV _{DSS} / BV _{DGS} | R _{DS(ON)} (max) | I _{D(ON)} (min) | V _{GS(th)} (max) | Order Number /Package | |
|--|------------------------------|-----------------------------|------------------------------|-----------------------|----------|
| | | | | TO-243AA* | Die† |
| 18V | 2.5Ω | 250mA | 1.0V | TN2501N8 | TN2501ND |

*Same as SOT-89. Product supplied on 2000 piece carrier tape reels.

†MIL visual screening available.

Features

- Low threshold
- High input impedance
- Low input capacitance — 110pF max.
- Fast switching speeds
- Low on resistance
- Free from secondary breakdown
- Low input and output leakage

Applications

- Logic level interfaces – ideal for TTL and CMOS
- Solid state relays
- Battery operated systems
- Photo voltaic drives
- Analog switches
- General purpose line drivers
- Telecom switches

Absolute Maximum Ratings

| | |
|-----------------------------------|-------------------|
| Drain-to-Source Voltage | BV _{DSS} |
| Drain-to-Gate Voltage | BV _{DGS} |
| Gate-to-Source Voltage | ± 15V |
| Operating and Storage Temperature | -55°C to +150°C |
| Soldering Temperature* | 300°C |

*Distance of 1.6 mm from case for 10 seconds.

Product marking for TO-243AA:

TN5U*

Where * = 2-week alpha date code

Low Threshold DMOS Technology

These low threshold enhancement-mode (normally-off) transistors utilize a vertical DMOS structure and Supertex's well-proven silicon-gate manufacturing process. This combination produces devices with the power handling capabilities of bipolar transistors and with the high input impedance and positive temperature coefficient inherent in MOS devices. Characteristic of all MOS structures, these devices are free from thermal runaway and thermally-induced secondary breakdown.

Supertex's vertical DMOS FETs are ideally suited to a wide range of switching and amplifying applications where very low threshold voltage, high breakdown voltage, high input impedance, low input capacitance, and fast switching speeds are desired.

Package Option

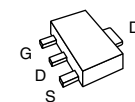

TO-243AA
(SOT-89)

Note: See Package Outline section for dimensions.

Thermal Characteristics

| Package | I_D (continuous)* | I_D (pulsed) | Power Dissipation @ $T_A = 25^\circ\text{C}$ | θ_{jc} $^\circ\text{C/W}$ | θ_{ja} $^\circ\text{C/W}$ | I_{DR}^* | I_{DRM} |
|----------|---------------------|----------------|---|-------------------------------------|-------------------------------------|------------|-----------|
| TO-243AA | 400mA | 560mA | 1.6W† | 15 | 78† | 560mA | 750mA |

* I_D (continuous) is limited by max rated T_j .

† Mounted on FR5 board, 25mm x 25mm x 1.57mm. Significant P_D increase possible on ceramic substrate.

Electrical Characteristics (@ 25°C unless otherwise specified)

| Symbol | Parameter | Min | Typ | Max | Unit | Conditions |
|---------------------|--|------|-----|------|----------------------|---|
| BV_{DSS} | Drain-to-Source Breakdown Voltage | 18 | | | V | $V_{GS} = 0V, I_D = 1.0mA$ |
| $V_{GS(th)}$ | Gate Threshold Voltage | 0.3 | | 1.0 | V | $V_{GS} = V_{DS}, I_D = 1.0mA$ |
| $\Delta V_{GS(th)}$ | Change in $V_{GS(th)}$ with Temperature | | | -4.0 | mV/ $^\circ\text{C}$ | $V_{GS} = V_{DS}, I_D = 1.0mA$ |
| I_{GSS} | Gate Body Leakage | | | 100 | nA | $V_{GS} = \pm 15V, V_{DS} = 0V$ |
| I_{DSS} | Zero Gate Voltage Drain Current | | | 10 | μA | $V_{GS} = 0V, V_{DS} = \text{Max Rating}$ |
| | | | | 1.0 | mA | $V_{GS} = 0V, V_{DS} = 0.8 \text{ Max Rating}$ $T_A = 125^\circ\text{C}$ |
| $I_{D(ON)}$ | ON-State Drain Current | 250 | 600 | | mA | $V_{GS} = V_{DS} = 3.0V$ |
| $R_{DS(ON)}$ | Static Drain-to-Source ON-State Resistance | | | 25 | Ω | $V_{GS} = 1.2V, I_D = 3.0mA$ |
| | | | | 3.5 | | $V_{GS} = 2.0V, I_D = 50mA$ |
| | | | | 2.5 | | $V_{GS} = 3.0V, I_D = 200mA$ |
| $\Delta R_{DS(ON)}$ | Change in $R_{DS(ON)}$ with Temperature | | | 0.75 | %/ $^\circ\text{C}$ | $V_{GS} = 3.0V, I_D = 200mA$ |
| G_{FS} | Forward Transconductance | 0.15 | 0.3 | | $\bar{\sigma}$ | $V_{DS} = 3.0V, I_D = 200mA$ |
| C_{ISS} | Input Capacitance | | | 110 | pF | $V_{GS} = 0V, V_{DS} = 15V$ $f = 1 \text{ MHz}$ |
| C_{OSS} | Common Source Output Capacitance | | | 60 | | |
| C_{RSS} | Reverse Transfer Capacitance | | | 35 | | |
| $t_{d(ON)}$ | Turn-ON Delay Time | | | 5.0 | ns | $V_{DD} = 15V,$ $I_D = 250mA,$ $R_{GEN} = 25\Omega$ |
| t_r | Rise Time | | | 15 | | |
| $t_{d(OFF)}$ | Turn-OFF Delay Time | | | 15 | | |
| t_f | Fall Time | | | 8.0 | | |
| V_{SD} | Diode Forward Voltage Drop | | 1.1 | 1.8 | V | $V_{GS} = 0V, I_{SD} = 200mA$ |
| t_{rr} | Reverse Recovery Time | | 100 | | ns | $V_{GS} = 0V, I_{SD} = 200mA$ |

Notes:

- All D.C. parameters 100% tested at 25°C unless otherwise stated. (Pulse test: 300 μsec pulse, 2% duty cycle.)
- All A.C. parameters sample tested.

Switching Waveforms and Test Circuit

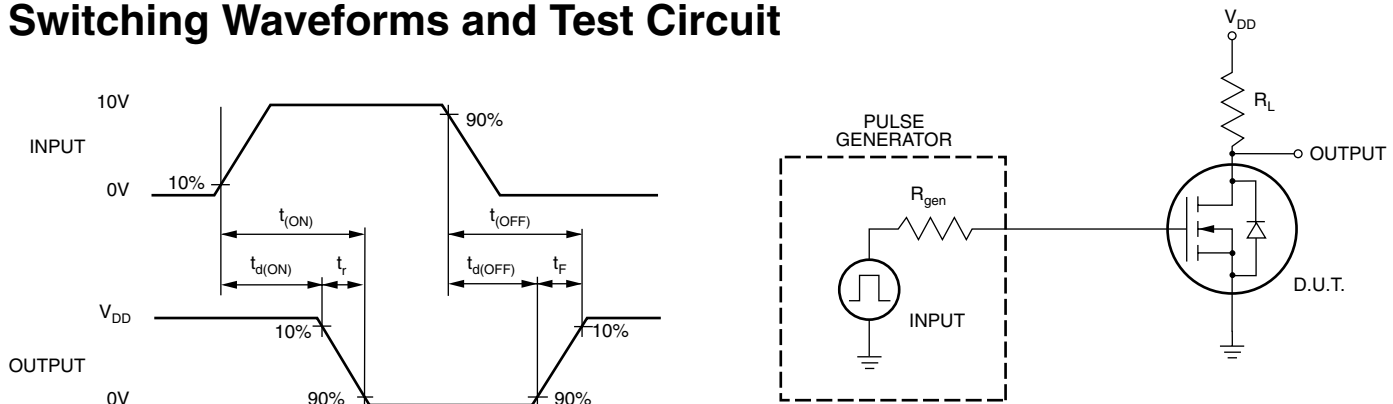

Typical Performance Curves

Output Characteristics

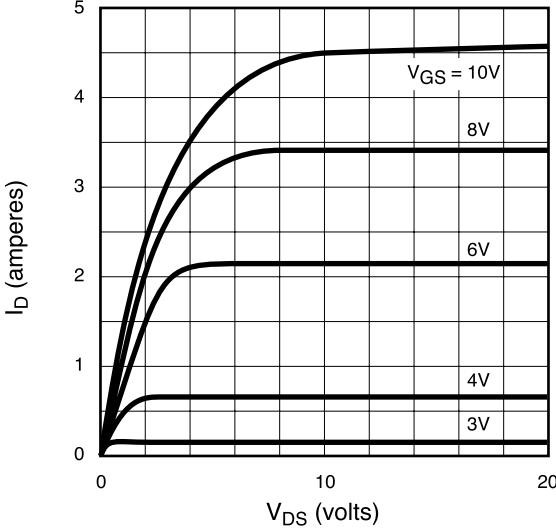

Saturation Characteristics

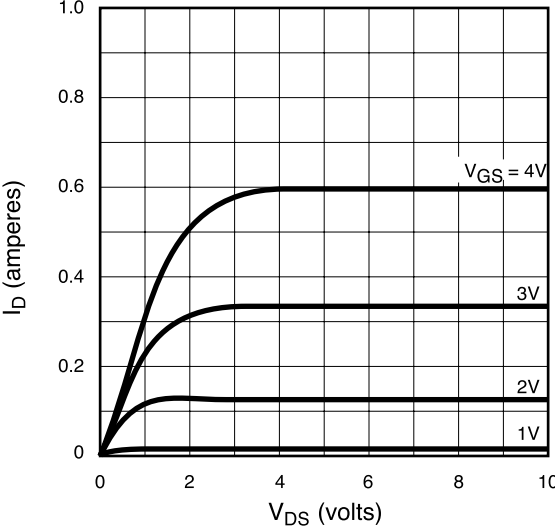

Transconductance vs. Drain Current

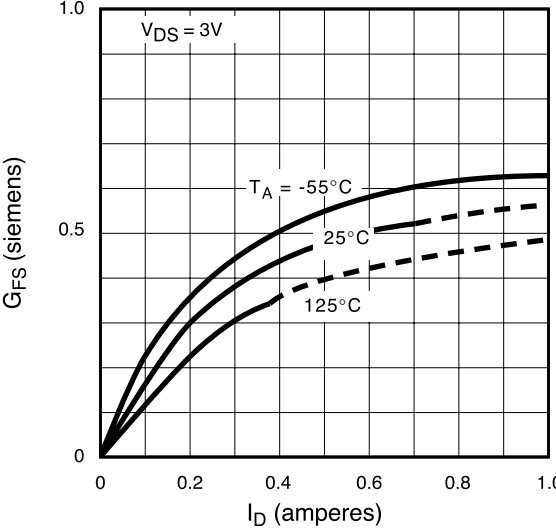

Power Dissipation vs. Ambient Temperature

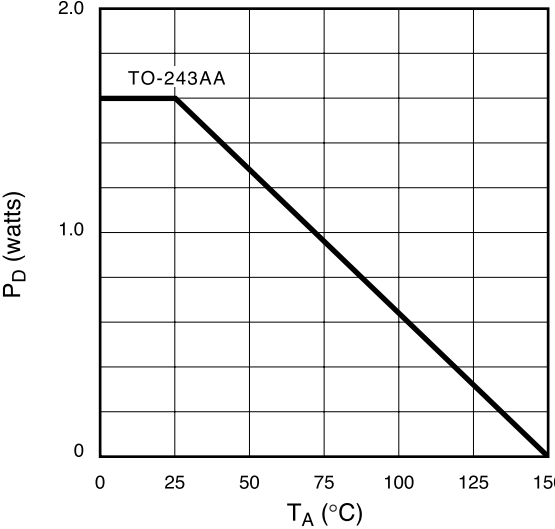

Maximum Rated Safe Operating Area

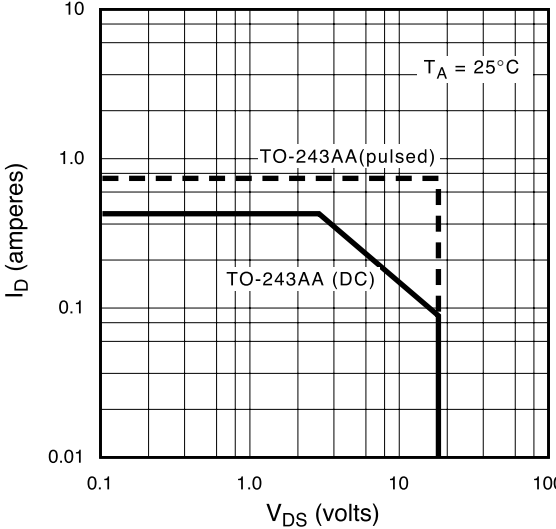

Thermal Response Characteristics

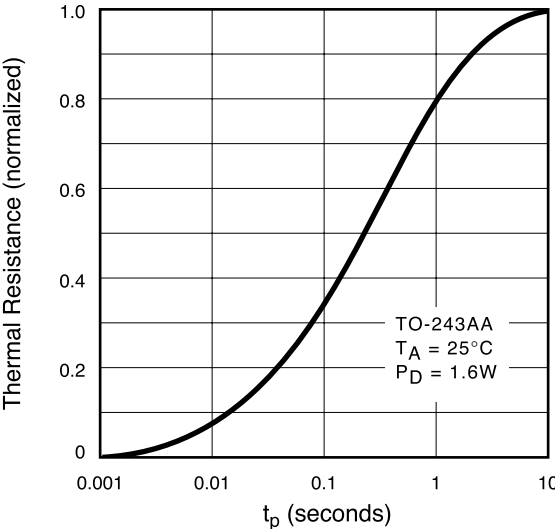

Typical Performance Curves

