

TN3725A

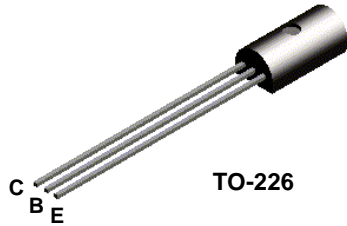

MMPQ3725

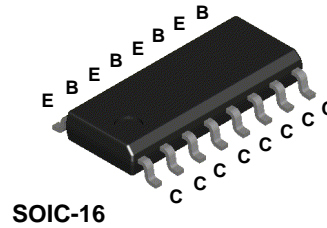

NPN Switching Transistor

This device is designed for high speed core driver applications up to collector currents of 1.0 A. Sourced from Process 25.

Absolute Maximum Ratings

TA = 25°C unless otherwise noted

| Symbol | Parameter | Value | Units |
|-----------------------------------|--|-------------|-------|
| V _{CEO} | Collector-Emitter Voltage | 40 | V |
| V _{CBO} | Collector-Base Voltage | 60 | V |
| V _{EBO} | Emitter-Base Voltage | 6.0 | V |
| I _C | Collector Current - Continuous | 1.2 | A |
| T _J , T _{stg} | Operating and Storage Junction Temperature Range | -55 to +150 | °C |

*These ratings are limiting values above which the serviceability of any semiconductor device may be impaired.

NOTES:

- 1) These ratings are based on a maximum junction temperature of 150 degrees C.
- 2) These are steady state limits. The factory should be consulted on applications involving pulsed or low duty cycle operations.

Thermal Characteristics

TA = 25°C unless otherwise noted

| Symbol | Characteristic | Max | | Units |
|------------------|--|---------|----------|-------|
| | | TN3725A | MMPQ3725 | |
| P _D | Total Device Dissipation Derate above 25°C | 1.0 | 1.0 | W |
| | | 8.0 | 8.0 | mW/°C |
| R _{θJC} | Thermal Resistance, Junction to Case | 50 | | °C/W |
| R _{θJA} | Thermal Resistance, Junction to Ambient Effective 4 Die Each Die | 125 | | °C/W |
| | | | 125 | °C/W |
| | | | 240 | °C/W |

NPN Switching Transistor

(continued)

Electrical Characteristics

TA= 25°C unless otherwise noted

| Symbol | Parameter | Test Conditions | Min | Max | Units |
|----------------------------|--------------------------------------|---|-----|------------|--------------------------------|
| OFF CHARACTERISTICS | | | | | |
| $V_{(BR)CEO}$ | Collector-Emitter Breakdown Voltage* | $I_C = 10 \text{ mA}, I_B = 0$ | 40 | | V |
| $V_{(BR)CES}$ | Collector-Emitter Breakdown Voltage | $I_C = 10 \text{ } \mu\text{A}, V_{BE} = 0$ | 60 | | V |
| $V_{(BR)CBO}$ | Collector-Base Breakdown Voltage | $I_C = 10 \text{ } \mu\text{A}, I_{CE} = 0$ | 60 | | V |
| $V_{(BR)EBO}$ | Emitter-Base Breakdown Voltage | $I_E = 10 \text{ } \mu\text{A}, I_C = 0$ | 6.0 | | V |
| I_{CBO} | Collector Cutoff Current | $V_{CB} = 60 \text{ V}, I_E = 0$ $V_{CB} = 60 \text{ V}, I_E = 0, T_A = 100^\circ\text{C}$ | | 1.7 120 | μA μA |
| I_{CES} | Collector Cutoff Current | $V_{CE} = 80 \text{ V}, V_{EB} = 0$ | | 10 | μA |

ON CHARACTERISTICS*

| | | | | | |
|---------------|--------------------------------------|---|----|------|---|
| h_{FE} | DC Current Gain | $I_C = 10 \text{ mA}, V_{CE} = 1.0 \text{ V}$ | 30 | 150 | |
| | | $I_C = 100 \text{ mA}, V_{CE} = 1.0 \text{ V}$ | 60 | | |
| | | $I_C = 100 \text{ mA}, V_{CE} = 1.0 \text{ V}, T_A = -55^\circ\text{C}$ | 30 | | |
| | | $I_C = 300 \text{ mA}, V_{CE} = 1.0 \text{ V}$ | 40 | | |
| | | $I_C = 500 \text{ mA}, V_{CE} = 1.0 \text{ V}$ | 35 | | |
| | | $I_C = 500 \text{ mA}, V_{CE} = 1.0 \text{ V}, T_A = -55^\circ\text{C}$ | 20 | | |
| | | $I_C = 800 \text{ mA}, V_{CE} = 2.0 \text{ V}$ | 20 | | |
| $V_{CE(sat)}$ | Collector-Emitter Saturation Voltage | $I_C = 10 \text{ mA}, I_B = 1.0 \text{ mA}$ | | 0.25 | V |
| | | $I_C = 100 \text{ mA}, I_B = 10 \text{ mA}$ | | 0.26 | V |
| | | $I_C = 300 \text{ mA}, I_B = 30 \text{ mA}$ | | 0.4 | V |
| | | $I_C = 500 \text{ mA}, I_B = 50 \text{ mA}$ | | 0.52 | V |
| | | $I_C = 800 \text{ mA}, I_B = 80 \text{ mA}$ | | 0.8 | V |
| $V_{BE(sat)}$ | Base-Emitter Saturation Voltage | $I_C = 1.0 \text{ A}, V_{CE} = 5.0 \text{ V}$ | | 0.95 | V |
| | | $I_C = 10 \text{ mA}, I_B = 1.0 \text{ mA}$ | | 0.76 | V |
| | | $I_C = 100 \text{ mA}, I_B = 10 \text{ mA}$ | | 0.86 | V |
| | | $I_C = 300 \text{ mA}, I_B = 30 \text{ mA}$ | | 1.1 | V |
| | | $I_C = 500 \text{ mA}, I_B = 50 \text{ mA}$ | | 1.2 | V |
| | | $I_C = 800 \text{ mA}, I_B = 80 \text{ mA}$ | | 1.5 | V |
| | | $I_C = 1.0 \text{ A}, I_B = 100 \text{ mA}$ | | 1.7 | V |

SMALL SIGNAL CHARACTERISTICS

| | | | | | |
|-----------|----------------------------------|--|-----|----|-----|
| f_T | Current Gain - Bandwidth Product | $I_C = 50 \text{ mA}, V_{CE} = 10 \text{ V},$ $f = 100 \text{ MHz}$ | 300 | | MHz |
| C_{obo} | Output Capacitance | $V_{CB} = 10 \text{ V}, I_E = 0,$ $f = 1.0 \text{ MHz}$ | | 10 | pF |
| C_{ibo} | Input Capacitance | $V_{EB} = 0.5 \text{ V}, I_C = 0,$ $f = 1.0 \text{ MHz}$ | | 55 | pF |

SWITCHING CHARACTERISTICS (except MMPQ3725)

| | | | | | |
|-----------|---------------|---|--|----|----|
| t_{on} | Turn-on Time | $V_{CC} = 30 \text{ V}, V_{BE(off)} = 3.8 \text{ V},$ $I_C = 500 \text{ mA}, I_{B1} = 50 \text{ mA}$ | | 35 | ns |
| t_d | Delay Time | | | 10 | ns |
| t_r | Rise Time | | | 30 | ns |
| t_{off} | Turn-off Time | $V_{CC} = 30 \text{ V}, I_C = 500 \text{ mA}$ $I_{B1} = I_{B2} = 50 \text{ mA}$ | | 60 | ns |
| t_s | Storage Time | | | 50 | ns |
| t_f | Fall Time | | | 30 | ns |

*Pulse Test: Pulse Width $\leq 300 \text{ } \mu\text{s}$, Duty Cycle $\leq 1.0\%$

TN3725A / MMPQ3725

DC Typical Characteristics

Typical Pulsed Current Gain vs Collector Current

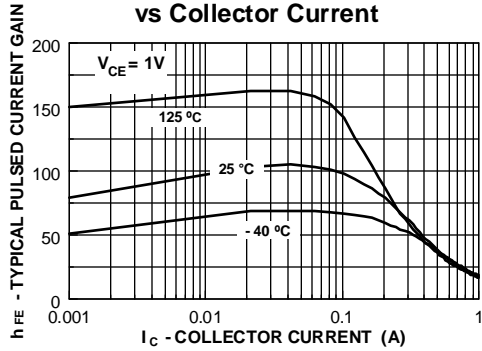

Collector-Emitter Saturation Voltage vs Collector Current

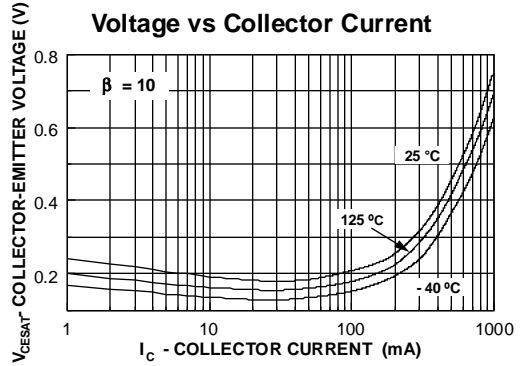

Base-Emitter Saturation Voltage vs Collector Current

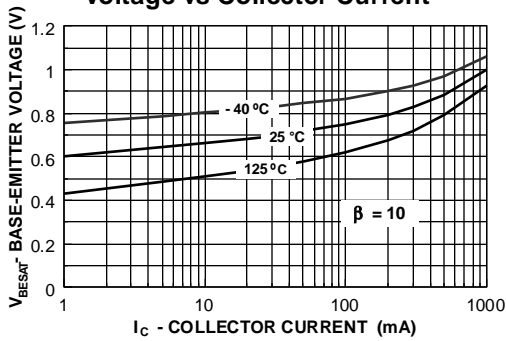

Base-Emitter ON Voltage vs Collector Current

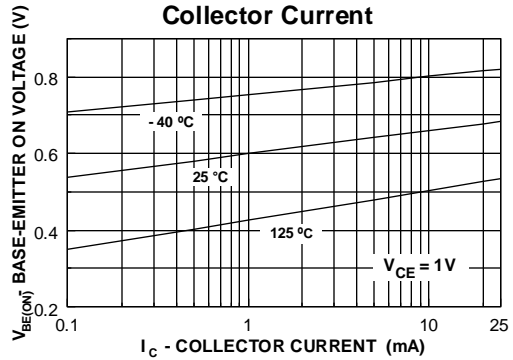

Collector-Cutoff Current vs Ambient Temperature

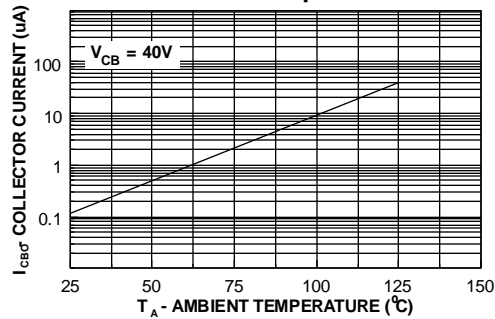

AC Typical Characteristics

Input/Output Capacitance vs. Reverse Bias

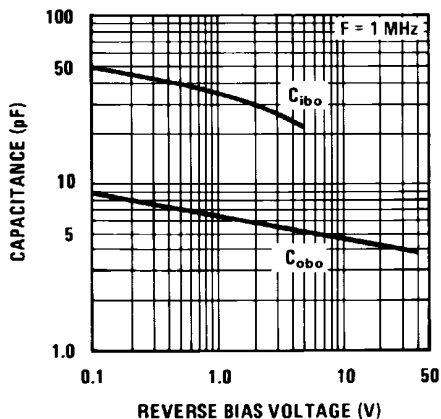

Contours of Constant Bandwidth Product (f_T)

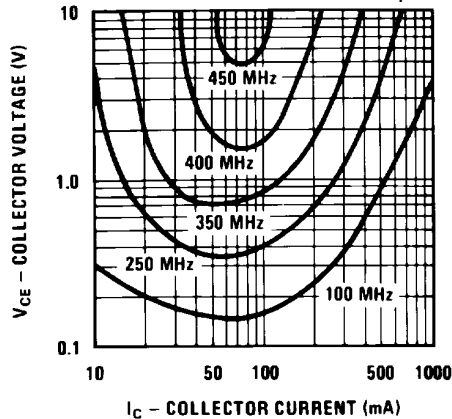

Switching Time vs. Collector Current

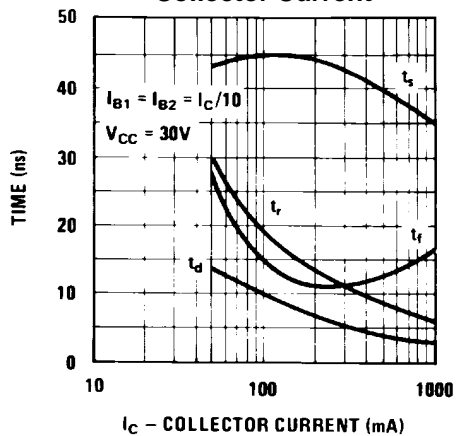

Turn On / Turn Off Times vs. Collector Current

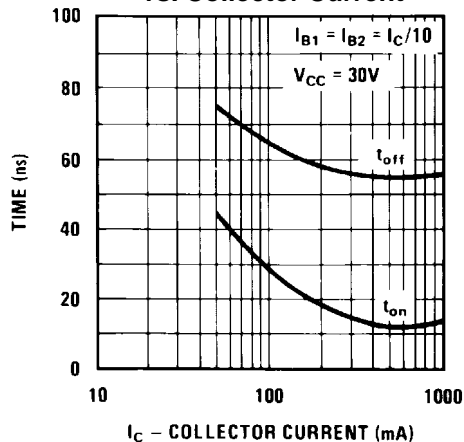

Switching Times vs. Ambient Temperature

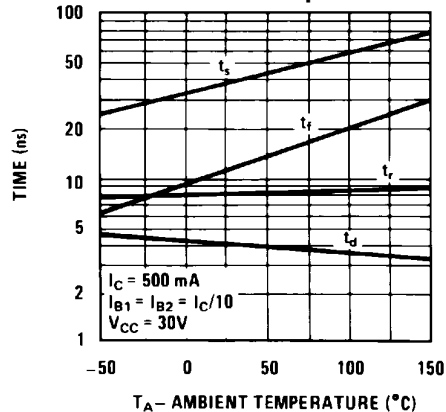

Delay Time vs. Turn On Base Current and Reverse Base-Emitter Voltage

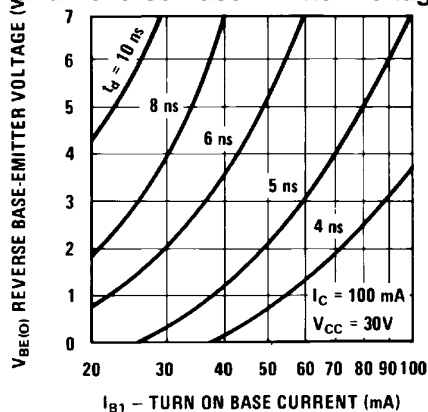

AC Typical Characteristics (continued)

Rise Time vs. Collector and Turn On Base Currents

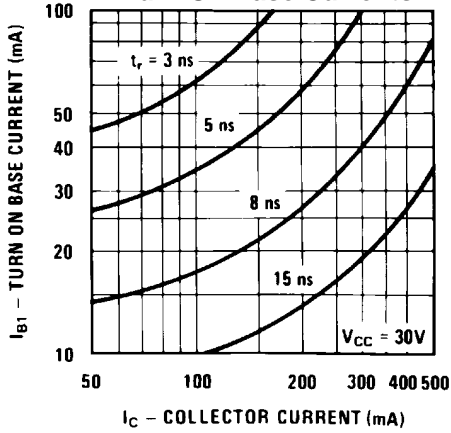

Storage Time vs. Turn On and Turn Off Base Currents

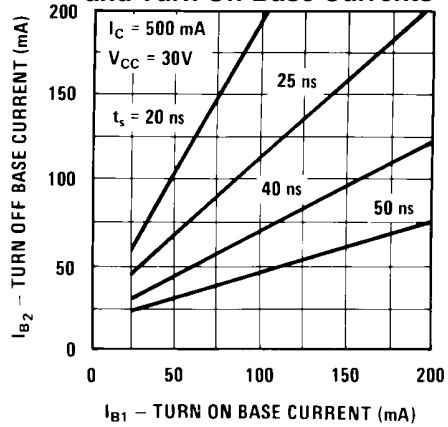

Storage Time vs. Turn On and Turn Off Base Currents

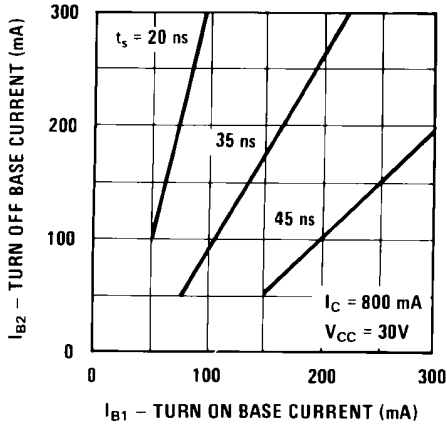

Storage Time vs. Turn On and Turn Off Base Currents

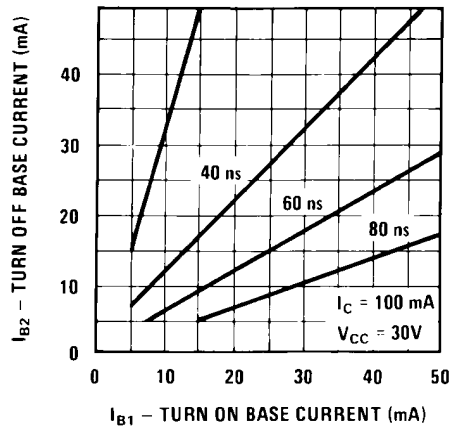

Fall Time vs. Turn On and Turn Off Base Currents

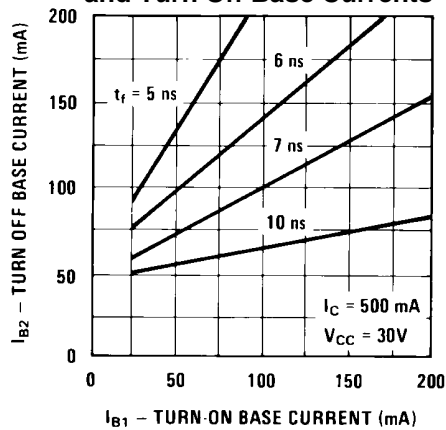

NPN Switching Transistor
(continued)

AC Typical Characteristics (continued)

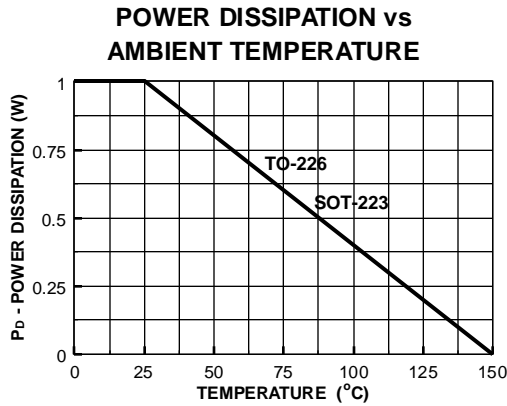
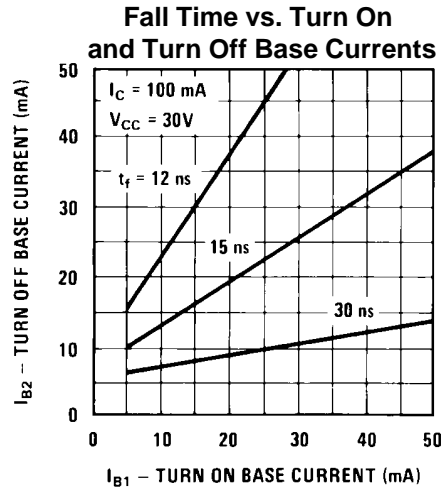
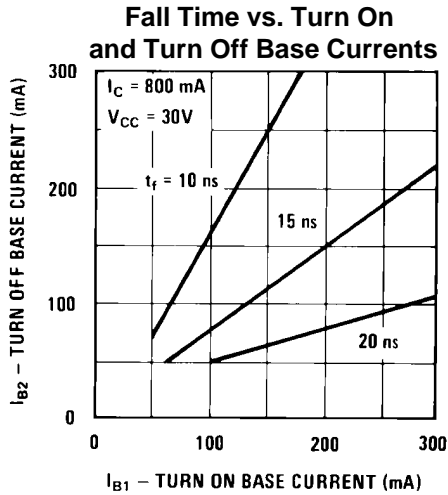

Test Circuit

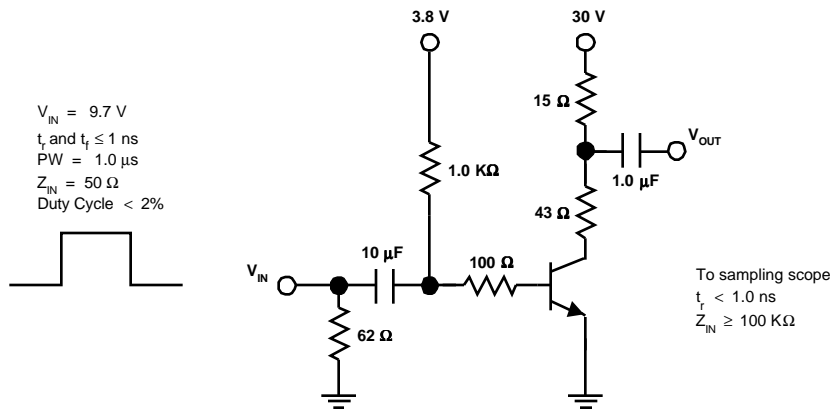

FIGURE 1: Switching Time Test Circuit
($I_C = 500 \text{ mA}$, $I_{B1} = 50 \text{ mA}$, $I_{B2} = 50 \text{ mA}$)