



TN805/TN815-B

SCR's

FEATURES

- $I_{T(RMS)} = 8\text{ A}$
- $V_{DRM} = 400\text{ V to } 800\text{ V}$
- $I_{GT} \leq 5\text{ mA and } 15\text{ mA}$

DESCRIPTION

The TN805/TN815-B serie of Silicon Controlled Rectifiers uses a high performance TOPGLASS PNP technology.

These parts are intended for general purpose applications using mount technology.

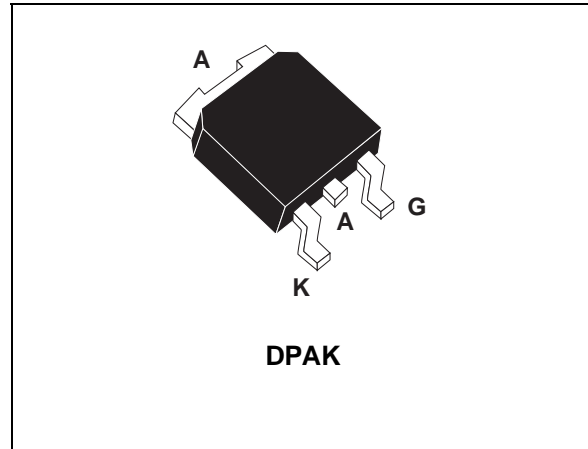

ABSOLUTE MAXIMUM RATINGS

Symbol	Parameter		Value	Unit
$I_{T(RMS)}$	RMS on-state current (180° conduction angle)	$T_c = 105^\circ\text{C}$	8	A
$I_{T(AV)}$	Mean on-state current (180° conduction angle)	$T_c = 105^\circ\text{C}$	5	A
I_{TSM}	Non repetitive surge peak on-state current (T_j initial = 25°C)	$t_p = 8.3\text{ ms}$	73	A
		$t_p = 10\text{ ms}$	70	
I^2t	I^2t Value for fusing	$t_p = 10\text{ms}$	24.5	A^2s
di/dt	Critical rate of rise of on-state current $I_G = 100\text{ mA}$ $di_G/dt = 1\text{ A}/\mu\text{s}$.		100	$\text{A}/\mu\text{s}$
T_{stg} T_j	Storage junction temperature range Operating junction temperature range		- 40 to + 150 - 40 to + 125	$^\circ\text{C}$
T_l	Maximum lead temperature for soldering during 10s		260	$^\circ\text{C}$

Symbol	Parameter	TN805 or TN815				Unit
		400B	600B	700B	800B	
V_{DRM} V_{RRM}	Repetitive peak-off voltage $T_j = 125^\circ\text{C}$	400	600	700	800	V

TN805/TN815-B

THERMAL RESISTANCES

Symbol	Parameter	Value	Unit
Rth(j-a)	Junction to ambient (S=0.5cm ²)	70	°C/W
Rth(j-c)	Junction to case for D.C	2.5	°C/W

GATE CHARACTERISTICS

$P_{G(AV)} = 1W$ $P_{GM} = 10W$ ($t_p = 20\mu s$) $I_{GM} = 4A$ ($t_p = 20\mu s$) $V_{RGM} = 5V$

ELECTRICAL CHARACTERISTICS

Symbol	Test Conditions	Type	Value		Unit
			TN805	TN815	
I_{GT}	$V_D = 12V$ (DC) $R_L = 33\Omega$ $T_j = 25^\circ C$	MAX	5	15	μA
V_{GT}	$V_D = 12V$ (DC) $R_L = 33\Omega$ $T_j = 25^\circ C$	MAX	1.5		V
V_{GD}	$V_D = V_{DRM}$ $R_L = 3.3k\Omega$ $T_j = 125^\circ C$	MIN	0.2		V
tgt	$V_D = V_{DRM}$ $I_{TM} = 3 \times I_{T(AV)}$ $I_G = 40mA$ $dI_G/dt = 0.5A/\mu s$ $T_j = 25^\circ C$	TYP	2		μs
I_H	$I_T = 150mA$ Gate open $T_j = 25^\circ C$	MAX	25	30	mA
I_L	$I_G = 1.2 I_{GT}$ $T_j = 25^\circ C$	MAX	25	30	mA
V_{TM}	$I_{TM} = 16A$ $t_p = 380\mu s$ $T_j = 25^\circ C$	MAX	1.6		V
I_{DRM}	V_{DRM} Rated $T_j = 25^\circ C$	MAX	10		μA
I_{RRM}	V_{RRM} Rated $T_j = 125^\circ C$	MAX	2		mA
dV/dt	Linear slope up to $V_D = 67\% V_{DRM}$ Gate open $T_j = 125^\circ C$	MIN	50	150	V/ μs

ORDERING INFORMATION

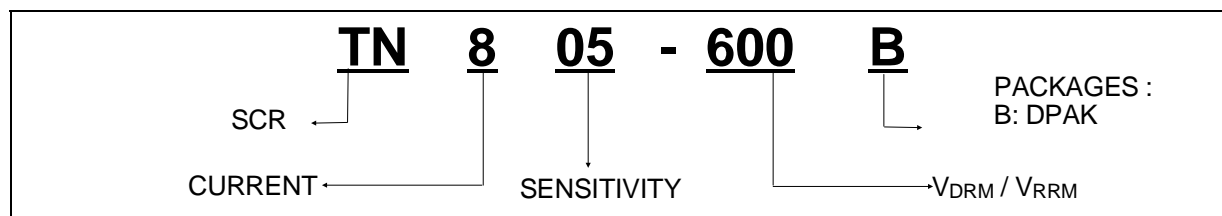

Fig. 1: Maximum average power dissipation versus average on-state current .

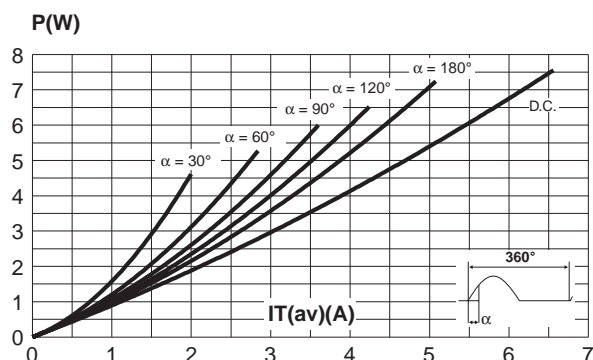

Fig. 2 : Correlation between maximum average power dissipation and maximum allowable temperatures (T_{amb} and T_{case}) for different thermal resistances heatsink+contact.

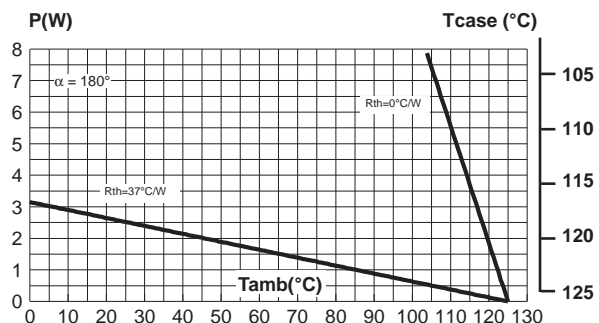

Fig. 3-1: Average and D.C. on-state current versus case temperature.

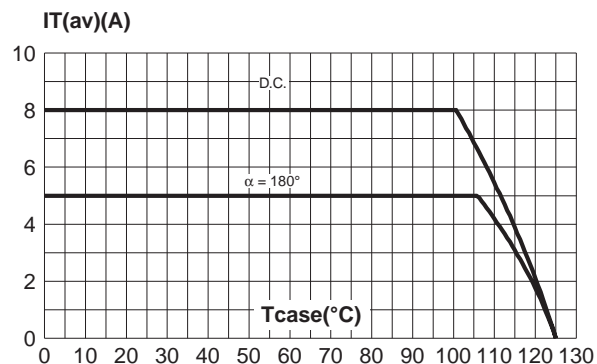

Fig. 3-2: Average and D.C. on-state current versus case temperature.

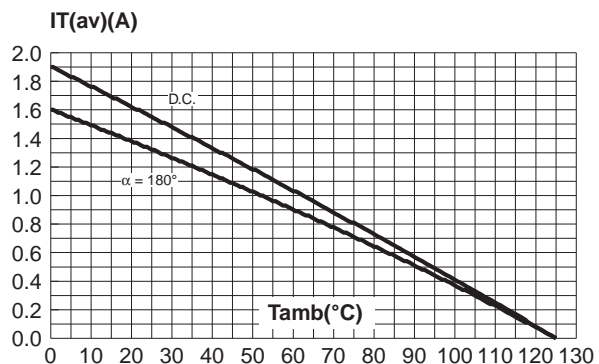

Fig. 4-1: Relative variation of thermal impedance versus pulse duration.

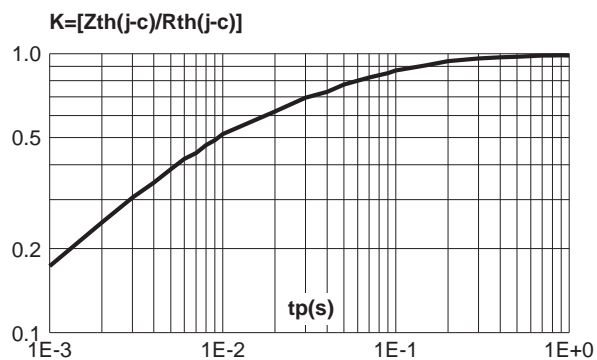

Fig. 4-2: Relative variation of thermal impedance versus pulse duration.

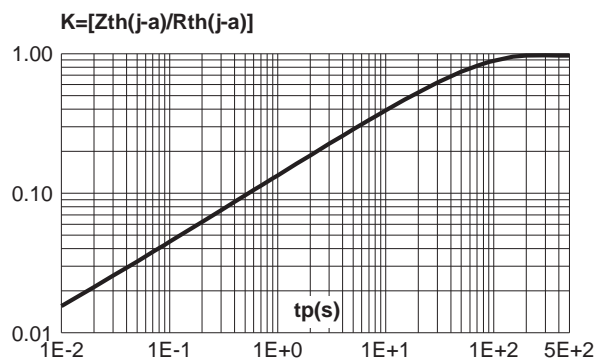

Fig. 5: Relative variation of gate trigger current and holding current versus junction temperature.

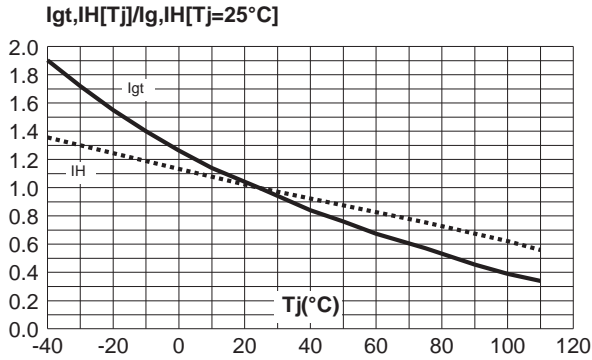

Fig. 6: Non repetitive surge peak on-state current versus number of cycles.

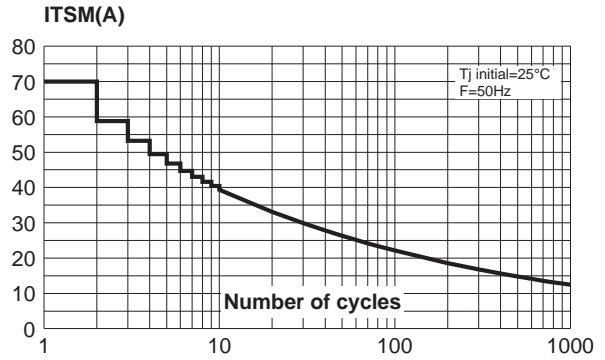

Fig. 7: Non repetitive surge peak on-state current for a sinusoidal pulse with width $t_p < 10\text{ms}$, and corresponding value of I^2t .

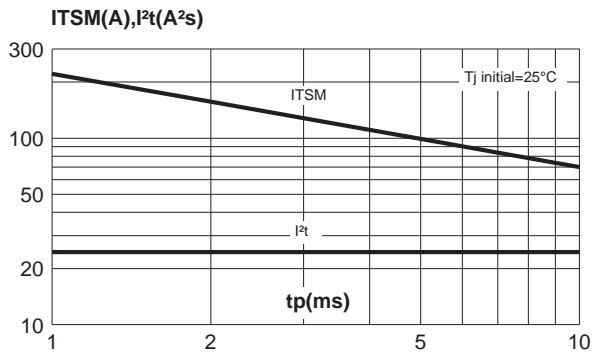

Fig. 8: On-state characteristics (maximum values).

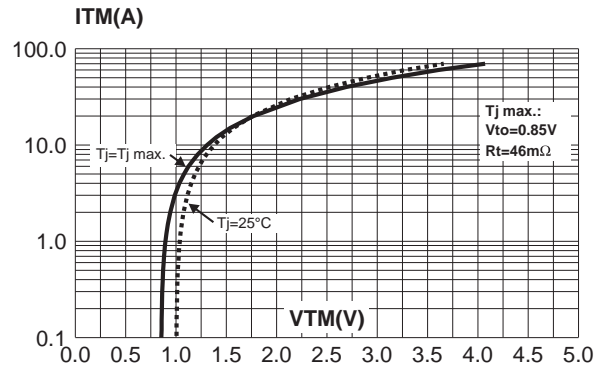
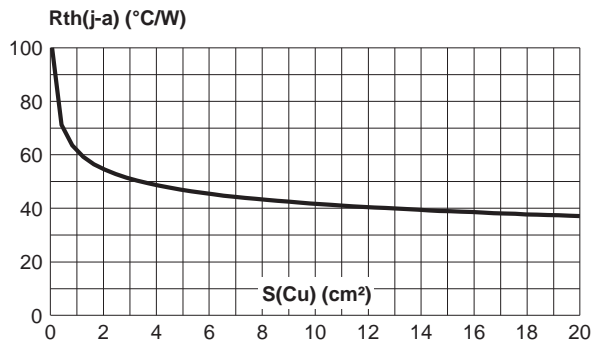
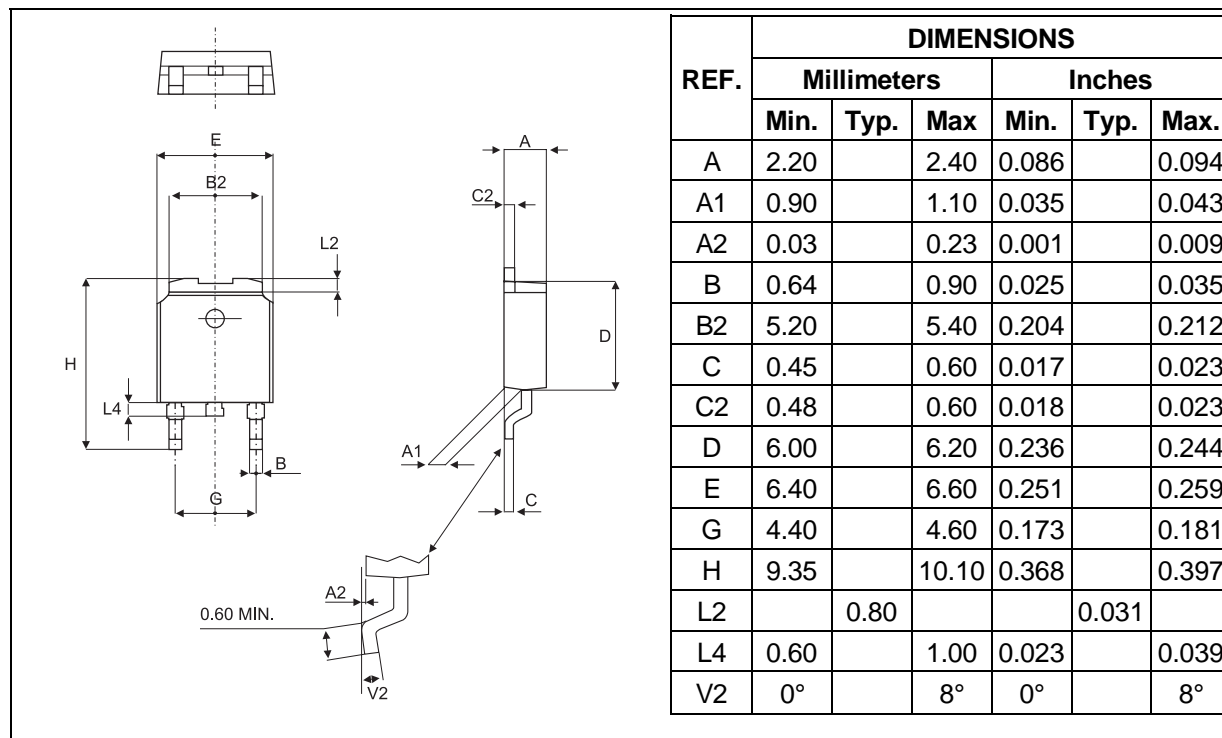

Fig. 9: Thermal resistance junction to ambient versus copper surface under tab (Epoxy printed circuit board FR4, copper thickness: 35µm).



PACKAGE MECHANICAL DATA
DPAK



FOOT PRINT DIMENSIONS (in millimeters)

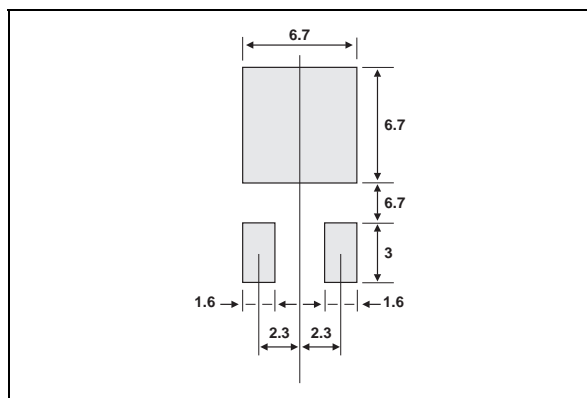

WEIGHT : 0.30g

MARKING

TYPE	MARKING
T805- x00B	TN8 05x0
T815-x00B	TN8 15x0

Information furnished is believed to be accurate and reliable. However, STMicroelectronics assumes no responsibility for the consequences of use of such information nor for any infringement of patents or other rights of third parties which may result from its use. No license is granted by implication or otherwise under any patent or patent rights of STMicroelectronics. Specifications mentioned in this publication are subject to change without notice. This publication supersedes and replaces all information previously supplied. STMicroelectronics products are not authorized for use as critical components in life support devices or systems without express written approval of STMicroelectronics.

The ST logo is a registered trademark of STMicroelectronics

© 1998 STMicroelectronics - Printed in Italy - All rights reserved.

STMicroelectronics GROUP OF COMPANIES

Australia - Brazil - Canada - China - France - Germany - Italy - Japan - Korea - Malaysia - Malta - Mexico - Morocco - The Netherlands - Singapore - Spain - Sweden - Switzerland - Taiwan - Thailand - United Kingdom - U.S.A.

