



P-Channel Enhancement-Mode Vertical DMOS FETs

Ordering Information

BV _{DSS} / BV _{DGS}	R _{DS(ON)} (max)	I _{D(ON)} (min)	V _{GS(th)} (max)	Order Number / Package
				TO-92
-60V	3.5Ω	-1.5A	-2.4V	TP0606N3

Features

- Low threshold — -2.4V max
- High input impedance
- Low input capacitance — 80pF typical
- Fast switching speeds
- Low on resistance
- Free from secondary breakdown
- Low input and output leakage
- Complementary N- and P-channel devices

Applications

- Logic level interfaces – ideal for TTL and CMOS
- Solid state relays
- Battery operated systems
- Photo voltaic drives
- Analog switches
- General purpose line drivers
- Telecom switches

Absolute Maximum Ratings

Drain-to-Source Voltage	BV _{DSS}
Drain-to-Gate Voltage	BV _{DGS}
Gate-to-Source Voltage	± 20V
Operating and Storage Temperature	-55°C to +150°C
Soldering Temperature*	300°C

* Distance of 1.6 mm from case for 10 seconds.

Low Threshold DMOS Technology

These low threshold enhancement-mode (normally-off) transistors utilize a vertical DMOS structure and Supertex's well-proven silicon-gate manufacturing process. This combination produces devices with the power handling capabilities of bipolar transistors and with the high input impedance and positive temperature coefficient inherent in MOS devices. Characteristic of all MOS structures, these devices are free from thermal runaway and thermally-induced secondary breakdown.

Supertex's vertical DMOS FETs are ideally suited to a wide range of switching and amplifying applications where very low threshold voltage, high breakdown voltage, high input impedance, low input capacitance, and fast switching speeds are desired.

Package Options

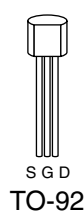

S G D
TO-92

Note 1: See Package Outline section for dimensions.
Note 2: See Array section for quad pinouts.

Thermal Characteristics

Package	I_D (continuous)*	I_D (pulsed)	Power Dissipation @ $T_C = 25^\circ\text{C}$	θ_{jc} $^\circ\text{C/W}$	θ_{ja} $^\circ\text{C/W}$	I_{DR}^*	I_{DRM}
TO-92	0.32A	-3.5A	1W	125	170	0.32A	-3.5A

* I_D (continuous) is limited by max rated T_j .

Electrical Characteristics (@ 25°C unless otherwise specified)

Symbol	Parameter	Min	Typ	Max	Unit	Conditions
BV_{DSS}	Drain-to-Source Breakdown Voltage	-60			V	$V_{GS} = 0V, I_D = -2.0mA$
$V_{GS(th)}$	Gate Threshold Voltage	-1.0		-2.4	V	$V_{GS} = V_{DS}, I_D = -1.0mA$
$\Delta V_{GS(th)}$	Change in $V_{GS(th)}$ with Temperature			-5.0	mV/ $^\circ\text{C}$	$V_{GS} = V_{DS}, I_D = -1.0mA$
I_{GSS}	Gate Body Leakage			-100	nA	$V_{GS} = \pm 20V, V_{DS} = 0V$
I_{DSS}	Zero Gate Voltage Drain Current			-10	μA	$V_{GS} = 0V, V_{DS} = \text{Max Rating}$
				-1.0	mA	$V_{GS} = 0V, V_{DS} = 0.8 \text{ Max Rating}$ $T_A = 125^\circ\text{C}$
$I_{D(ON)}$	ON-State Drain Current	-0.4	-0.6		A	$V_{GS} = -5V, V_{DS} = -25V$
		-1.5	-2.5			$V_{GS} = -10V, V_{DS} = -25V$
$R_{DS(ON)}$	Static Drain-to-Source ON-State Resistance		5.0	7.0	Ω	$V_{GS} = -5V, I_D = -250mA$
			3.0	3.5		$V_{GS} = -10V, I_D = -0.75A$
$\Delta R_{DS(ON)}$	Change in $R_{DS(ON)}$ with Temperature			1.7	%/ $^\circ\text{C}$	$V_{GS} = -10V, I_D = -0.75A$
G_{FS}	Forward Transconductance	300	400		m \bar{S}	$V_{DS} = -25V, I_D = -0.75A$
C_{ISS}	Input Capacitance		80	150	μF	$V_{GS} = 0V, V_{DS} = -25V$ $f = 1 \text{ MHz}$
C_{OSS}	Common Source Output Capacitance		50	85		
C_{RSS}	Reverse Transfer Capacitance		15	35		
$t_{d(ON)}$	Turn-ON Delay Time			10	ns	$V_{DD} = -25V$ $I_D = -1.0A$ $R_{GEN} = 25\Omega$
t_r	Rise Time			15		
$t_{d(OFF)}$	Turn-OFF Delay Time			20		
t_f	Fall Time			15		
V_{SD}	Diode Forward Voltage Drop			-1.8	V	$V_{GS} = 0V, I_{SD} = -1.0A$
t_{rr}	Reverse Recovery Time		300		ns	$V_{GS} = 0V, I_{SD} = -1.0A$

Notes:

1. All D.C. parameters 100% tested at 25°C unless otherwise stated. (Pulse test: 300 μs pulse, 2% duty cycle.)
2. All A.C. parameters sample tested.

Switching Waveforms and Test Circuit

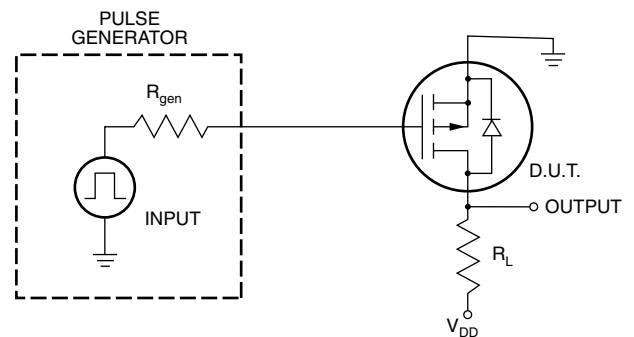
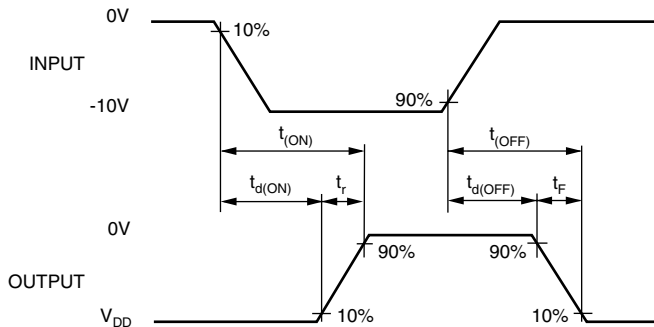

Typical Performance Curves

Output Characteristics

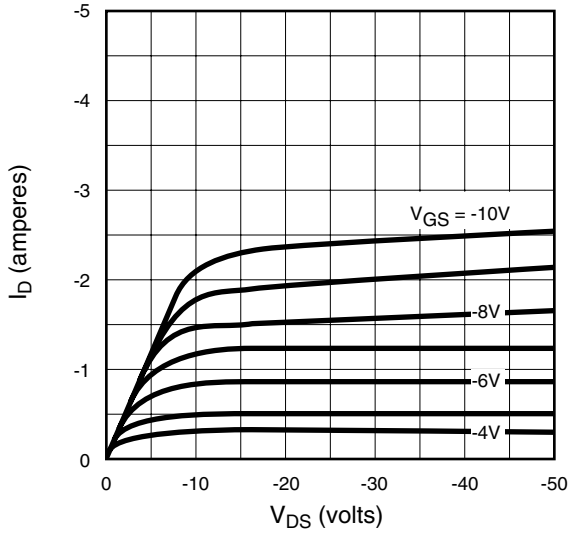

Saturation Characteristics

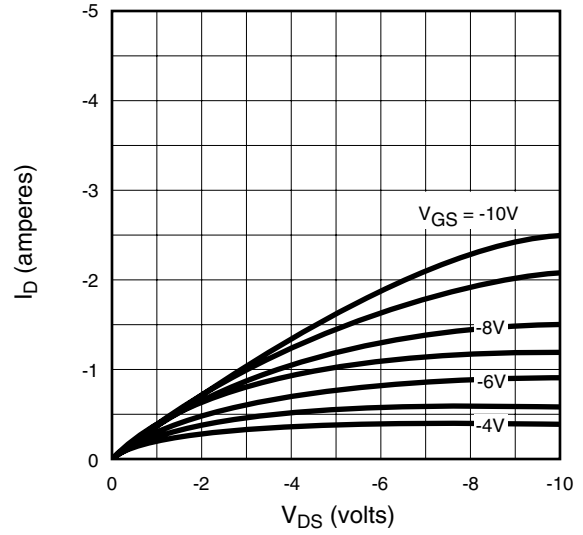

Transconductance vs. Drain Current

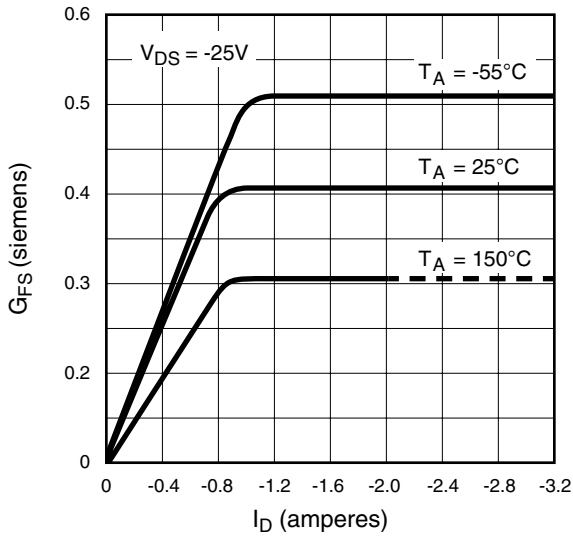

Power Dissipation vs. Case Temperature

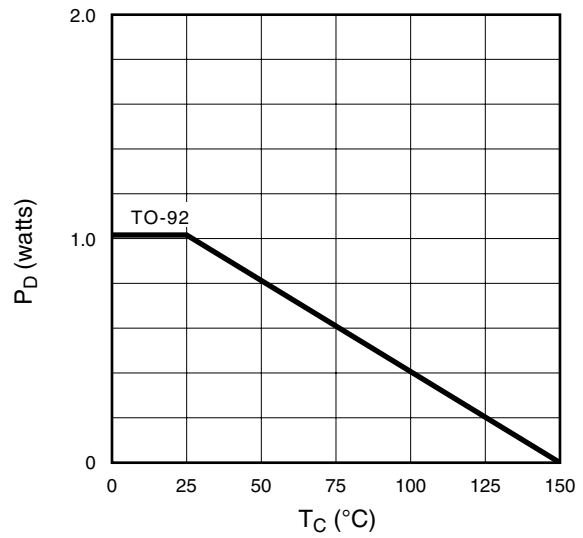

Maximum Rated Safe Operating Area

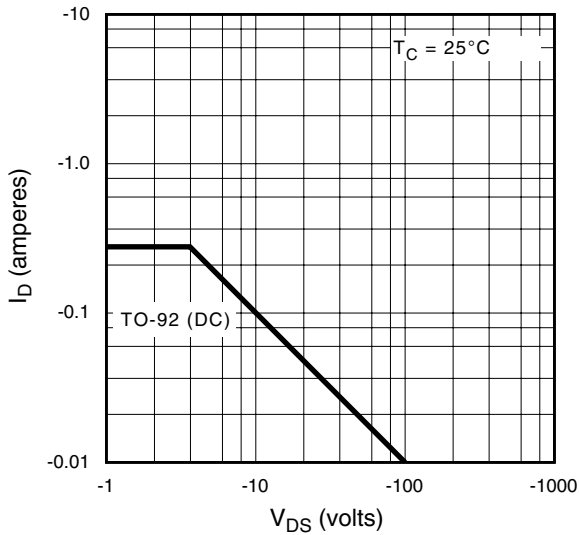

Thermal Response Characteristics

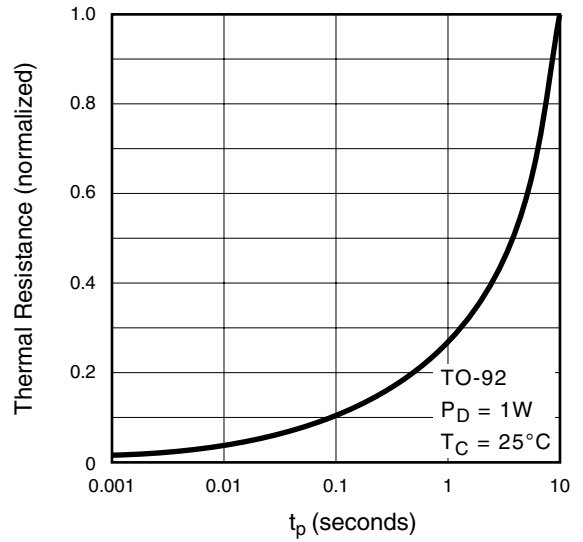

Typical Performance Curves

BV_{DSS} Variation with Temperature

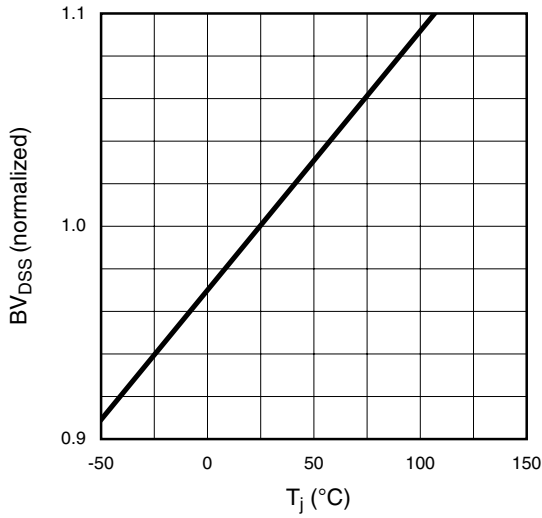

On-Resistance vs. Drain Current

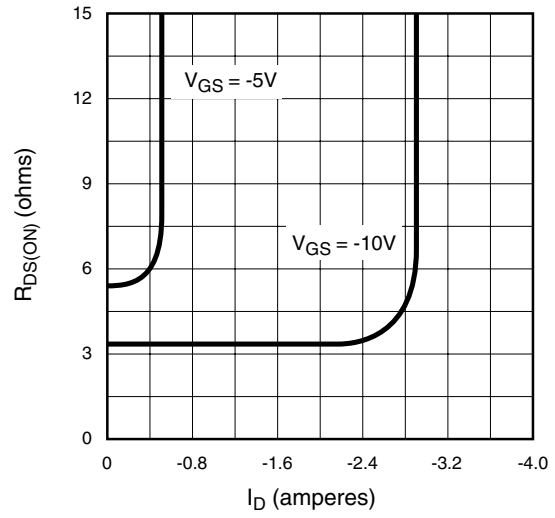

Transfer Characteristics

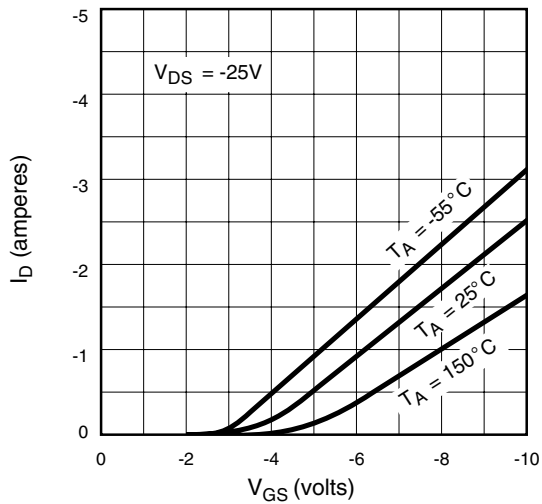

$V_{(th)}$ and R_{DS} Variation with Temperature

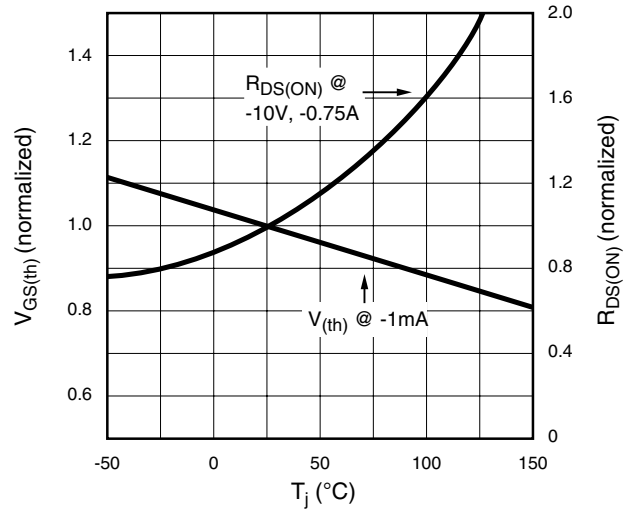

Capacitance vs. Drain-to-Source Voltage

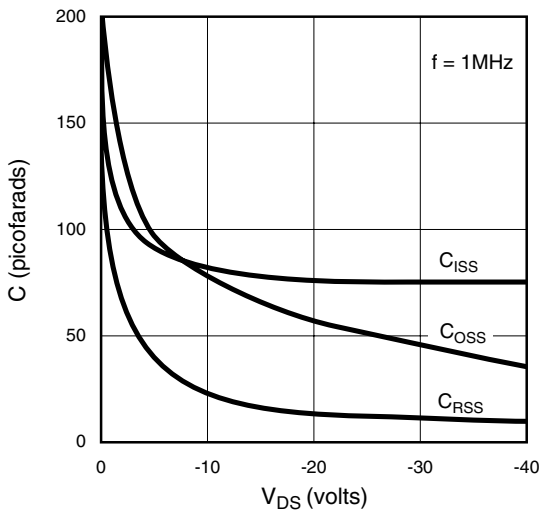

Gate Drive Dynamic Characteristics

