

Infrared Emitting Diode, RoHS Compliant, 875 nm, GaAIAs

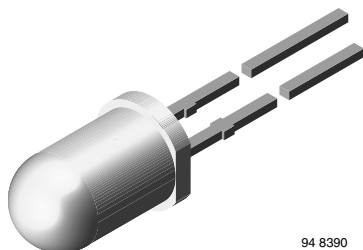

94 8390

DESCRIPTION

The TSHA550. series are infrared, 875 nm emitting diodes in GaAIAs on GaAIAs technology, molded in a clear, untinted plastic package.

FEATURES

- Package type: leaded
- Package form: T-1 $\frac{3}{4}$
- Dimensions (in mm): \varnothing 5
- Leads with stand-off
- Peak wavelength: $\lambda_p = 875$ nm
- High reliability
- Angle of half intensity: $\varphi = \pm 24^\circ$
- Low forward voltage
- Suitable for high pulse current operation
- Good spectral matching with Si photodetectors
- Lead (Pb)-free component in accordance with RoHS 2002/95/EC and WEEE 2002/96/EC



RoHS
COMPLIANT

APPLICATIONS

- Infrared remote control and free air data transmission systems with comfortable radiation angle
- This emitter series is dedicated to systems with panes in transmission space between emitter and detector, because of the low absorption of 875 nm radiation in glass

PRODUCT SUMMARY				
COMPONENT	I_e (mW/sr)	φ (deg)	λ_p (nm)	t_r (ns)
TSHA5500	20	± 24	875	600
TSHA5501	25	± 24	875	600
TSHA5502	30	± 24	875	600
TSHA5503	35	± 24	875	600

Note

Test conditions see table "Basic Characteristics"

ORDERING INFORMATION			
ORDERING CODE	PACKAGING	REMARKS	PACKAGE FORM
TSHA5500	Bulk	MOQ: 4000 pcs, 4000 pcs/bulk	T-1 $\frac{3}{4}$
TSHA5501	Bulk	MOQ: 4000 pcs, 4000 pcs/bulk	T-1 $\frac{3}{4}$
TSHA5502	Bulk	MOQ: 4000 pcs, 4000 pcs/bulk	T-1 $\frac{3}{4}$
TSHA5503	Bulk	MOQ: 4000 pcs, 4000 pcs/bulk	T-1 $\frac{3}{4}$

Note

MOQ: minimum order quantity

ABSOLUTE MAXIMUM RATINGS				
PARAMETER	TEST CONDITION	SYMBOL	VALUE	UNIT
Reverse voltage		V_R	5	V
Forward current		I_F	100	mA
Peak forward current	$t_p/T = 0.5$, $t_p = 100 \mu s$	I_{FM}	200	mA
Surge forward current	$t_p = 100 \mu s$	I_{FSM}	2.5	A
Power dissipation		P_V	180	mW



TSHA5500, TSHA5501, TSHA5502, TSHA5503

Infrared Emitting Diode, RoHS Compliant, Vishay Semiconductors
875 nm, GaAlAs

ABSOLUTE MAXIMUM RATINGS				
PARAMETER	TEST CONDITION	SYMBOL	VALUE	UNIT
Junction temperature		T_j	100	°C
Operating temperature range		T_{amb}	- 40 to + 85	°C
Storage temperature range		T_{stg}	- 40 to + 100	°C
Soldering temperature	$t \leq 5$ s, 2 mm from case	T_{sd}	260	°C
Thermal resistance junction/ambient	J-STD-051, leads 7 mm, soldered on PCB	R_{thJA}	230	K/W

Note

$T_{amb} = 25$ °C, unless otherwise specified

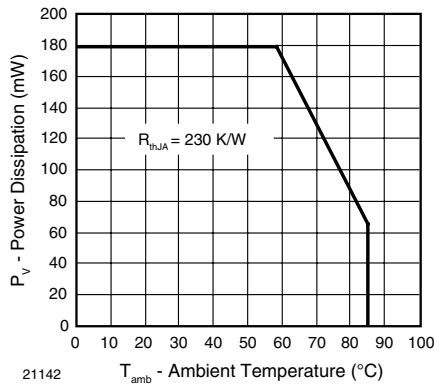

Fig. 1 - Power Dissipation Limit vs. Ambient Temperature

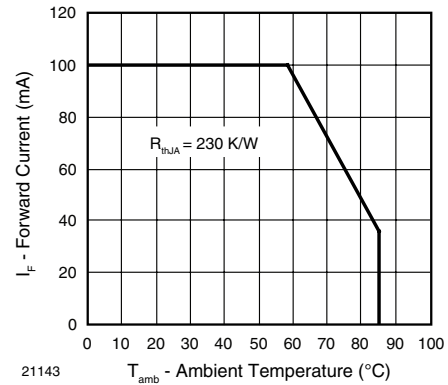

Fig. 2 - Forward Current Limit vs. Ambient Temperature

BASIC CHARACTERISTICS						
PARAMETER	TEST CONDITION	SYMBOL	MIN.	TYP.	MAX.	UNIT
Forward voltage	$I_F = 100$ mA, $t_p = 20$ ms	V_F		1.5	1.8	V
Temperature coefficient of V_F	$I_F = 100$ mA	TK_{V_F}		- 1.6		mV/K
Reverse current	$V_R = 5$ V	I_R			100	μA
Junction capacitance	$V_R = 0$ V, $f = 1$ MHz, $E = 0$	C_j		20		pF
Temperature coefficient of ϕ_e	$I_F = 20$ mA	TK_{ϕ_e}		- 0.7		%/K
Angle of half intensity		ϕ		± 24		deg
Peak wavelength	$I_F = 100$ mA	λ_p		875		nm
Spectral bandwidth	$I_F = 100$ mA	$\Delta\lambda$		80		nm
Temperature coefficient of λ_p	$I_F = 100$ mA	TK_{λ_p}		0.2		nm/K
Rise time	$I_F = 100$ mA	t_r		600		ns
	$I_F = 1.5$ A	t_r		300		ns
Fall time	$I_F = 100$ mA	t_f		600		ns
	$I_F = 1.5$ A	t_f		300		ns
Virtual source diameter		d		2.2		mm

Note

$T_{amb} = 25$ °C, unless otherwise specified

TSHA5500, TSHA5501, TSHA5502, TSHA5503



Vishay Semiconductors Infrared Emitting Diode, RoHS Compliant,
875 nm, GaAlAs

TYPE DEDICATED CHARACTERISTICS								
PARAMETER	TEST CONDITION	PART	SYMBOL	MIN.	TYP.	MAX.	UNIT	
Forward voltage	$I_F = 1.5 \text{ A}$, $t_p = 100 \mu\text{s}$	TSHA5500	V_F		3.2	4.9	V	
		TSHA5501	V_F		3.2	4.9	V	
		TSHA5502	V_F			3.2	4.5	V
		TSHA5203	V_F			3.2	4.5	V
Radiant intensity	$I_F = 100 \text{ mA}$, $t_p = 20 \text{ ms}$	TSHA5500	I_e	12	20	60	mW/sr	
		TSHA5501	I_e	16	25	60	mW/sr	
		TSHA5502	I_e	20	30	60	mW/sr	
		TSHA5503	I_e	24	35	60	mW/sr	
	$I_F = 1.5 \text{ A}$, $t_p = 100 \mu\text{s}$	TSHA5500	I_e	150	240		mW/sr	
		TSHA5501	I_e	200	300		mW/sr	
		TSHA5502	I_e	250	360		mW/sr	
		TSHA5503	I_e	300	420		mW/sr	
Radiant power	$I_F = 100 \text{ mA}$, $t_p = 20 \text{ ms}$	TSHA5500	ϕ_e		22		mW	
		TSHA5501	ϕ_e		23		mW	
		TSHA5502	ϕ_e		24		mW	
		TSHA5503	ϕ_e		25		mW	

Note

$T_{amb} = 25 \text{ }^\circ\text{C}$, unless otherwise specified

BASIC CHARACTERISTICS

$T_{amb} = 25 \text{ }^\circ\text{C}$, unless otherwise specified

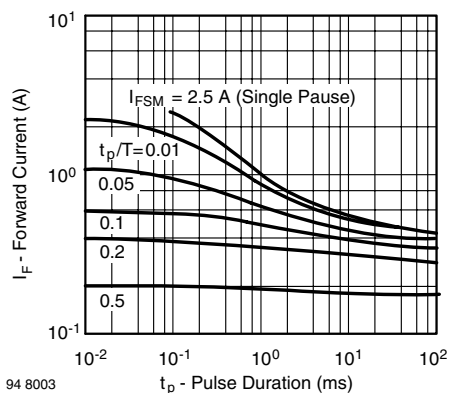

Fig. 3 - Pulse Forward Current vs. Pulse Duration

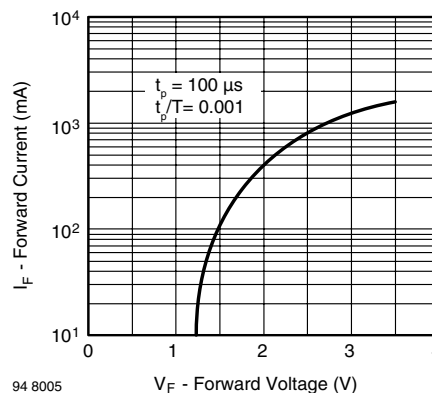

Fig. 4 - Forward Current vs. Forward Voltage



TSHA5500, TSHA5501, TSHA5502, TSHA5503

Infrared Emitting Diode, RoHS Compliant, Vishay Semiconductors
875 nm, GaAlAs

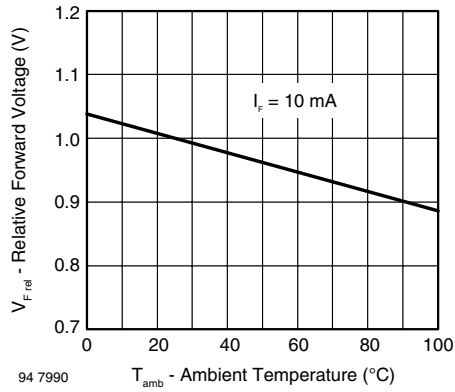

Fig. 5 - Relative Forward Voltage vs. Ambient Temperature

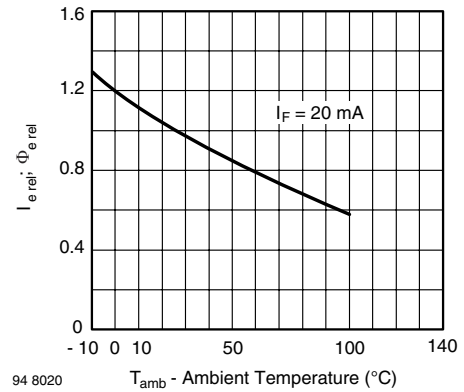

Fig. 8 - Relative Radiant Intensity/Power vs. Ambient Temperature

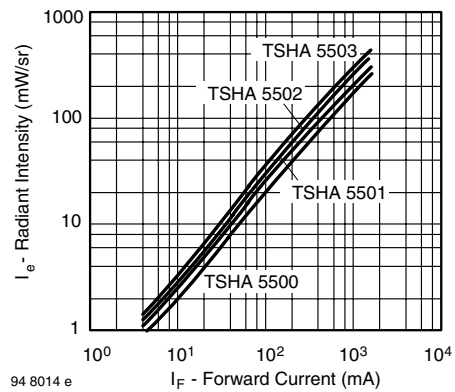

Fig. 6 - Radiant Intensity vs. Forward Current

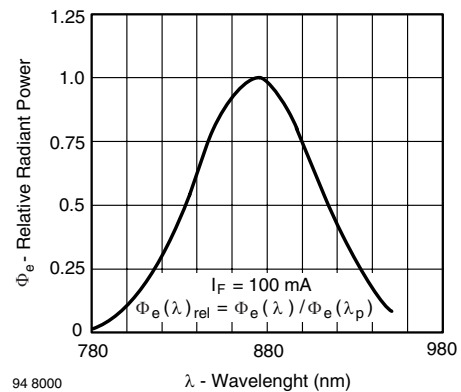

Fig. 9 - Relative Radiant Power vs. Wavelength

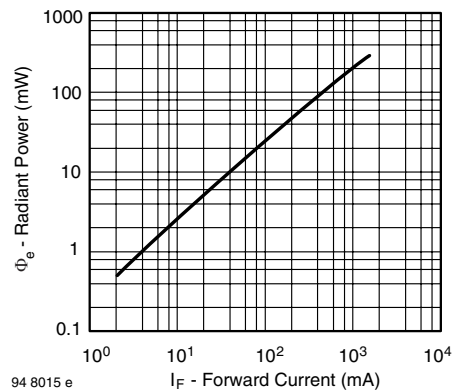

Fig. 7 - Radiant Power vs. Forward Current

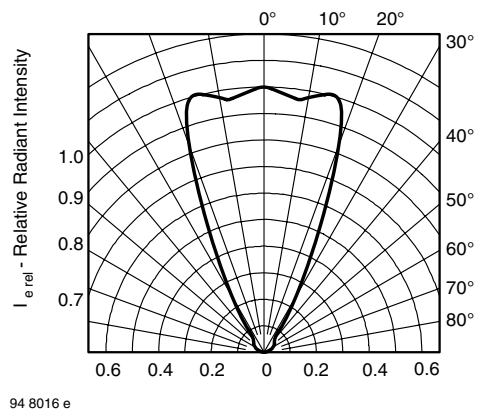

Fig. 10 - Relative Radiant Intensity vs. Angular Displacement

TSHA5500, TSHA5501, TSHA5502, TSHA5503

Vishay Semiconductors

Infrared Emitting Diode, RoHS Compliant,
875 nm, GaAlAs



PACKAGE DIMENSIONS in millimeters

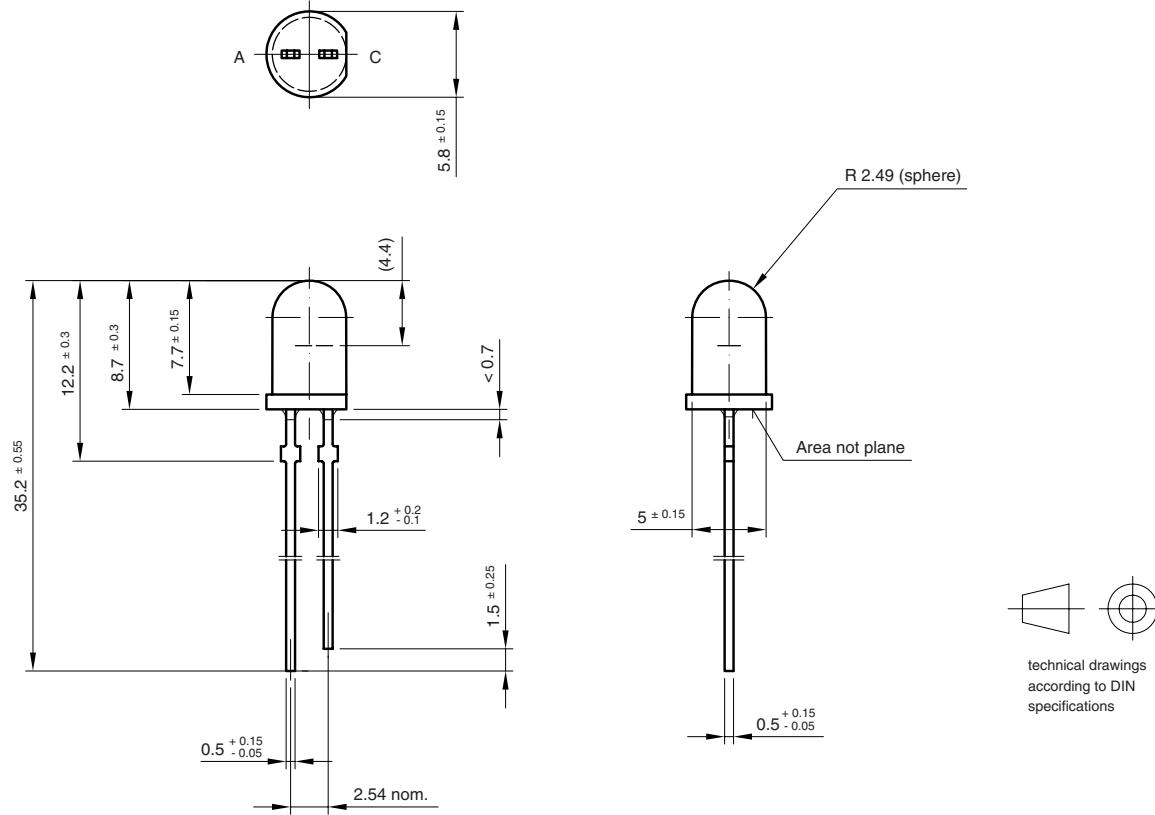

6.544-5258.08-4
Issue: 3; 08.11.99
14435



Disclaimer

All product specifications and data are subject to change without notice.

Vishay Intertechnology, Inc., its affiliates, agents, and employees, and all persons acting on its or their behalf (collectively, "Vishay"), disclaim any and all liability for any errors, inaccuracies or incompleteness contained herein or in any other disclosure relating to any product.

Vishay disclaims any and all liability arising out of the use or application of any product described herein or of any information provided herein to the maximum extent permitted by law. The product specifications do not expand or otherwise modify Vishay's terms and conditions of purchase, including but not limited to the warranty expressed therein, which apply to these products.

No license, express or implied, by estoppel or otherwise, to any intellectual property rights is granted by this document or by any conduct of Vishay.

The products shown herein are not designed for use in medical, life-saving, or life-sustaining applications unless otherwise expressly indicated. Customers using or selling Vishay products not expressly indicated for use in such applications do so entirely at their own risk and agree to fully indemnify Vishay for any damages arising or resulting from such use or sale. Please contact authorized Vishay personnel to obtain written terms and conditions regarding products designed for such applications.

Product names and markings noted herein may be trademarks of their respective owners.