

## High Speed Infrared Emitting Diode in T-1<sup>3</sup>/<sub>4</sub> Package

### Description

TSHF5210 is a high speed infrared emitting diode in GaAlAs double hetero (DH) technology, molded in a clear, untinted plastic package.

TSHF5210 combines high speed with high radiant power at wavelength of 890 nm.

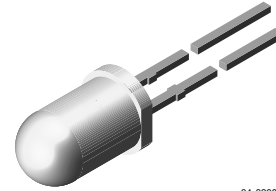

94 8390

### Features

- High modulation bandwidth
- Extra high radiant power and radiant intensity
- Low forward voltage
- Suitable for high pulse current operation
- Standard package T-1<sup>3</sup>/<sub>4</sub> (∅ 5 mm)
- Angle of half intensity  $\varphi = \pm 10^\circ$
- Peak wavelength  $\lambda_p = 890 \text{ nm}$
- High reliability
- Good spectral matching to Si photodetectors
- Lead (Pb)-free component
- Component in accordance with RoHS 2002/95/EC and WEEE 2002/96/EC



### Applications

Infrared high speed remote control and free air data transmission systems with high modulation frequencies or high data transmission rate requirements.

TSHF5210 is ideal for the design of transmission systems according to IrDA requirements and for carrier frequency based systems (e.g. ASK / FSK - coded, 450 kHz or 1.3 MHz).

### Parts Table

Part	Remarks
TSHF5210	MOQ: 4000 pcs

### Absolute Maximum Ratings

$T_{amb} = 25^\circ\text{C}$ , unless otherwise specified

Parameter	Test condition	Symbol	Value	Unit
Reverse Voltage		$V_R$	5	V
Forward Current		$I_F$	100	mA
Peak Forward Current	$t_p/T = 0.5$ , $t_p = 100 \mu\text{s}$	$I_{FM}$	200	mA
Surge Forward Current	$t_p = 100 \mu\text{s}$	$I_{FSM}$	1.5	A
Power Dissipation		$P_V$	180	mW
Junction Temperature		$T_j$	100	$^\circ\text{C}$
Operating Temperature Range		$T_{amb}$	- 40 to + 85	$^\circ\text{C}$
Storage Temperature Range		$T_{stg}$	- 40 to + 100	$^\circ\text{C}$
Soldering Temperature	$t \leq 5 \text{ sec}$ , 2 mm from case	$T_{sd}$	260	$^\circ\text{C}$
Thermal Resistance Junction/Ambient		$R_{thJA}$	270	K/W

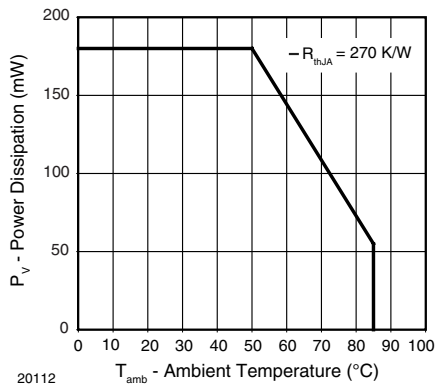

Figure 1. Power Dissipation Limit vs. Ambient Temperature

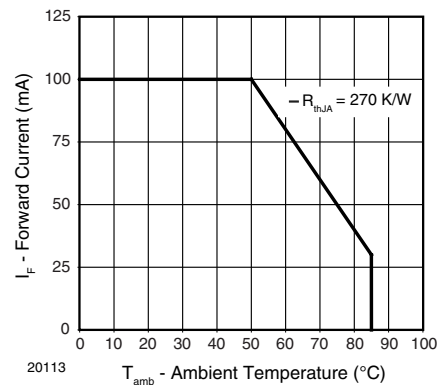

Figure 2. Forward Current Limit vs. Ambient Temperature

## Basic Characteristics

$T_{amb} = 25\text{ }^{\circ}\text{C}$ , unless otherwise specified

Parameter	Test condition	Symbol	Min	Typ.	Max	Unit
Forward Voltage	$I_F = 100\text{ mA}$ , $t_p = 20\text{ ms}$	$V_F$		1.4	1.6	V
	$I_F = 1\text{ A}$ , $t_p = 100\text{ }\mu\text{s}$	$V_F$		2.3		V
Temp. Coefficient of $V_F$	$I_F = 100\text{ mA}$	$TK_{V_F}$		-2.1		mV/K
Reverse Current	$V_R = 5\text{ V}$	$I_R$			10	$\mu\text{A}$
Junction Capacitance	$V_R = 0\text{ V}$ , $f = 1\text{ MHz}$ , $E = 0$	$C_j$		125		pF
Radiant Intensity	$I_F = 100\text{ mA}$ , $t_p = 20\text{ ms}$	$I_e$	68	140	340	mW/sr
	$I_F = 1\text{ A}$ , $t_p = 100\text{ }\mu\text{s}$	$I_e$		1400		mW/sr
Radiant Power	$I_F = 100\text{ mA}$ , $t_p = 20\text{ ms}$	$\phi_e$		48		mW
Temp. Coefficient of $\phi_e$	$I_F = 100\text{ mA}$	$TK_{\phi_e}$		-0.35		%/K
Angle of Half Intensity		$\phi$		$\pm 10$		deg
Peak Wavelength	$I_F = 100\text{ mA}$	$\lambda_p$		890		nm
Spectral Bandwidth	$I_F = 100\text{ mA}$	$\Delta\lambda$		40		nm
Temp. Coefficient of $\lambda_p$	$I_F = 100\text{ mA}$	$TK_{\lambda_p}$		0.25		nm/K
Rise Time	$I_F = 100\text{ mA}$	$t_r$		30		ns
Fall Time	$I_F = 100\text{ mA}$	$t_f$		30		ns
Cut-Off Frequency	$I_{DC} = 70\text{ mA}$ , $I_{AC} = 30\text{ mA pp}$	$f_c$		12		MHz
Virtual Source Diameter		$\emptyset$		3.7		mm

## Typical Characteristics

$T_{amb} = 25\text{ }^{\circ}\text{C}$  unless otherwise specified

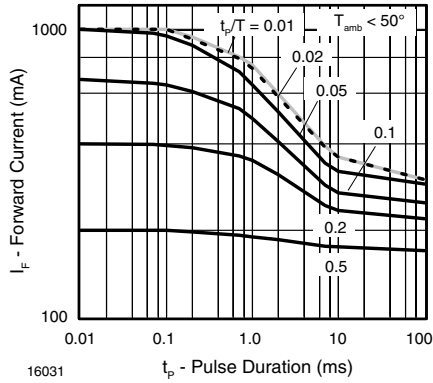

Figure 3. Pulse Forward Current vs. Pulse Duration

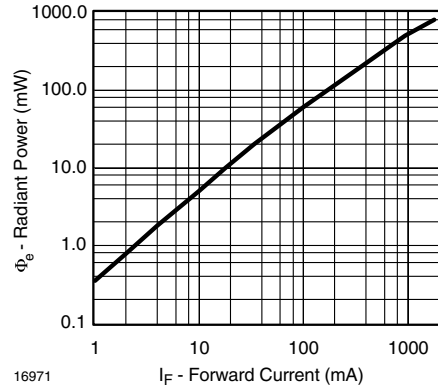

Figure 6. Radiant Power vs. Forward Current

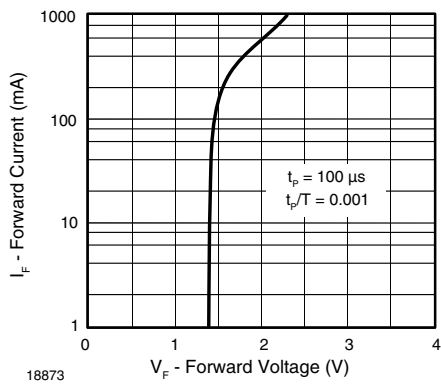

Figure 4. Forward Current vs. Forward Voltage

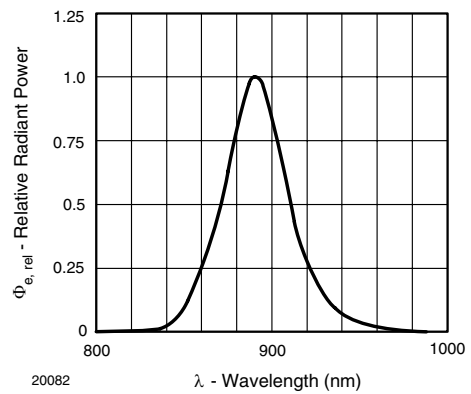

Figure 7. Relative Radiant Power vs. Wavelength

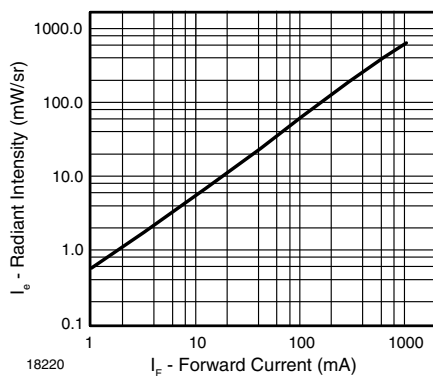

Figure 5. Radiant Intensity vs. Forward Current

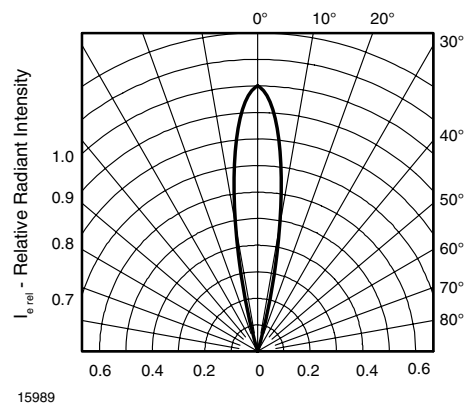
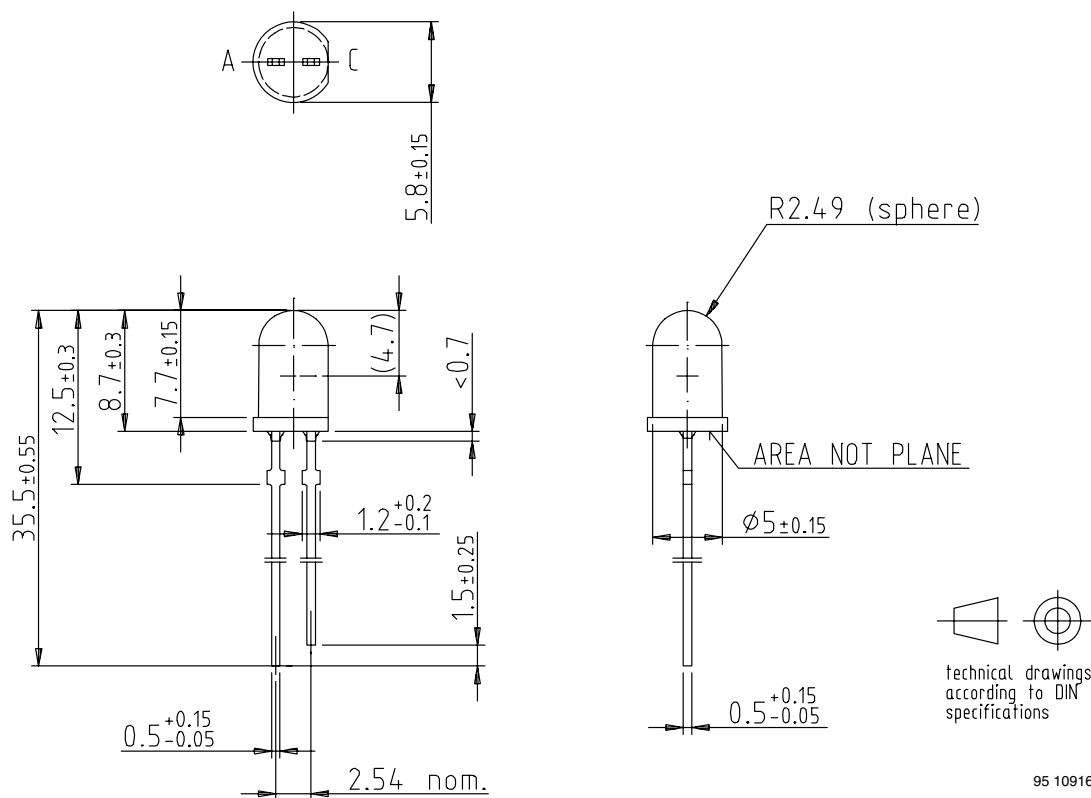

Figure 8. Relative Radiant Intensity vs. Angular Displacement

## Package Dimensions in mm



**Ozone Depleting Substances Policy Statement**

It is the policy of Vishay Semiconductor GmbH to

1. Meet all present and future national and international statutory requirements.
2. Regularly and continuously improve the performance of our products, processes, distribution and operating systems with respect to their impact on the health and safety of our employees and the public, as well as their impact on the environment.

It is particular concern to control or eliminate releases of those substances into the atmosphere which are known as ozone depleting substances (ODSs).

The Montreal Protocol (1987) and its London Amendments (1990) intend to severely restrict the use of ODSs and forbid their use within the next ten years. Various national and international initiatives are pressing for an earlier ban on these substances.

Vishay Semiconductor GmbH has been able to use its policy of continuous improvements to eliminate the use of ODSs listed in the following documents.

1. Annex A, B and list of transitional substances of the Montreal Protocol and the London Amendments respectively
2. Class I and II ozone depleting substances in the Clean Air Act Amendments of 1990 by the Environmental Protection Agency (EPA) in the USA
3. Council Decision 88/540/EEC and 91/690/EEC Annex A, B and C (transitional substances) respectively.

Vishay Semiconductor GmbH can certify that our semiconductors are not manufactured with ozone depleting substances and do not contain such substances.

We reserve the right to make changes to improve technical design  
and may do so without further notice.

Parameters can vary in different applications. All operating parameters must be validated for each customer application by the customer. Should the buyer use Vishay Semiconductors products for any unintended or unauthorized application, the buyer shall indemnify Vishay Semiconductors against all claims, costs, damages, and expenses, arising out of, directly or indirectly, any claim of personal damage, injury or death associated with such unintended or unauthorized use.

Vishay Semiconductor GmbH, P.O.B. 3535, D-74025 Heilbronn, Germany



### Notice

Specifications of the products displayed herein are subject to change without notice. Vishay Intertechnology, Inc., or anyone on its behalf, assumes no responsibility or liability for any errors or inaccuracies.

Information contained herein is intended to provide a product description only. No license, express or implied, by estoppel or otherwise, to any intellectual property rights is granted by this document. Except as provided in Vishay's terms and conditions of sale for such products, Vishay assumes no liability whatsoever, and disclaims any express or implied warranty, relating to sale and/or use of Vishay products including liability or warranties relating to fitness for a particular purpose, merchantability, or infringement of any patent, copyright, or other intellectual property right.

The products shown herein are not designed for use in medical, life-saving, or life-sustaining applications. Customers using or selling these products for use in such applications do so at their own risk and agree to fully indemnify Vishay for any damages resulting from such improper use or sale.