

## GaAs Infrared Emitting Diode in Side View Package

### Description

TSKS5400 is a standard GaAs infrared emitting diode in a flat sideview molded plastic package. A small recessed spherical lens provides an improved radiant intensity in a low profile case.

The diode is case compatible to the TEKS5400 photodetector, allowing the user to assemble his own optical sensor.

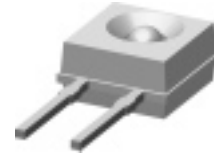

14 354

### Features

- Side view package with spherical lens
- Radiation direction perpendicular to mounting direction
- Angle of half sensitivity  $\varphi = \pm 30^\circ$
- Peak wavelength  $\lambda_p = 950 \text{ nm}$
- Case compatible with TEKS5400
- Ordering code:  
TSKS5400-ESZ (2.54 mm Pin distance)

### Absolute Maximum Ratings

 $T_{\text{amb}} = 25^\circ\text{C}$ 

Parameter	Test Conditions	Symbol	Value	Unit
Reverse voltage		$V_R$	6	V
Forward current		$I_F$	100	mA
Surge forward current	$t_p \leq 100 \mu\text{s}$	$I_{FSM}$	2	A
Power dissipation		$P_V$	170	mW
Junction temperature		$T_j$	100	$^\circ\text{C}$
Operating temperature range		$T_{stg}$	-25 to +85	$^\circ\text{C}$
Storage temperature range		$T_{stg}$	-40 to +100	$^\circ\text{C}$
Soldering temperature	$t \leq 5 \text{ s}, 2 \text{ mm from body}$	$T_{sd}$	260	$^\circ\text{C}$
Thermal resistance junction/ ambient		$R_{thJA}$	450	k/W

### Basic Characteristics

$T_{amb} = 25^{\circ}\text{C}$

Parameter	Test Conditions	Symbol	Min	Typ	Max	Unit
Forward voltage	$I_F = 100\text{ mA}$ , $t_p \leq 20\text{ ms}$	$V_F$		1.3	1.7	V
Reverse voltage	$I_R = 10\text{ }\mu\text{A}$	$V_{VR}$	6			V
Junction capacitance	$V_R = 0\text{ V}$ , $f = 1\text{ MHz}$ , $E = 0$	$C_j$		50		pF
Radiant intensity	$I_F = 50\text{ mA}$ , $t_p \leq 20\text{ ms}$	$I_e$	2		7	mW/ sr
Radiant power	$I_F = 50\text{ mA}$ , $t_p \leq 20\text{ ms}$	$\phi_e$		10		mW
Temp. coefficient of $\phi_e$	$I_F = 50\text{ mA}$	$TK_{\phi_e}$		-1		% K
Angle of half sensitivity		$\phi$		$\pm 30$		$^{\circ}$
Peak wavelength	$I_F = 50\text{ mA}$	$\lambda_p$		950		nm
Spectral bandwidth	$I_F = 50\text{ mA}$	$\Delta\lambda$		50		nm
Rise time	$I_F = 1\text{ A}$ , $t_p/T = 0.01$ , $t_p \leq 10\text{ }\mu\text{s}$	$t_r$		400		ns
Fall time	$I_F = 1\text{ A}$ , $t_p/T = 0.01$ , $t_p \leq 10\text{ }\mu\text{s}$	$t_f$		450		ns

### Typical Characteristics ( $T_{amb} = 25^{\circ}\text{C}$ unless otherwise specified)

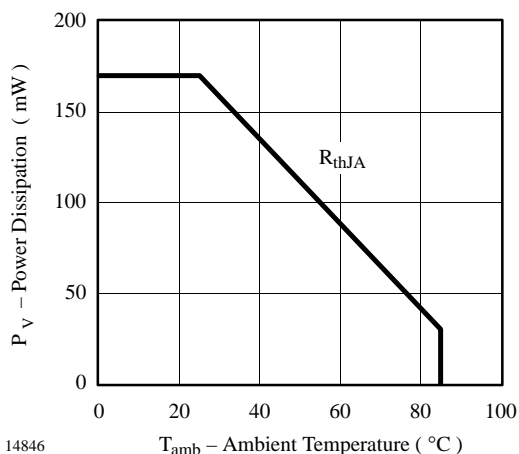

Figure 1. Power Dissipation vs. Ambient Temperature

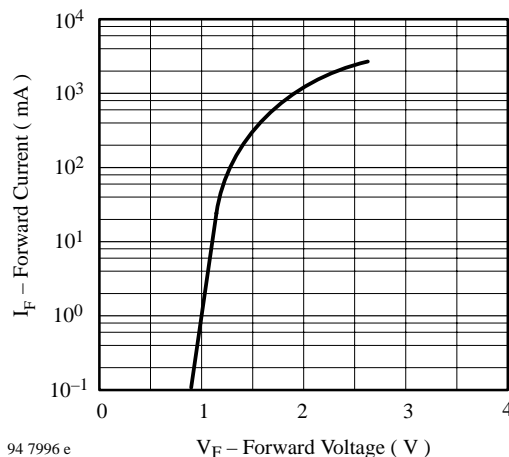

Figure 3. Forward Current vs. Forward Voltage

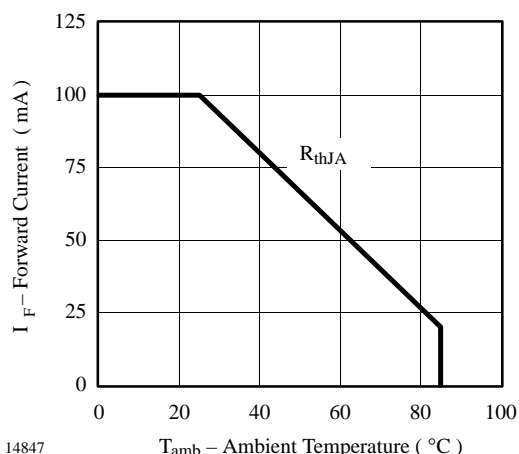

Figure 2. Forward Current vs. Ambient Temperature

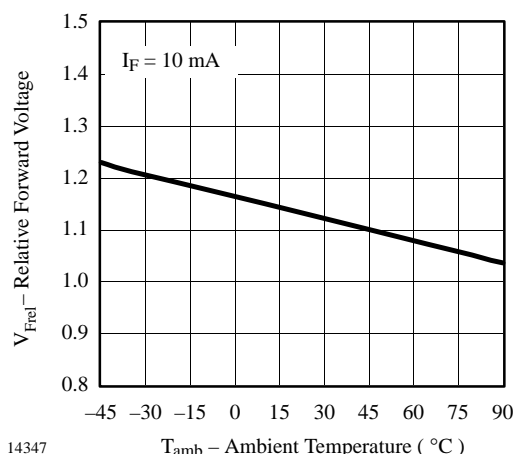

Figure 4. Relative Forward Current vs. Ambient Temperature

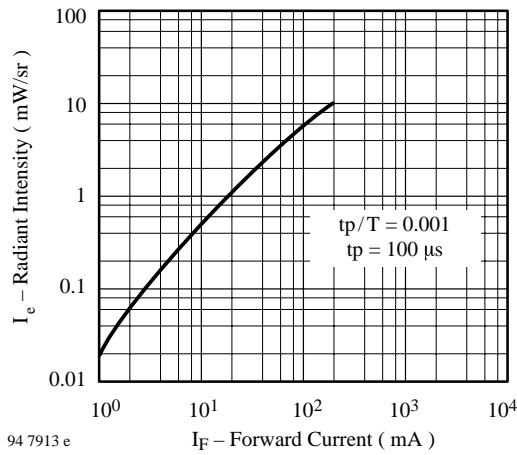

Figure 5. Radiant Intensity vs. Forward Current

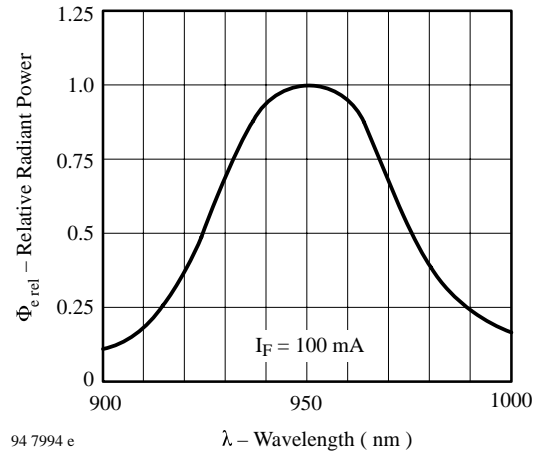

Figure 8. Relative Radiant Power vs. Wavelength

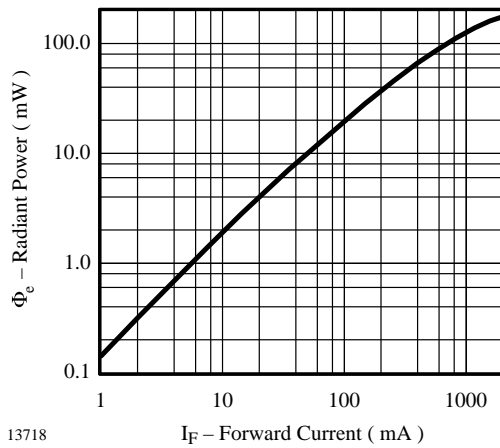

Figure 6. Radiant Power vs. Forward Current

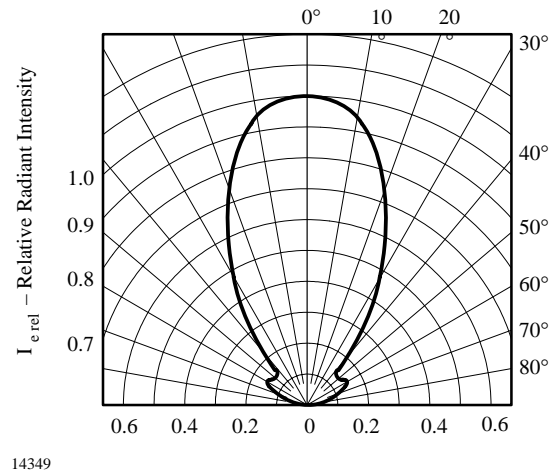

Figure 9. Relative Radiant Intensity vs. Angular Displacement

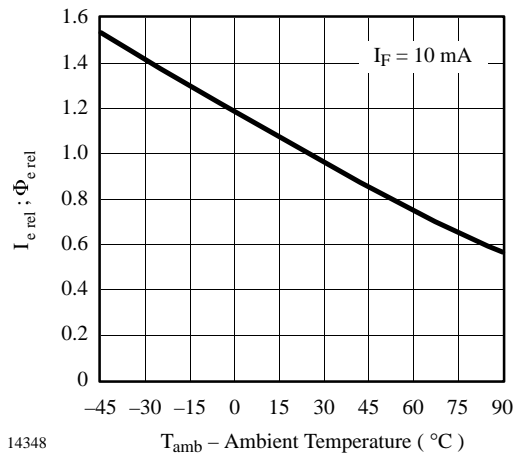
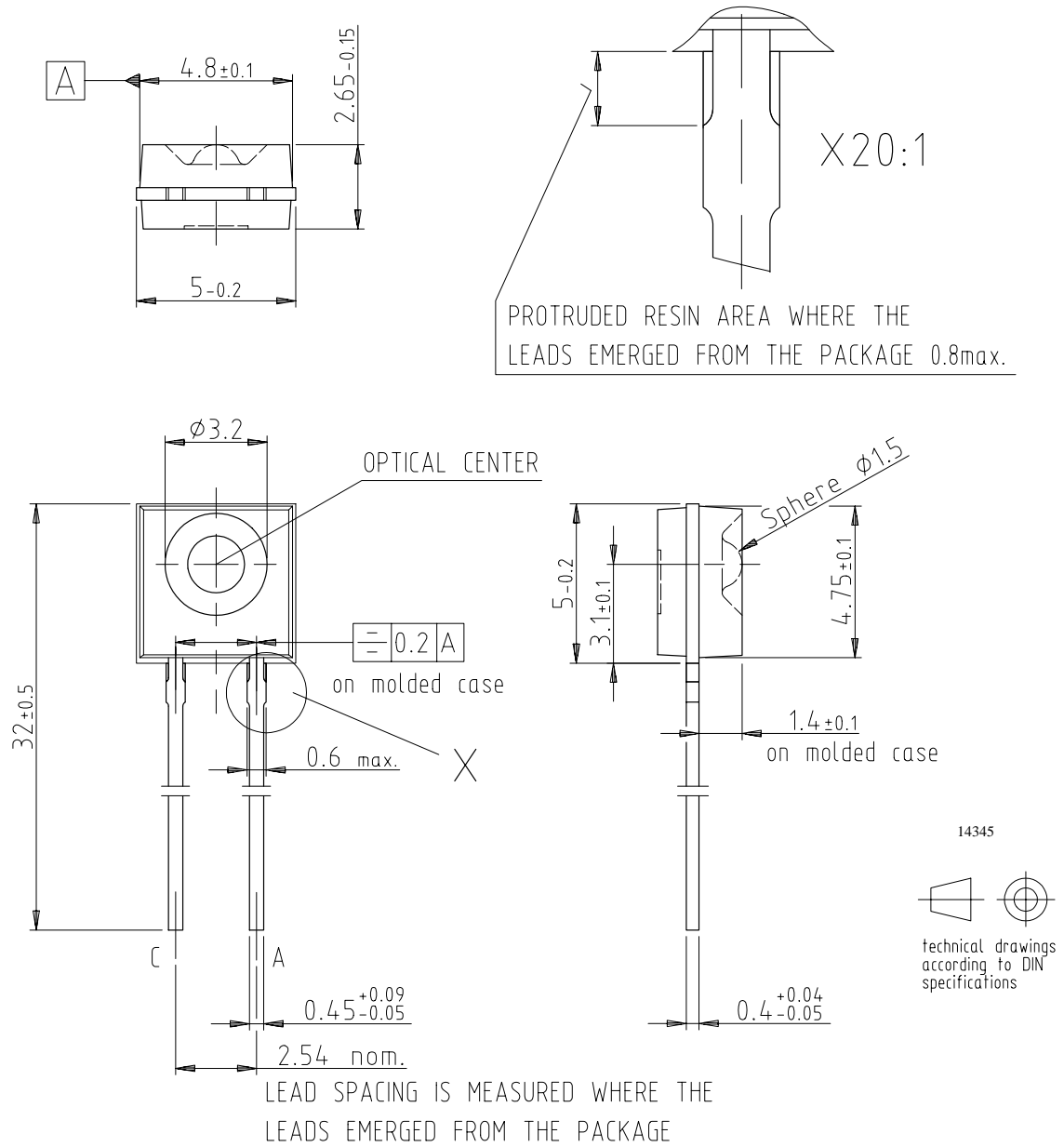

Figure 7. Relative Radiant Intensity vs. Ambient Temperature

## Dimensions of TSKS5400 in mm





## **Ozone Depleting Substances Policy Statement**

It is the policy of **Vishay Semiconductor GmbH** to

1. Meet all present and future national and international statutory requirements.
2. Regularly and continuously improve the performance of our products, processes, distribution and operating systems with respect to their impact on the health and safety of our employees and the public, as well as their impact on the environment.

It is particular concern to control or eliminate releases of those substances into the atmosphere which are known as ozone depleting substances (ODSs).

The Montreal Protocol (1987) and its London Amendments (1990) intend to severely restrict the use of ODSs and forbid their use within the next ten years. Various national and international initiatives are pressing for an earlier ban on these substances.

**Vishay Semiconductor GmbH** has been able to use its policy of continuous improvements to eliminate the use of ODSs listed in the following documents.

1. Annex A, B and list of transitional substances of the Montreal Protocol and the London Amendments respectively
2. Class I and II ozone depleting substances in the Clean Air Act Amendments of 1990 by the Environmental Protection Agency (EPA) in the USA
3. Council Decision 88/540/EEC and 91/690/EEC Annex A, B and C (transitional substances) respectively.

**Vishay Semiconductor GmbH** can certify that our semiconductors are not manufactured with ozone depleting substances and do not contain such substances.

**We reserve the right to make changes to improve technical design and may do so without further notice.**

Parameters can vary in different applications. All operating parameters must be validated for each customer application by the customer. Should the buyer use Vishay-Telefunken products for any unintended or unauthorized application, the buyer shall indemnify Vishay-Telefunken against all claims, costs, damages, and expenses, arising out of, directly or indirectly, any claim of personal damage, injury or death associated with such unintended or unauthorized use.

Vishay Semiconductor GmbH, P.O.B. 3535, D-74025 Heilbronn, Germany  
Telephone: 49 (0)7131 67 2831, Fax number: 49 (0)7131 67 2423