

20 + 1 channel buffer for TFT-LCD panels

Features

- Wide supply voltage: 5.5V to 16.8V
- Low operating current: 8.5mA typ. at 25°C
- Bandwidth at -3dB: 5MHz
- High output current COM amplifier: $\pm 150\text{mA}$
- Industrial temperature range: -40°C to +95°C
- Small package: TQFP48 ePad

Application

- TFT liquid crystal display (LCD)

Description

The TSL1020 is composed of 20 + 1 channel buffers which are used to buffer the reference voltage for gamma correction in thin film transistor (TFT) liquid crystal displays (LCD).

One COM amplifier is able to deliver high output current, up to $\pm 150\text{mA}$. Amplifiers A and B feature positive single supply inputs for common mode voltage, thus can be used for the highest gamma voltages. The amplifiers C to T inclusive, and the COM amplifier, feature negative single supply inputs and are dedicated to the lowest gamma voltages.

The TSL1020 is fully characterized and guaranteed over a wide industrial temperature range (-40 to +95°C).

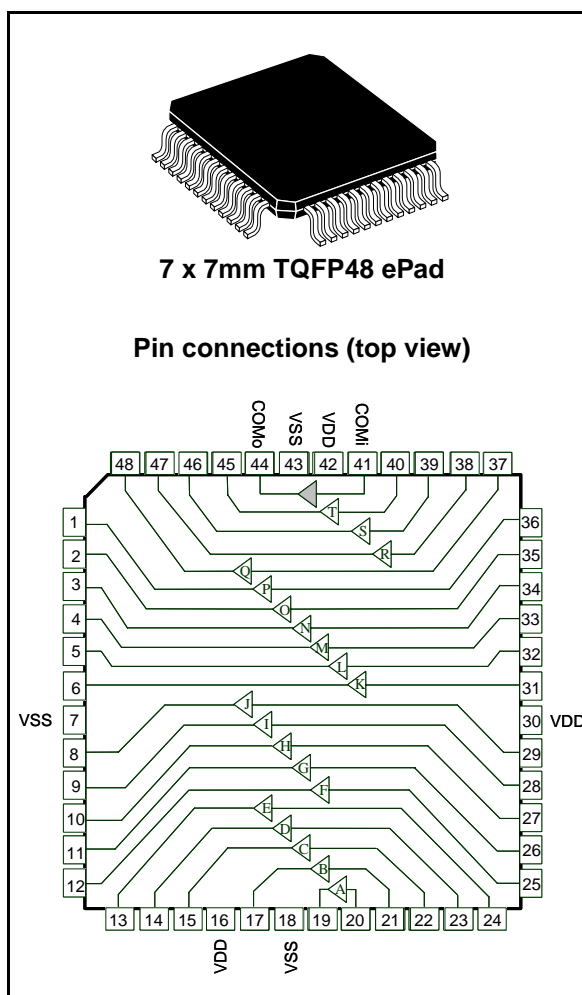

1 Absolute maximum ratings and operating conditions

Table 1. Absolute maximum ratings

| Symbol | Parameter | Value | Unit |
|------------|------------------------------------------------------------------------------------------|----------------------------------|------|
| V_{CC} | Supply voltage ($V_{DD} - V_{SS}$) | 18 | V |
| V_{in} | Input voltage | $V_{SS} - 0.5$ to $V_{DD} + 0.5$ | V |
| R_{thja} | Thermal resistance junction to ambient for TQFP48 ePad not thermally connected to PCB | 85 | °C/W |
| | ePad thermally connected to PCB | 36 | |
| T_{lead} | Lead temperature (soldering 10 seconds) | 260 | °C |
| T_{stg} | Storage temperature | -65 to +150 | °C |
| T_j | Junction temperature | 150 | °C |
| ESD | Human body model (HBM) ⁽¹⁾ | 2000 | V |
| | Machine model (MM) ⁽²⁾ | 200 | V |

- Human body model: A 100pF capacitor is charged to the specified voltage, then discharged through a 1.5kΩ resistor between two pins of the device. This is done for all couples of connected pin combinations while the other pins are floating.
- Machine model: A 200pF capacitor is charged to the specified voltage, then discharged directly between two pins of the device with no external series resistor (internal resistor < 5Ω). This is done for all couples of connected pin combinations while the other pins are floating.

Table 2. Operating conditions

| Symbol | Parameter | Value | Unit |
|-----------|-----------------------------------------|-----------------------------|------|
| V_{CC} | Supply voltage ($V_{DD} - V_{SS}$) | 5.5 to 16.8 | V |
| T_{amb} | Ambient temperature | -40 to +95 | °C |
| V_{in} | Input voltages for buffers A & B | $V_{SS} + 1.5V$ to V_{DD} | V |
| | Input voltages for buffers C to T & COM | V_{SS} to $V_{DD} - 1.5V$ | |

2 Typical application schematics

Figure 1. A typical application schematic for the TSL1020

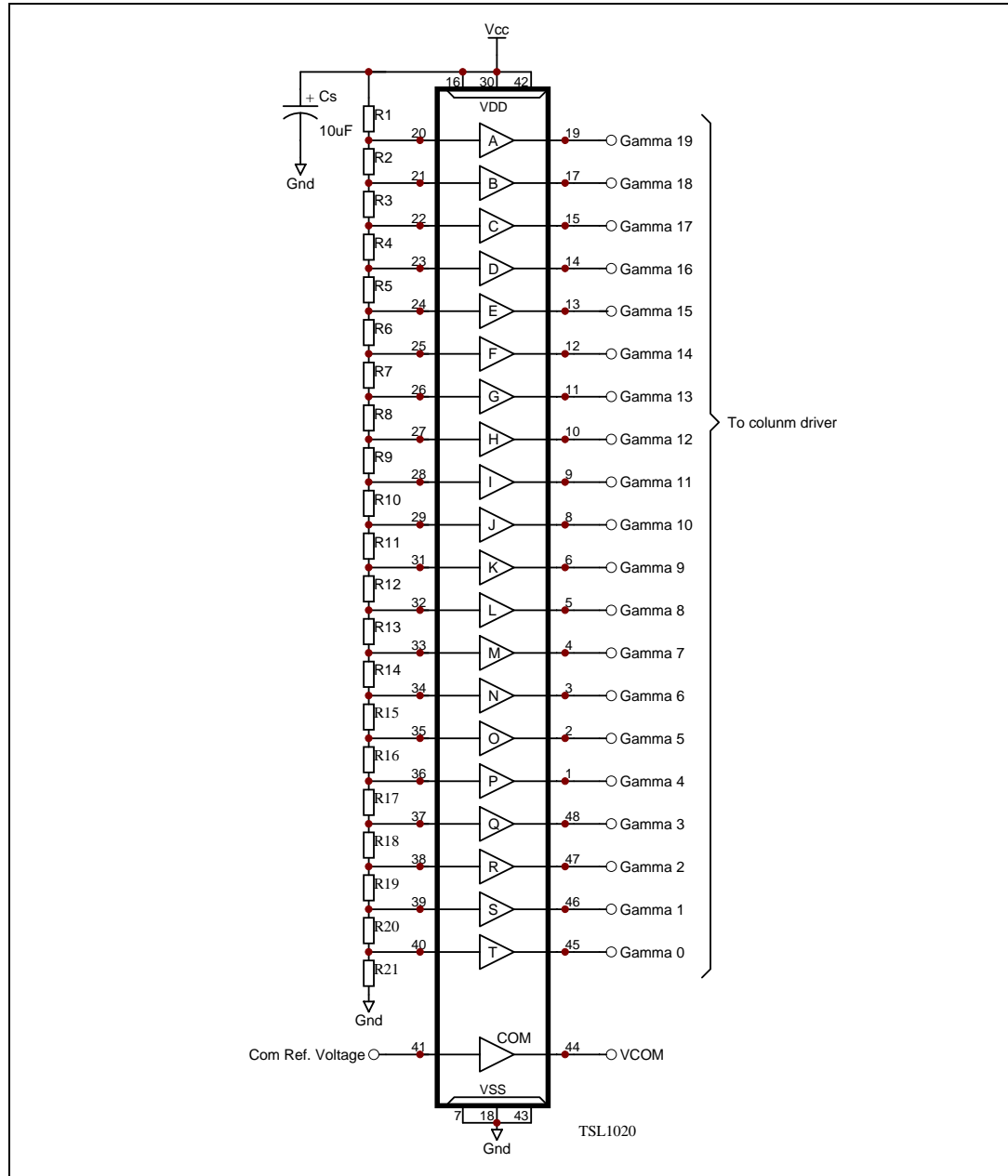

Note that:

- Amplifiers **A & B** have their input voltages in the range $V_{SS}+1.5V$ to V_{DD} . This is why they must be used for high level gamma correction voltages.
- Amplifiers **C to T** have their input voltages in the range V_{SS} to $V_{DD}-1.5V$. This is why they must be used for medium-to-low level gamma correction voltages.
- Amplifier **COM** has its input voltage range from V_{SS} to $V_{DD}-1.5V$.

3 Electrical characteristics

Table 3. Electrical characteristics for $T_{amb} = 25^{\circ}\text{C}$, $V_{DD} = +5\text{V}$, $V_{SS} = -5\text{V}$, $R_L = 10\text{k}\Omega$, $C_L = 10\text{pF}$ (unless otherwise specified)

| Symbol | Parameter | Test conditions | Min. | Typ. | Max. | Unit |
|-----------------|--------------------------------------|---------------------------------------------------------------------------------------|------|----------------|----------------|--------------------------------|
| V_{io} | Input offset voltage | $V_{icm} = 0\text{V}$ | | | 12 | mV |
| ΔV_{io} | Input offset voltage drift | $-40^{\circ}\text{C} < T_{amb} < +95^{\circ}\text{C}$ | | 5 | | $\mu\text{V}/^{\circ}\text{C}$ |
| I_{ib} | Input bias current | $V_{icm} = 0\text{V}$, buffers A & B $V_{icm} = 0\text{V}$, buffers C to T & COM | | | 140 70 | nA |
| R_{in} | Input impedance | | | 1 | | G Ω |
| C_{in} | Input capacitance | | | 1.35 | | pF |
| V_{OL} | Output voltage low | $I_{out} = -5\text{mA}$ Buffers C to R Buffers S, T & COM | | -4.88 -4.92 | -4.80 -4.85 | V |
| V_{OH} | Output voltage high | $I_{out} = 5\text{mA}$ for buffers A & B | 4.82 | 4.87 | | V |
| I_{out} | Short circuit output current | (A to T buffers) | | ± 40 | | mA |
| | | COM buffer | | ± 150 | | |
| PSRR | Power supply rejection ratio | $V_{CC} = 6.5$ to 15.5V | 80 | 100 | | dB |
| I_{CC} | Supply current | No load | | 8.5 | 12 | mA |
| SR | Slew rate (rising & falling edge) | $-3.5\text{V} < V_{out} < +3.5\text{V}$ 10% to 90% | | 1.1 | | V/ μs |
| t_s | Settling time | Settling to 0.1%, $V_{out} = 2\text{V}$ step | | 5 | | μs |
| BW | Bandwidth at -3dB | $R_L = 10\text{k}\Omega$, $C_L = 10\text{pF}$ | | 5 | | MHz |
| G_m | Phase margin | $R_L = 10\text{k}\Omega$, $C_L = 10\text{pF}$ | | 70 | | degrees |
| C_s | Channel separation | $f = 1\text{MHz}$ | | 75 | | dB |

Note: Limits are 100% production tested at 25°C. Behavior at the temperature range limits is guaranteed through correlation and by design.

Figure 2. Supply current vs. supply voltage for various temperatures

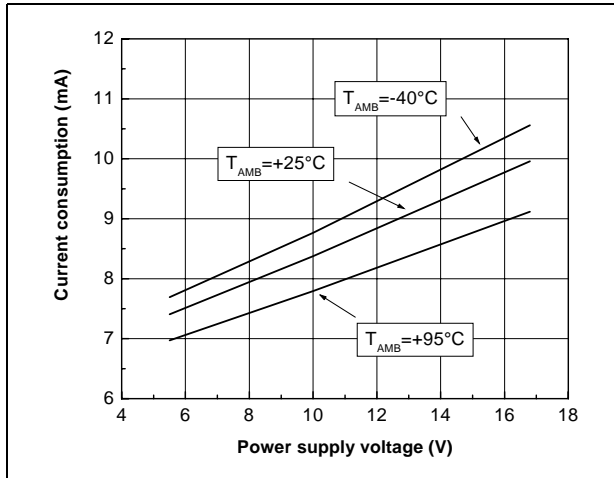

Figure 3. Output offset voltage (eq. V_{io}) vs. temperature

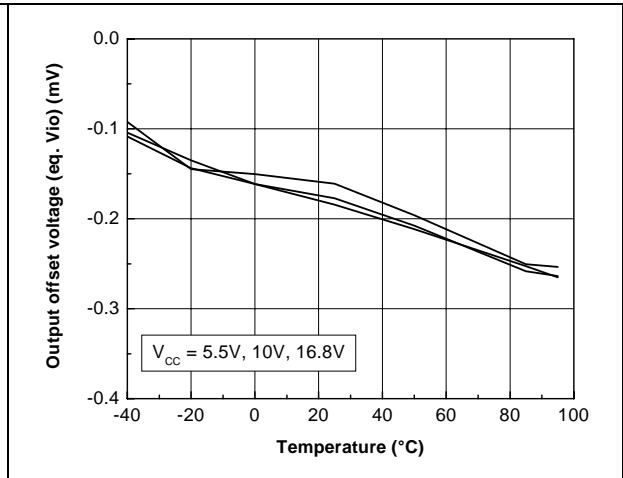

Figure 4. Input current (I_{ib}) vs. temperature

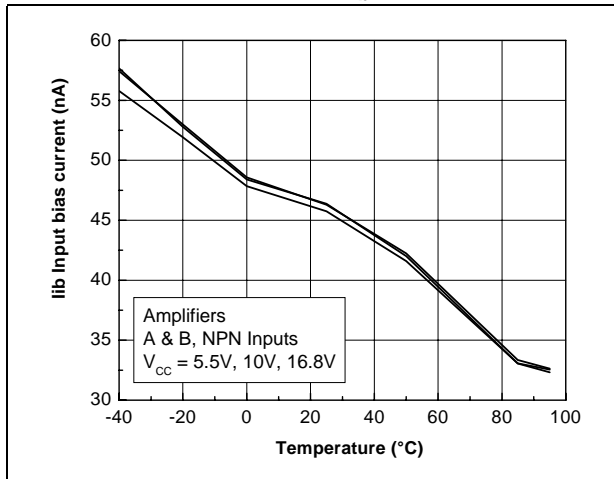

Figure 5. Input current (I_{ib}) vs. temperature

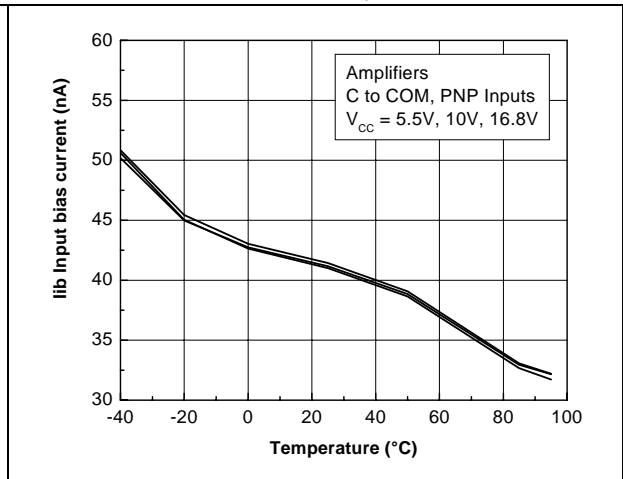

Figure 6. Output current capability vs. temperature

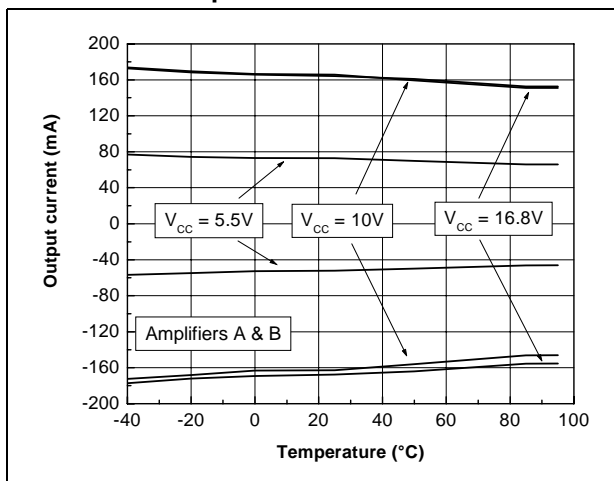

Figure 7. Output current capability vs. temperature

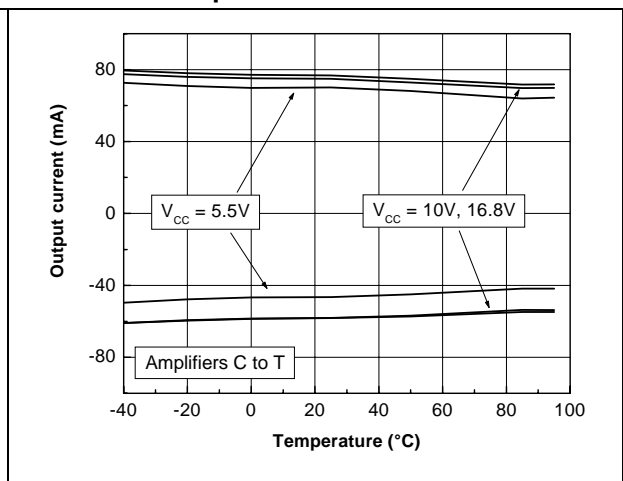

Figure 8. Output current capability vs. temperature

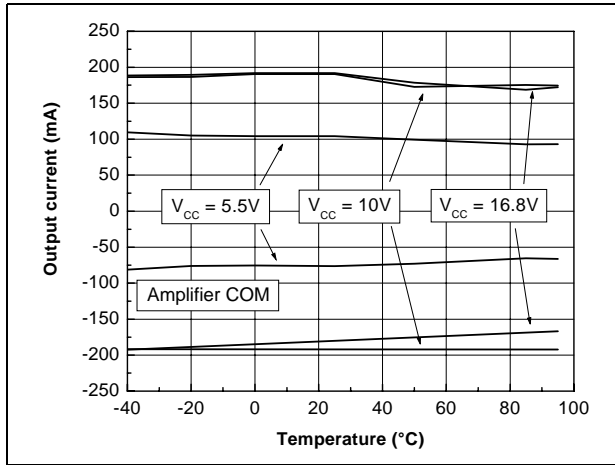

Figure 9. High level voltage drop vs. temperature

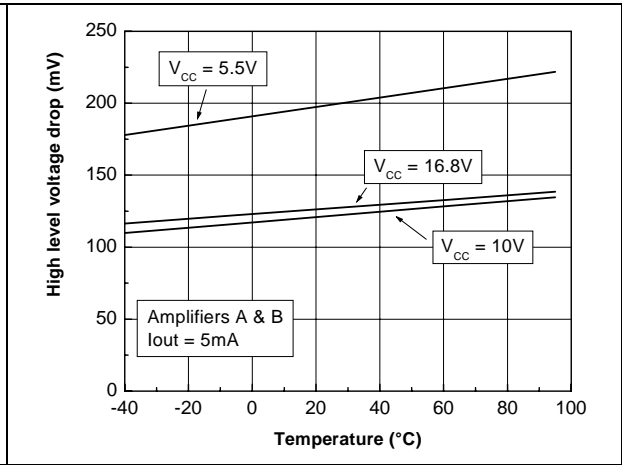

Figure 10. Low level voltage drop vs. temperature

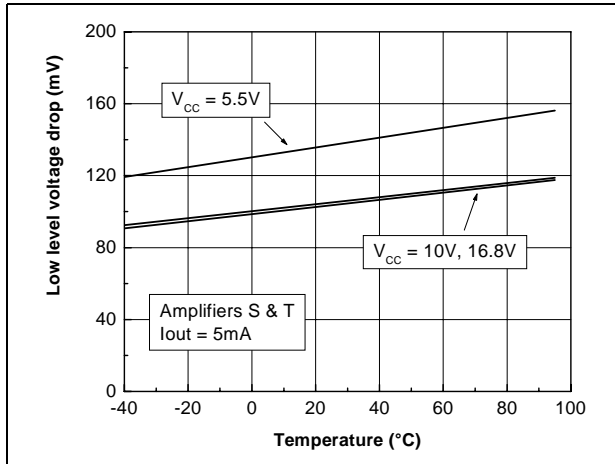

Figure 11. Low level voltage drop vs. temperature

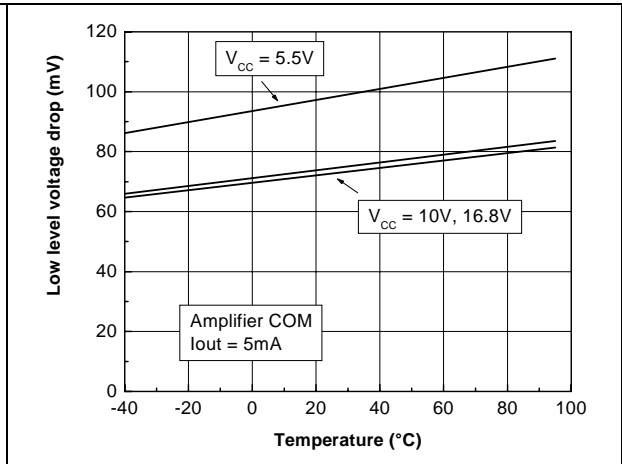

Figure 12. Voltage output high (V_{OH}) vs. output current - Amplifiers A & B

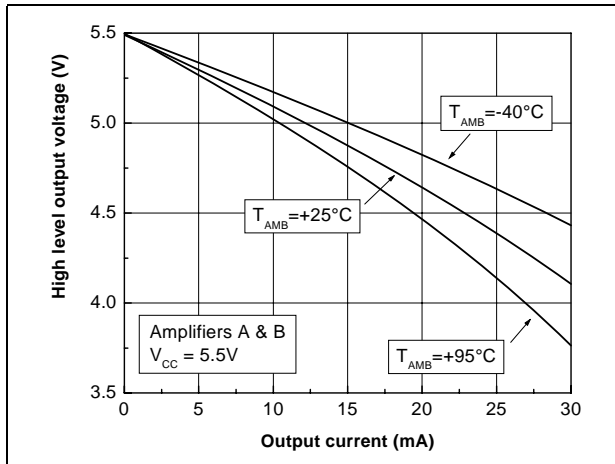

Figure 13. Voltage output high (V_{OH}) vs. output current - Amplifiers A & B

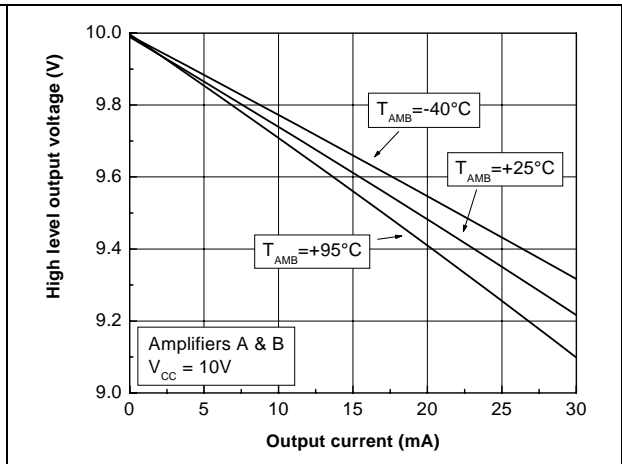

Figure 14. Voltage output high (V_{OH}) vs. output current - Amplifiers A & B

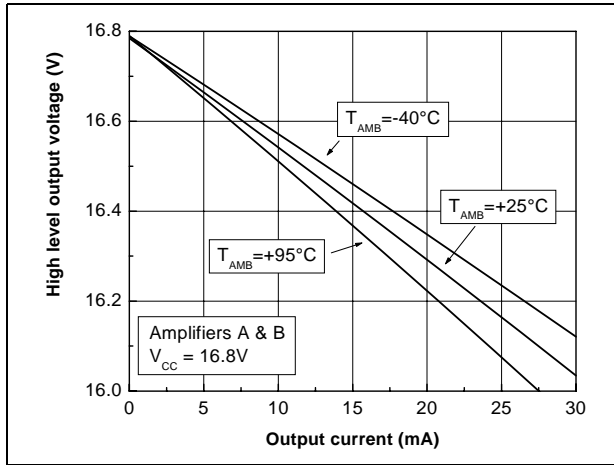

Figure 15. Voltage output low (V_{OL}) vs. output current - Amplifiers C to R

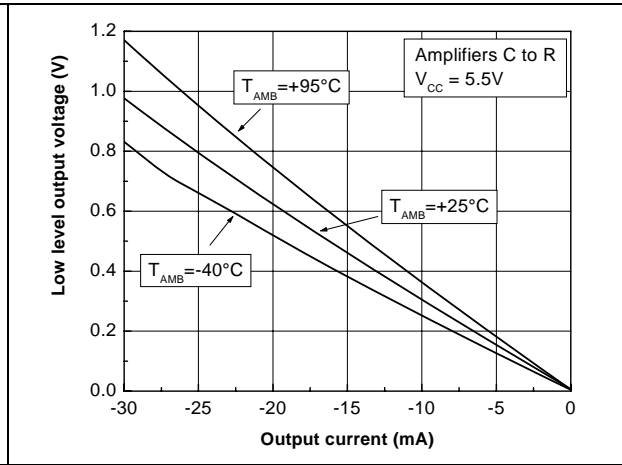

Figure 16. Voltage output low (V_{OL}) vs. output current - Amplifiers C to R

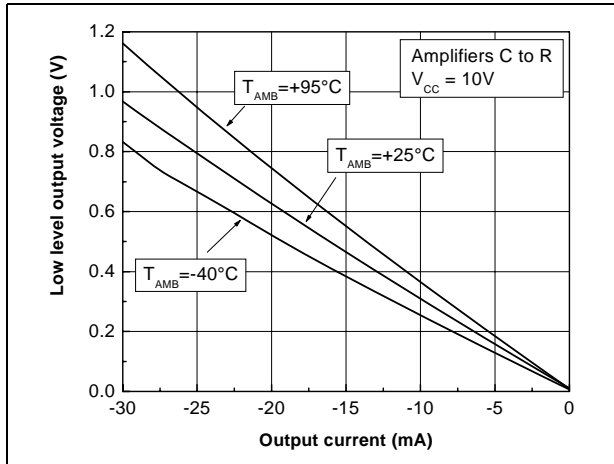

Figure 17. Voltage output low (V_{OL}) vs. output current - Amplifiers C to R

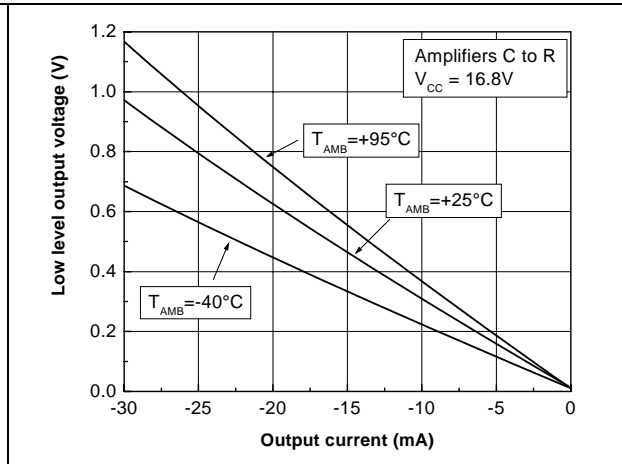

Figure 18. Voltage output low (V_{OL}) vs. output current - Amplifiers S & T

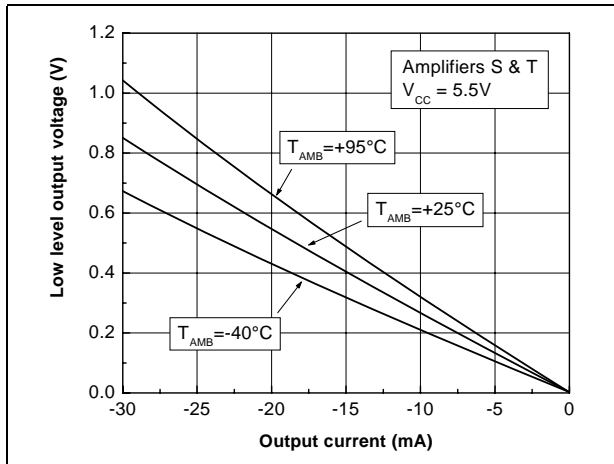

Figure 19. Voltage output low (V_{OL}) vs. output current - Amplifiers S & T

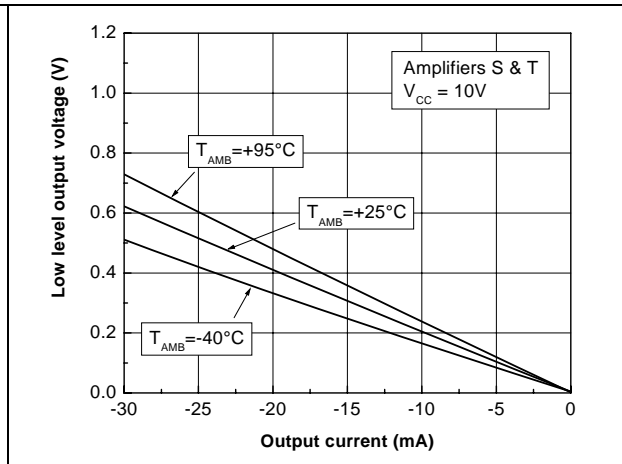

Figure 20. Voltage output low (V_{OL}) vs. output current - Amplifiers S & T

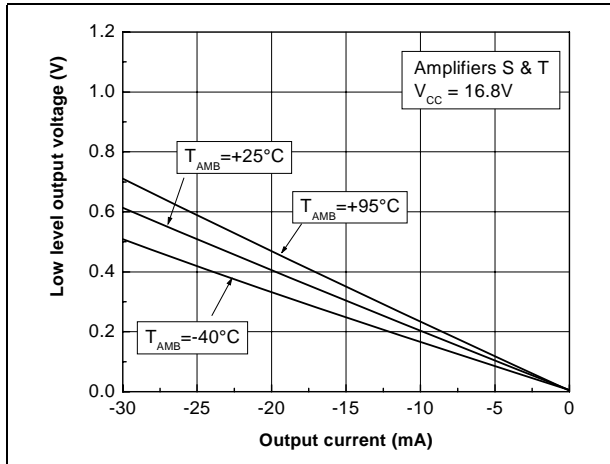

Figure 21. Voltage output low (V_{OL}) vs. output current - Amplifier COM

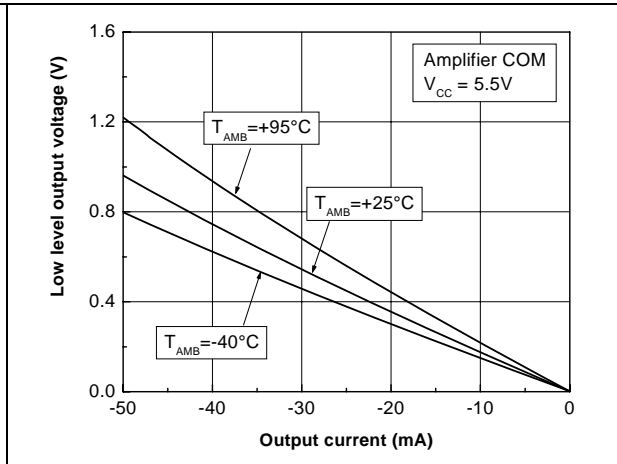

Figure 22. Voltage output low (V_{OL}) vs. output current - Amplifier COM

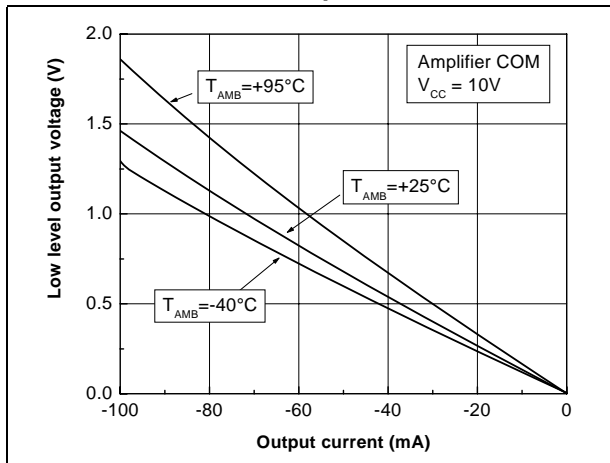

Figure 23. Voltage output low (V_{OL}) vs. output current - Amplifier COM

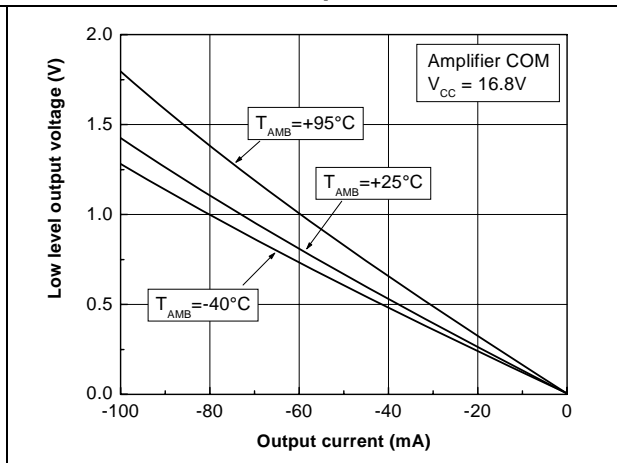

Figure 24. Positive slew rate vs. temperature

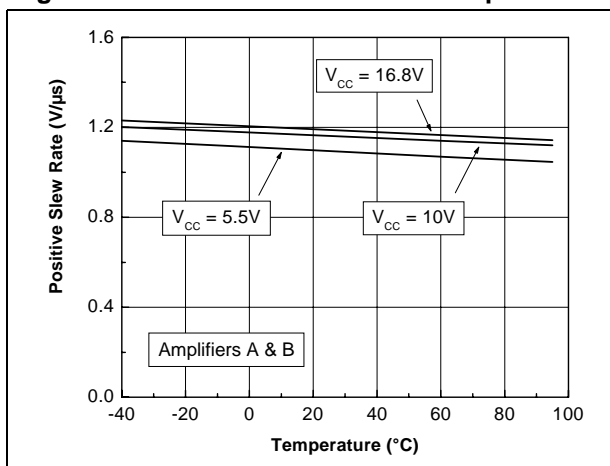

Figure 25. Positive slew rate vs. temperature

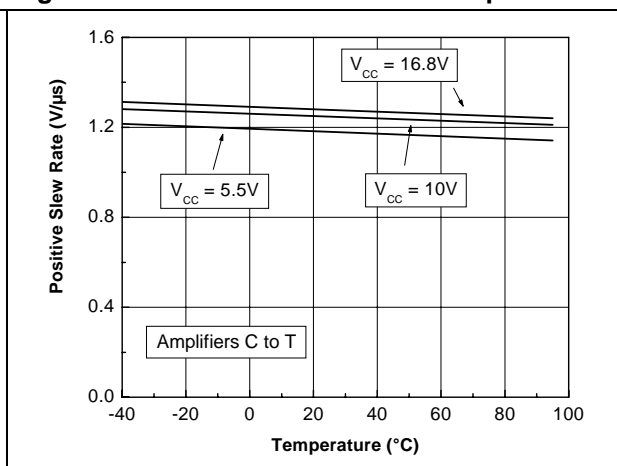

Figure 26. Positive slew rate vs. temperature

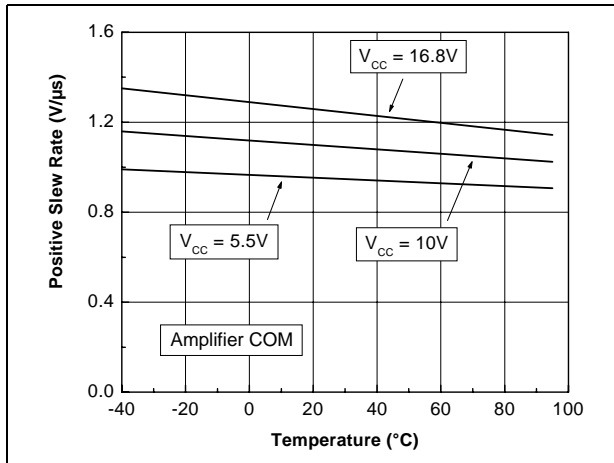

Figure 27. Negative slew rate vs. temperature

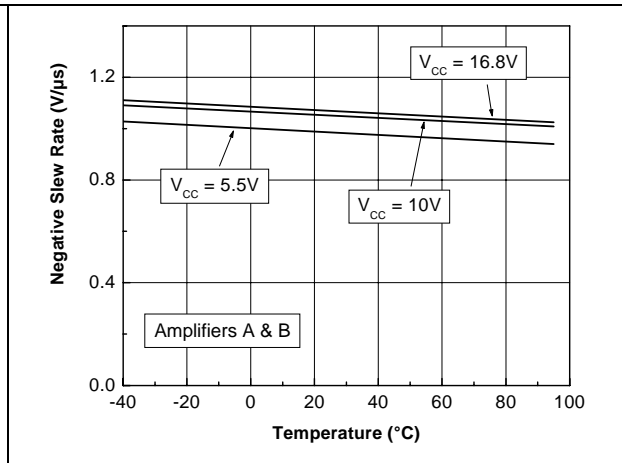

Figure 28. Negative slew rate vs. temperature

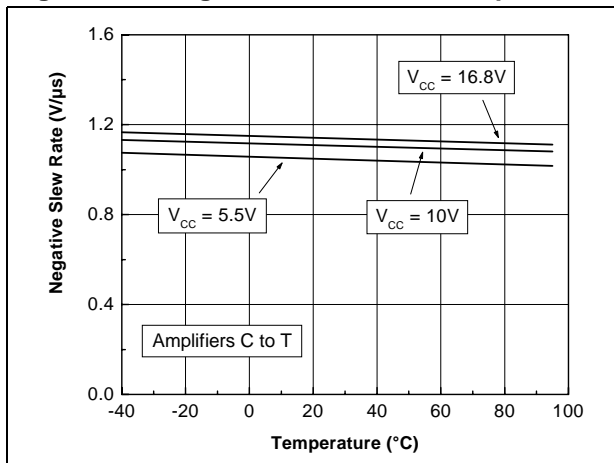

Figure 29. Negative slew rate vs. temperature

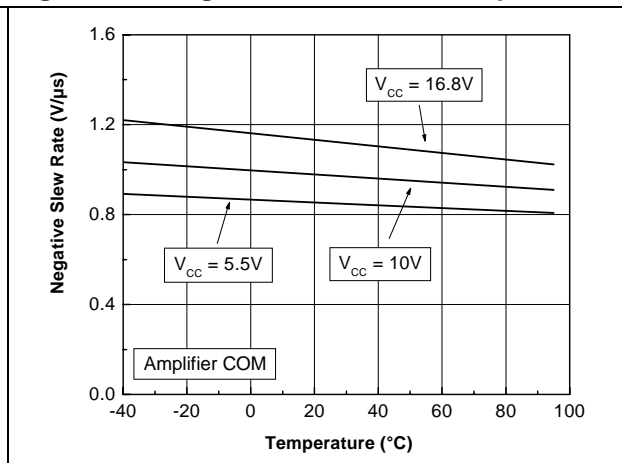

Figure 30. Large signal response - Amplifiers A & B

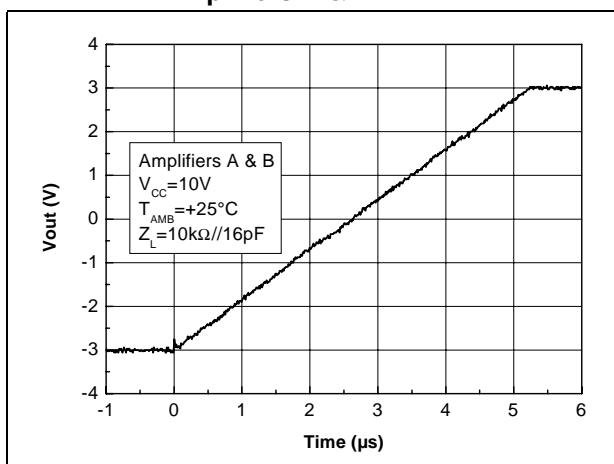

Figure 31. Large signal response - Amplifiers A & B

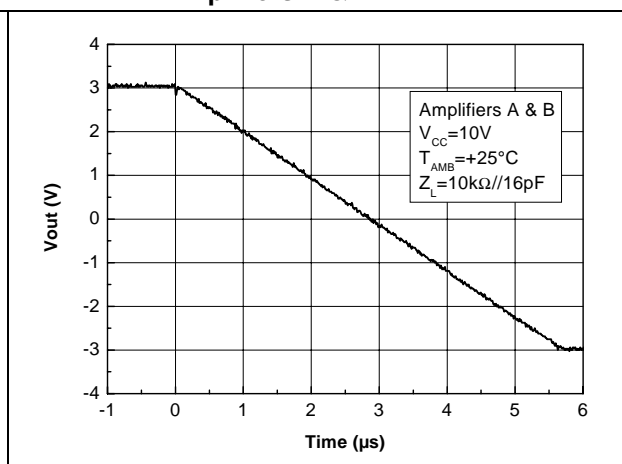

Figure 32. Large signal response - Amplifiers C to T

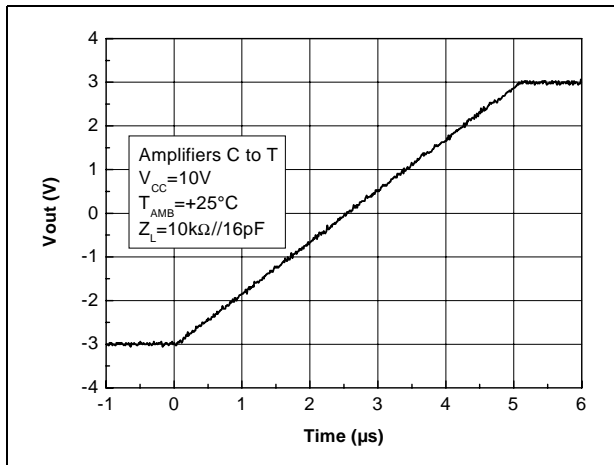

Figure 33. Large signal response - Amplifiers C to T

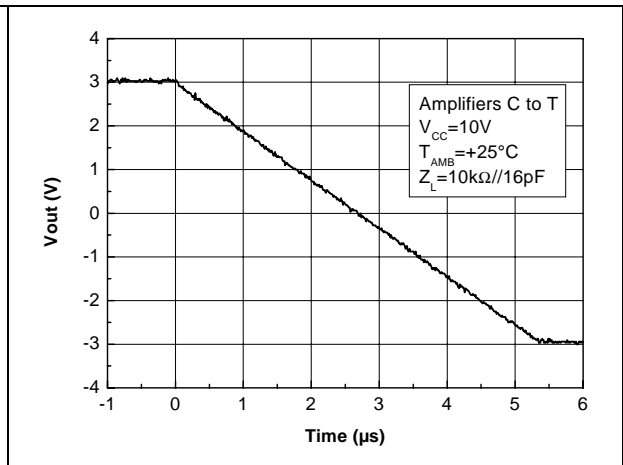

Figure 34. Large signal response - Amplifier COM

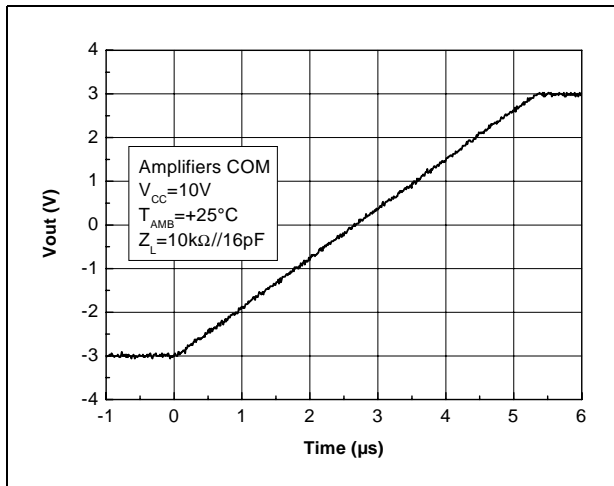

Figure 35. Large signal response - Amplifier COM

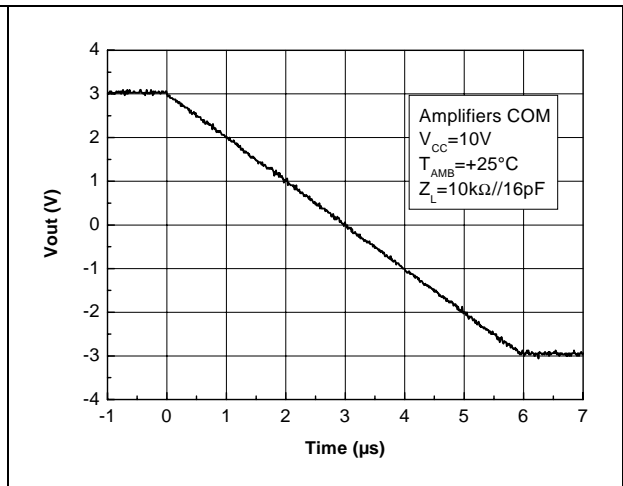

Figure 36. Small signal response - Amplifiers A & B

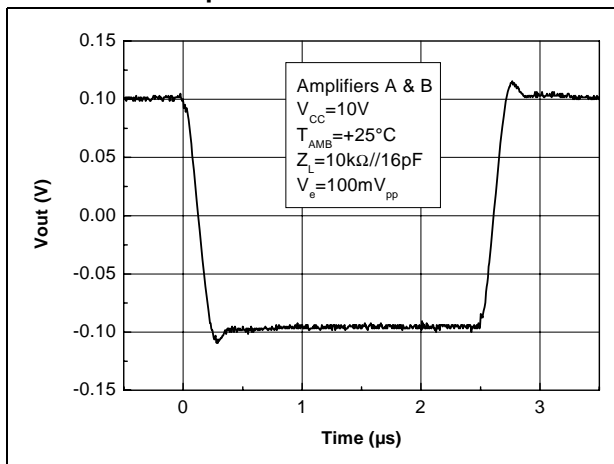

Figure 37. Small signal response - Amplifiers C to T

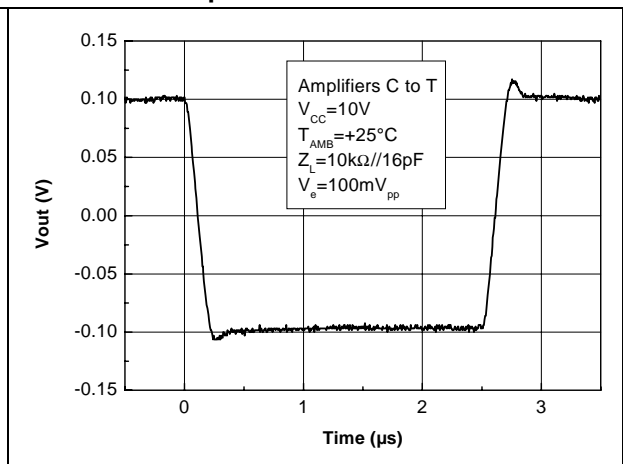

Figure 38. Small signal response - Amplifier COM

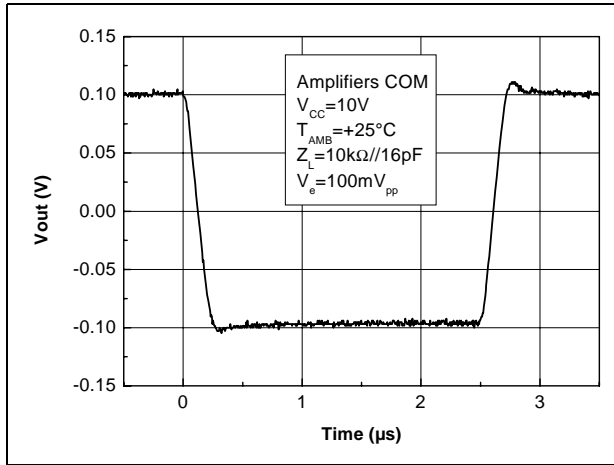

Figure 39. Output voltage response to current transient - Amplifiers A & B

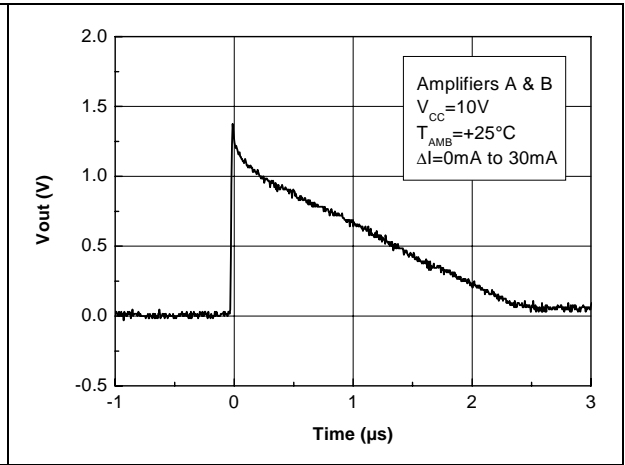

Figure 40. Output voltage response to current transient - Amplifiers A & B

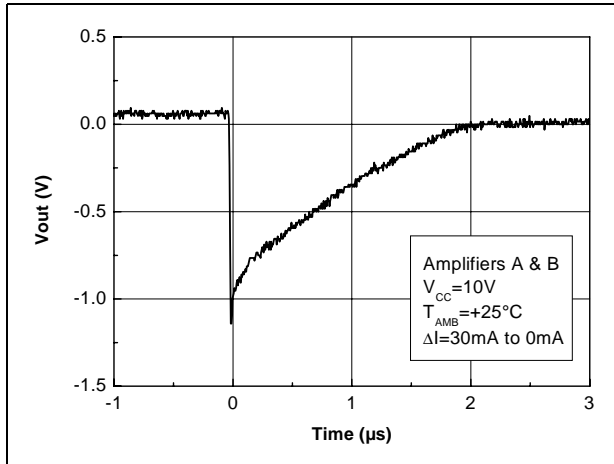

Figure 41. Output voltage response to current transient - Amplifiers C to T

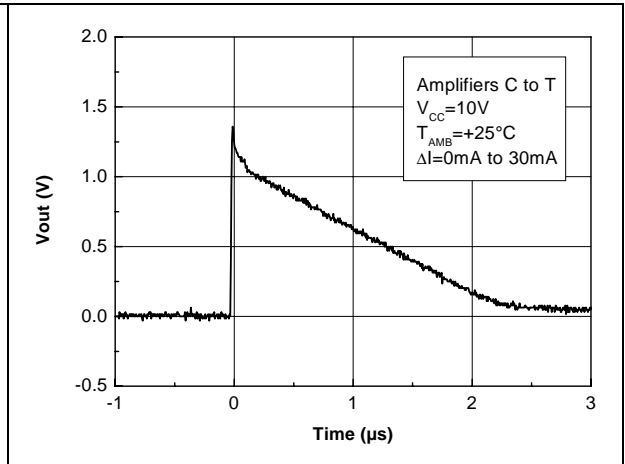

Figure 42. Output voltage response to current transient - Amplifiers C to T

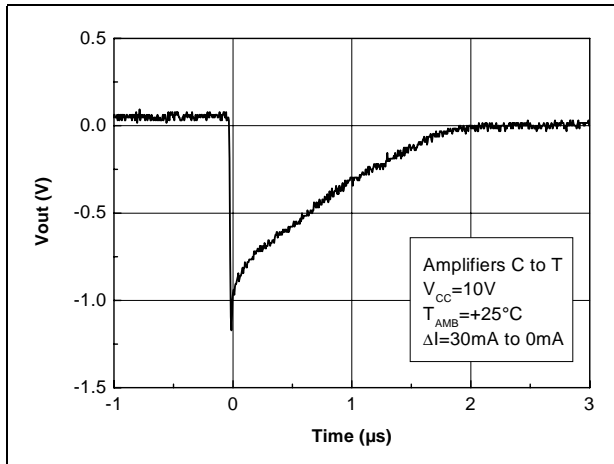

Figure 43. Output voltage response to current transient - Amplifier COM

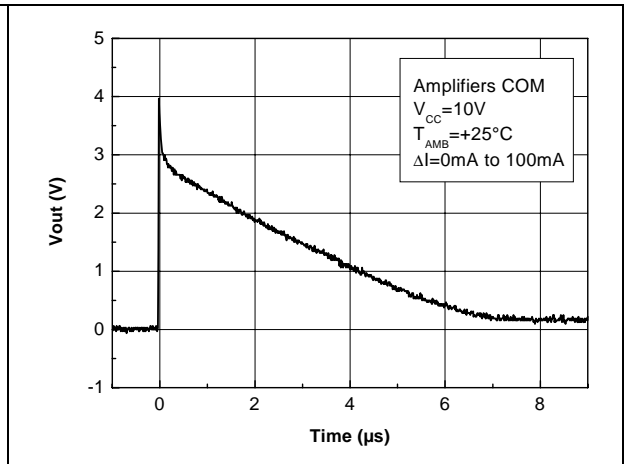

Figure 44. Output voltage response to current transient - Amplifier COM

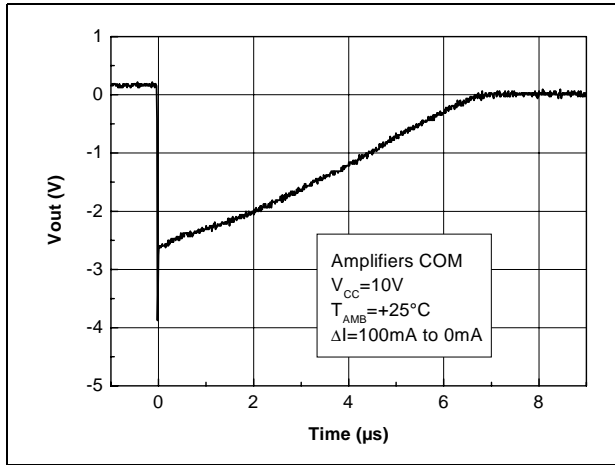

Figure 45. Output voltage response to current transient - Amplifier COM

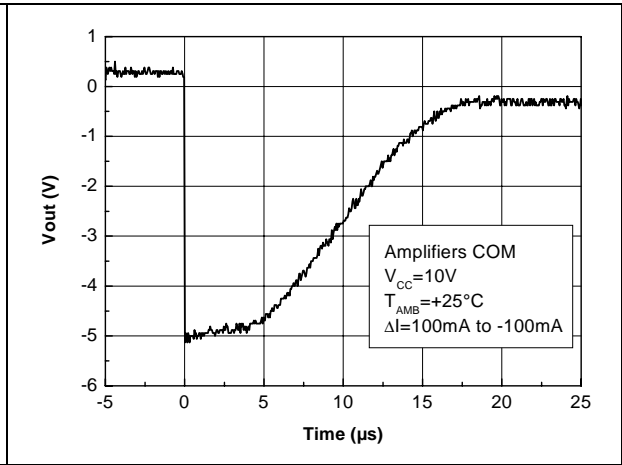
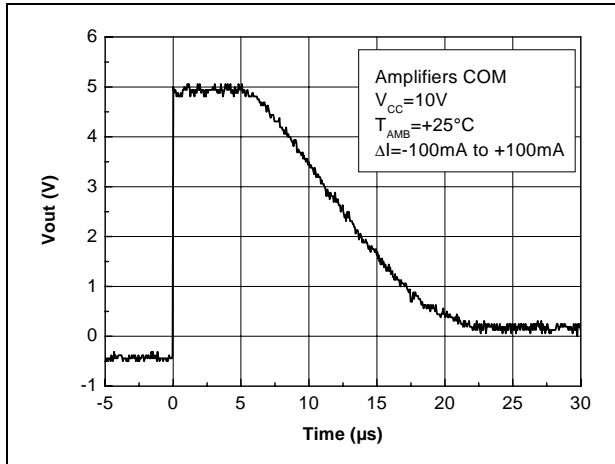

Figure 46. Output voltage response to current transient - Amplifier COM



4 Package information

In order to meet environmental requirements, STMicroelectronics offers these devices in ECOPACK[®] packages. These packages have a lead-free second level interconnect. The category of second level interconnect is marked on the package and on the inner box label, in compliance with JEDEC Standard JESD97. The maximum ratings related to soldering conditions are also marked on the inner box label. ECOPACK is an STMicroelectronics trademark. ECOPACK specifications are available at: www.st.com.

Table 4. TQFP48 ePad package mechanical data

| Ref. | Dimensions | | | | | |
|------|-------------|------|------|--------|-------|-------|
| | Millimeters | | | Inches | | |
| | Min. | Typ. | Max. | Min. | Typ. | Max. |
| A | | | 1.20 | | | 0.047 |
| A1 | 0.05 | | 0.15 | 0.002 | | 0.006 |
| A2 | 0.95 | 1.00 | 1.05 | 0.037 | 0.039 | 0.041 |
| b | 0.17 | 0.22 | 0.27 | 0.007 | 0.009 | 0.011 |
| c | 0.09 | | 0.20 | 0.004 | | 0.008 |
| D | 8.80 | 9.00 | 9.20 | 0.346 | 0.354 | 0.362 |
| D1 | 6.80 | 7.00 | 7.20 | 0.268 | 0.276 | 0.283 |
| D2 | 2.00 | | | 0.079 | | |
| D3 | | 5.50 | | | 0.217 | |
| E | 8.80 | 9.00 | 9.20 | 0.346 | 0.354 | 0.362 |
| E1 | 6.80 | 7.00 | 7.20 | 0.268 | 0.276 | 0.283 |
| E2 | 2.00 | | | 0.079 | | |
| E3 | | 5.50 | | | 0.217 | |
| e | | 0.50 | | | 0.020 | |
| L | 0.45 | 0.60 | 0.75 | 0.018 | 0.024 | 0.030 |
| L1 | | 1.00 | | | 0.039 | |
| k | 0° | 3.5° | 7° | 0° | 3.5° | 7° |
| ccc | | | 0.08 | | | 0.003 |

Figure 47. TQFP48 ePad package drawing

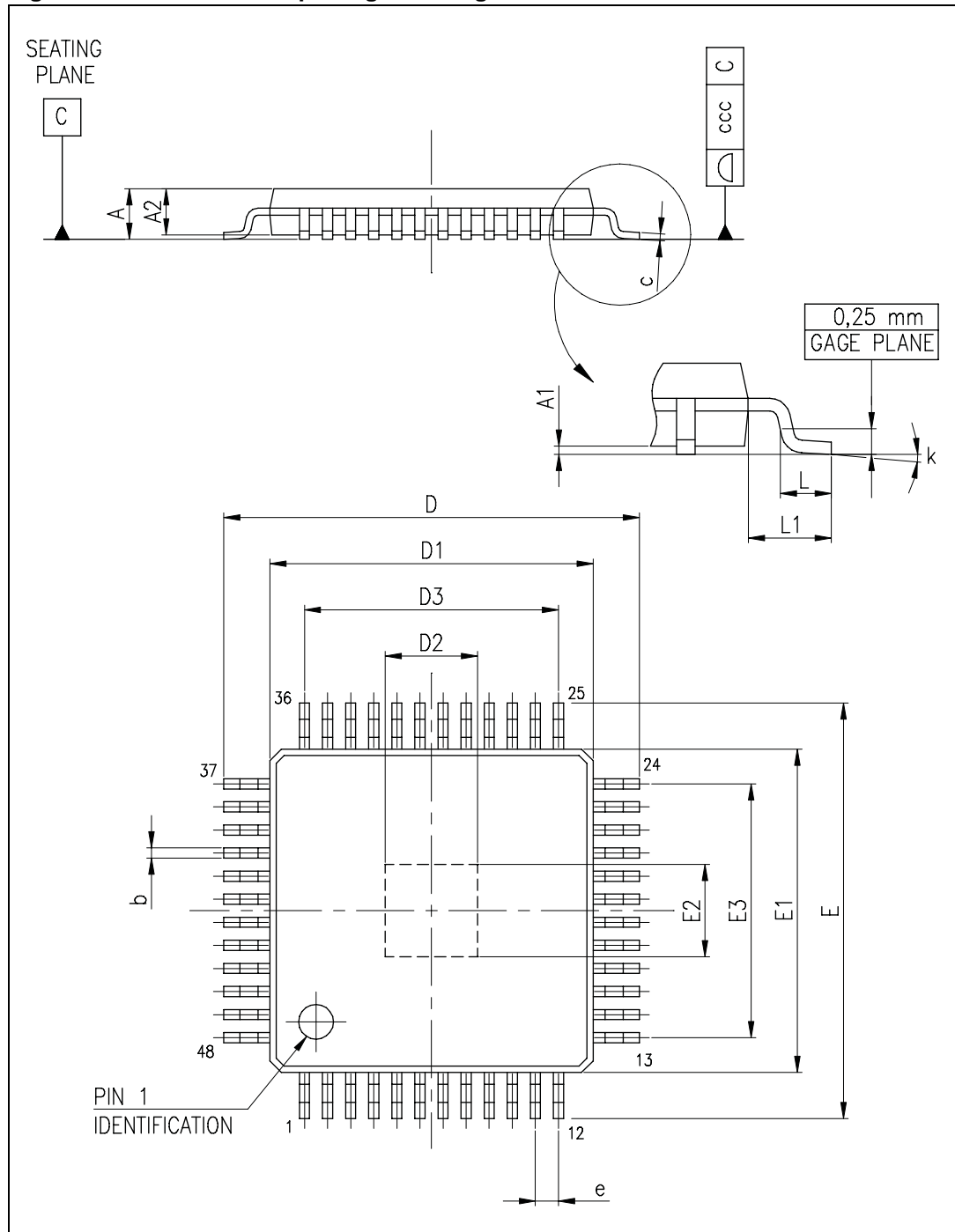

5 Ordering information

Table 5. Order codes

| Order code | Temperature range | Package | Packing | Marking |
|------------|-------------------|-------------|-------------|---------|
| TSL1020IF | -40°C to +95°C | TQFP48 ePad | Tray | SL1020I |
| TSL1020IFT | | | Tape & reel | |

6 Revision history

Table 6. Document revision history

| Date | Revision | Changes |
|-------------|----------|------------------|
| 28-Jan-2008 | 1 | Initial release. |

Please Read Carefully:

Information in this document is provided solely in connection with ST products. STMicroelectronics NV and its subsidiaries ("ST") reserve the right to make changes, corrections, modifications or improvements, to this document, and the products and services described herein at any time, without notice.

All ST products are sold pursuant to ST's terms and conditions of sale.

Purchasers are solely responsible for the choice, selection and use of the ST products and services described herein, and ST assumes no liability whatsoever relating to the choice, selection or use of the ST products and services described herein.

No license, express or implied, by estoppel or otherwise, to any intellectual property rights is granted under this document. If any part of this document refers to any third party products or services it shall not be deemed a license grant by ST for the use of such third party products or services, or any intellectual property contained therein or considered as a warranty covering the use in any manner whatsoever of such third party products or services or any intellectual property contained therein.

UNLESS OTHERWISE SET FORTH IN ST'S TERMS AND CONDITIONS OF SALE ST DISCLAIMS ANY EXPRESS OR IMPLIED WARRANTY WITH RESPECT TO THE USE AND/OR SALE OF ST PRODUCTS INCLUDING WITHOUT LIMITATION IMPLIED WARRANTIES OF MERCHANTABILITY, FITNESS FOR A PARTICULAR PURPOSE (AND THEIR EQUIVALENTS UNDER THE LAWS OF ANY JURISDICTION), OR INFRINGEMENT OF ANY PATENT, COPYRIGHT OR OTHER INTELLECTUAL PROPERTY RIGHT.

UNLESS EXPRESSLY APPROVED IN WRITING BY AN AUTHORIZED ST REPRESENTATIVE, ST PRODUCTS ARE NOT RECOMMENDED, AUTHORIZED OR WARRANTED FOR USE IN MILITARY, AIR CRAFT, SPACE, LIFE SAVING, OR LIFE SUSTAINING APPLICATIONS, NOR IN PRODUCTS OR SYSTEMS WHERE FAILURE OR MALFUNCTION MAY RESULT IN PERSONAL INJURY, DEATH, OR SEVERE PROPERTY OR ENVIRONMENTAL DAMAGE. ST PRODUCTS WHICH ARE NOT SPECIFIED AS "AUTOMOTIVE GRADE" MAY ONLY BE USED IN AUTOMOTIVE APPLICATIONS AT USER'S OWN RISK.

Resale of ST products with provisions different from the statements and/or technical features set forth in this document shall immediately void any warranty granted by ST for the ST product or service described herein and shall not create or extend in any manner whatsoever, any liability of ST.

ST and the ST logo are trademarks or registered trademarks of ST in various countries.

Information in this document supersedes and replaces all information previously supplied.

The ST logo is a registered trademark of STMicroelectronics. All other names are the property of their respective owners.

© 2008 STMicroelectronics - All rights reserved

STMicroelectronics group of companies

Australia - Belgium - Brazil - Canada - China - Czech Republic - Finland - France - Germany - Hong Kong - India - Israel - Italy - Japan - Malaysia - Malta - Morocco - Singapore - Spain - Sweden - Switzerland - United Kingdom - United States of America

www.st.com