



TAOS Inc.

is now

ams AG

The technical content of this TAOS datasheet is still valid.

Contact information:

Headquarters:

ams AG

Tobelbaderstrasse 30

8141 Unterpremstaetten, Austria

Tel: +43 (0) 3136 500 0

e-Mail: ams_sales@ams.com

Please visit our website at www.ams.com

Features

- **30× More Sensitive Than the TSL2560/61 Device**
- **Approximates Human Eye Response**
- **Programmable ALS Interrupt Function with User-Defined Upper and Lower Threshold Settings**
- **16-Bit Digital Output with I²C Fast-Mode at 400 kHz**
- **Programmable Analog Gain and Integration Time Supporting 1,000,000-to-1 Dynamic Range**
- **Available in Ultra-Small 1.25 mm × 1.75 mm ChipScale Package and Small 2 mm × 2 mm Flat No-Lead Package**
- **Automatically Rejects 50/60-Hz Lighting Ripple**
- **Low Quiescent Current 3 μA in Power Down Mode**
- **RoHS Compliant**

Applications

- **Ambient Light Sensor (ALS) for Display Brightness Control**

End Products and Market Segments

- **HDTVs**
- **Laptops and Tablets**
- **Mobile Handsets**
- **Monitors**

Description

The TSL2581 and TSL2583 are very-high sensitivity light-to-digital converters that transform light intensity to a digital signal output capable of direct I²C interface. Each device combines one broadband photodiode (visible plus infrared) and one infrared-responding photodiode on a single CMOS integrated circuit capable of providing a near-photopic response over an effective 16-bit dynamic range (16-bit resolution). Two integrating ADCs convert the photodiode currents to a digital output that represents the irradiance measured on each channel. This digital output can be input to a microprocessor where illuminance (ambient light level) in lux is derived using an empirical formula to approximate the human eye response. The TSL2581 device supports a traditional level style interrupt that remains asserted until the firmware clears it.

While useful for general purpose light sensing applications, the TSL2581/83 devices are designed particularly for displays (LCD, OLED, etc.) with the purpose of extending battery life and providing optimum viewing in diverse lighting conditions. Display panel backlighting, which can account for up to 50 to 60 percent of total platform power, can be automatically managed. Both devices are also ideal for controlling keyboard illumination based upon ambient lighting conditions. Illuminance information can further be used to manage exposure control in digital cameras. The TSL2581/83 devices are ideal in notebook/tablet PCs, LCD monitors, flat-panel televisions, cell phones, and digital cameras. In addition, other applications include street light control, security lighting, sunlight harvesting, machine vision, and automotive instrumentation clusters.

PACKAGE CS
6-LEAD CHIPSCALE
(TOP VIEW)

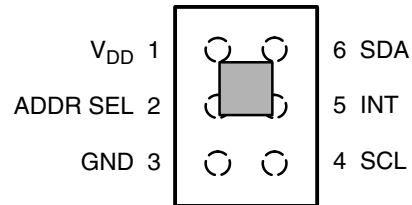

PACKAGE FN
DUAL FLAT NO-LEAD
(TOP VIEW)

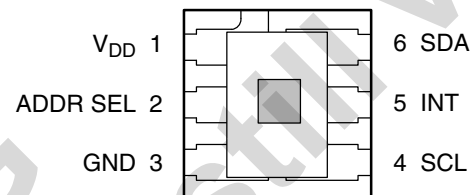

Package Drawings are Not to Scale

TSL2581, TSL2583 LIGHT-TO-DIGITAL CONVERTER

TAOS134A – JULY 2012

Functional Block Diagram

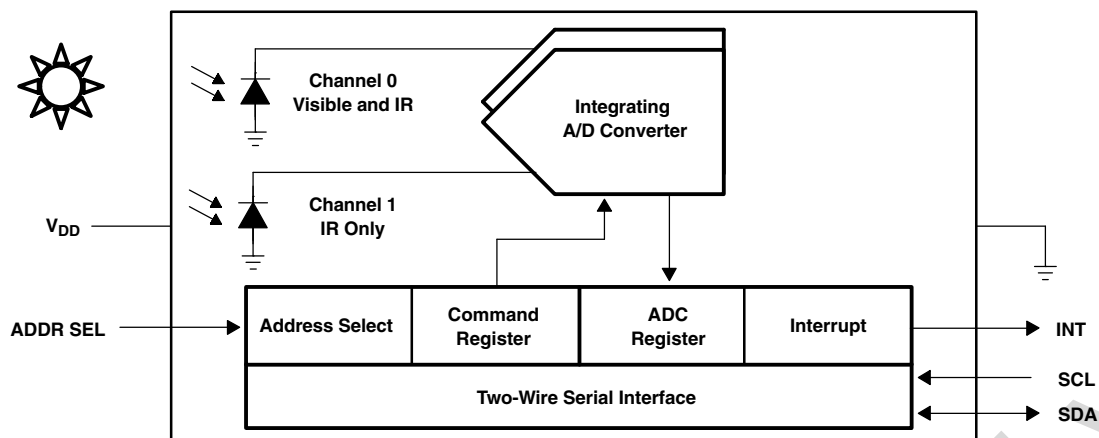

Detailed Description

The TSL2581 and TSL2583 are second-generation ambient light sensor devices. Each contains two integrating analog-to-digital converters (ADC) that integrate currents from two photodiodes. Integration of both channels occurs simultaneously. Upon completion of the conversion cycle, the conversion result is transferred to the Channel 0 and Channel 1 data registers, respectively. The transfers are double-buffered to ensure that the integrity of the data is maintained. After the transfer, the device automatically begins the next integration cycle.

Communication to the device is accomplished through a standard, two-wire I²C serial bus. Consequently, the TSL258x device can be easily connected to a microcontroller or embedded controller. No external circuitry is required for signal conditioning, thereby saving PCB real estate as well. Because the output of the TSL258x device is digital, the output is effectively immune to noise when compared to an analog signal.

The TSL258x devices also support an interrupt feature that simplifies and improves system efficiency by eliminating the need to poll a sensor for a light intensity value. The primary purpose of the interrupt function is to detect a meaningful change in light intensity. The concept of a *meaningful change* can be defined by the user both in terms of light intensity and time, or persistence, of that change in intensity. The TSL258x devices have the ability to define a threshold above and below the current light level. An interrupt is generated when the value of a conversion exceeds either of these limits.

Terminal Functions

TERMINAL NAME	NO.	TYPE	DESCRIPTION
ADDR SEL	2	I	Address select — three-state.
GND	3		Power supply ground. All voltages are referenced to GND.
INT	5	O	Interrupt — open drain.
SCL	4	I	Serial clock input terminal — clock signal.
SDA	6	I/O	Serial data I/O terminal — serial data I/O.
V _{DD}	1		Supply voltage.

Available Options

DEVICE	PACKAGE – LEADS	INTERFACE TYPE	ORDERING NUMBER
TSL2581	CS-6	I ² C Bus = V _{DD}	TSL2581CS
TSL2581	FN-6	I ² C Bus = V _{DD}	TSL2581FN
TSL2583†	CS-6	I ² C Bus = 1.8 V	TSL2583CS
TSL2583	FN-6	I ² C Bus = 1.8 V	TSL2583FN

† Contact TAOS for availability.

Absolute Maximum Ratings over operating free-air temperature range (unless otherwise noted)†

Supply voltage, V _{DD} (see Note 1)	3.8 V
Digital output voltage range, V _O	–0.5 V to 3.8 V
Digital output current, I _O	–1 mA to 20 mA
Storage temperature range, T _{stg}	–40°C to 85°C
ESD tolerance, human body model	2000 V

† Stresses beyond those listed under “absolute maximum ratings” may cause permanent damage to the device. These are stress ratings only, and functional operation of the device at these or any other conditions beyond those indicated under “recommended operating conditions” is not implied. Exposure to absolute-maximum-rated conditions for extended periods may affect device reliability.

NOTE 1: All voltages are with respect to GND.

Recommended Operating Conditions

	MIN	NOM	MAX	UNIT
Supply voltage, V _{DD}	2.7	3	3.6	V
Operating free-air temperature, T _A	–30		70	°C
SCL, SDA input low voltage, V _{IL}	TSL2581 (Note 2)		0.3 V _{DD}	V
	TSL2583 (Note 3)		0.54	
SCL, SDA input high voltage, V _{IH}	TSL2581 (Note 2)	0.7 V _{DD}		V
	TSL2583 (Note 3)	1.25		

NOTES: 2. Meets I²C specifications where V_{BUS} = V_{DD}.
3. Meets I²C specifications where V_{BUS} = 1.8 V.



TSL2581, TSL2583 LIGHT-TO-DIGITAL CONVERTER

TAOS134A – JULY 2012

Electrical Characteristics over recommended operating free-air temperature range (unless otherwise noted)

PARAMETER		TEST CONDITIONS	MIN	TYP	MAX	UNIT
I _{DD}	Supply current	Active		175	250	μA
		Power down — I ² C activity		3	10	μA
V _{OL}	INT, SDA output low voltage	3 mA sink current	0		0.4	V
		6 mA sink current	0		0.6	V
I _{LEAK}	Leakage current		-5		5	μA

Operating Characteristics, V_{DD} = 3 V, T_A = 25°C, (unless otherwise noted) (Notes 1, 2, 3, and 4)

PARAMETER		TEST CONDITIONS	CHANNEL	MIN	TYP	MAX	UNIT
f _{osc}	Oscillator frequency			705	750	795	kHz
Dark ADC count value	E _e = 0, ATIME = 0xB6 (200 ms), gain = 16×	Ch0	0	1	5	counts	
		Ch1	0	1	5		
Full scale ADC count value	ATIME = 0xDB (100 ms)	Ch0			37887	counts	
		Ch1			37887		
	ATIME = 0x6C (400 ms)	Ch0			65535		
		Ch1			65535		
ADC count value	λ _p = 625 nm, ATIME = 0xF6 (27 ms) E _e = 171.6 μW/cm ² , gain = 16×	Ch0	4000	5000	6000	counts	
		Ch1		700			
	λ _p = 850 nm, ATIME = 0xF6 (27 ms) E _e = 220 μW/cm ² , gain = 16×	Ch0	4000	5000	6000		
		Ch1		2750			
ADC count value ratio: Ch1/Ch0	λ _p = 625 nm		10.8	15.8	20.8	%	
	λ _p = 850 nm		41	55	68		
R _e	λ _p = 625 nm, ATIME = 0xF6 (27 ms)	Ch0		29.1		counts/ (μW/cm ²)	
		Ch1		4			
	λ _p = 850 nm, ATIME = 0xF6 (27 ms)	Ch0		22.8			
		Ch1		12.5			
Gain scaling (relative to 1×)	8×	Ch0	7	8	9	×	
		Ch1	7	8	9		
	16×	Ch0	15	16	17		
		Ch1	15	16	17		
	111×, decoupling capacitor 25 mm from V _{DD} pin (Note 5)	Ch0	97	107	115		
		Ch1	100	115	125		

- NOTES: 1. Optical measurements are made using small-angle incident radiation from light-emitting diode optical sources. Visible 640 nm LEDs and infrared 850 nm LEDs are used for final product testing for compatibility with high-volume production.
2. The 625 nm irradiance E_e is supplied by an AlInGaP light-emitting diode with the following characteristics: peak wavelength λ_p = 625 nm and spectral halfwidth Δλ_{1/2} = 20 nm.
3. The 850 nm irradiance E_e is supplied by a light-emitting diode with the following characteristics: peak wavelength λ_p = 850 nm and spectral halfwidth Δλ_{1/2} = 42 nm.
4. The integration time T_{int} is dependent on internal oscillator frequency (f_{osc}) and on the number of integration cycles (ATIME) in the Timing Register (0xFF) as described in the Register section. For nominal f_{osc} = 750 kHz, nominal T_{int} = 2.7 ms × ATIME.
5. 111× gain is affected by the line inductance between the V_{DD} pin and the decoupling capacitor. See Figure 3 for 111× gain scale versus line inductance characteristic.

AC Electrical Characteristics, $V_{DD} = 3\text{ V}$, $T_A = 25^\circ\text{C}$ (unless otherwise noted)

PARAMETER†		TEST CONDITIONS	MIN	TYP	MAX	UNIT
$t_{(CONV)}$	Conversion time		2.7		688	ms
$f_{(SCL)}$	Clock frequency		0		400	kHz
$t_{(BUF)}$	Bus free time between start and stop condition		1.3			μs
$t_{(HDSTA)}$	Hold time after (repeated) start condition. After this period, the first clock is generated.		0.6			μs
$t_{(SUSTA)}$	Repeated start condition setup time		0.6			μs
$t_{(SUSTO)}$	Stop condition setup time		0.6			μs
$t_{(HDDAT)}$	Data hold time		0		0.9	μs
$t_{(SUDAT)}$	Data setup time		100			ns
$t_{(LOW)}$	SCL clock low period		1.3			μs
$t_{(HIGH)}$	SCL clock high period		0.6			μs
t_F	Clock/data fall time				300	ns
t_R	Clock/data rise time				300	ns
C_i	Input pin capacitance				10	pF

† Specified by design and characterization; not production tested.

PARAMETER MEASUREMENT INFORMATION

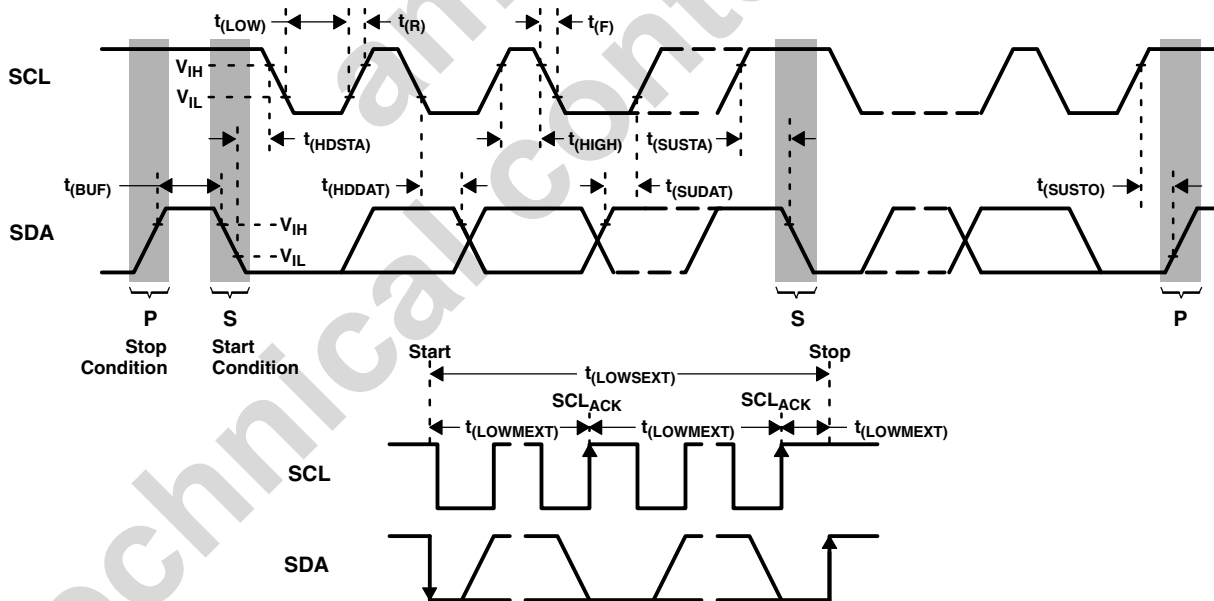

Figure 1. Timing Diagrams

TYPICAL CHARACTERISTICS

SPECTRAL RESPONSIVITY

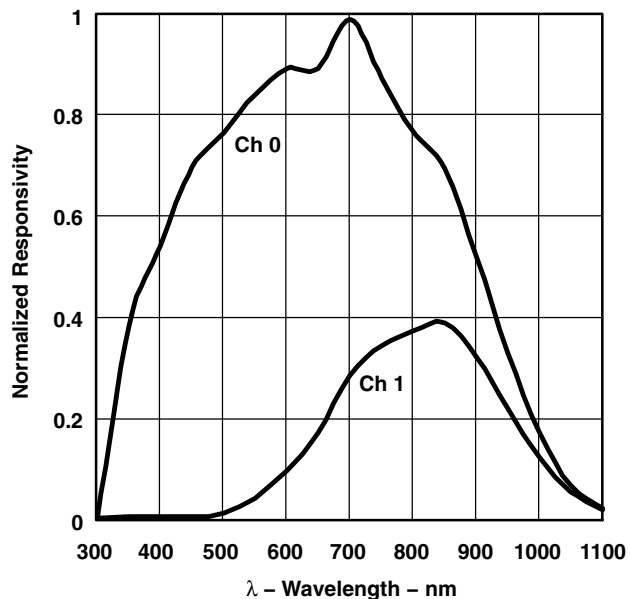

Figure 2

111× GAIN SCALE
 vs.
 LINE INDUCTANCE

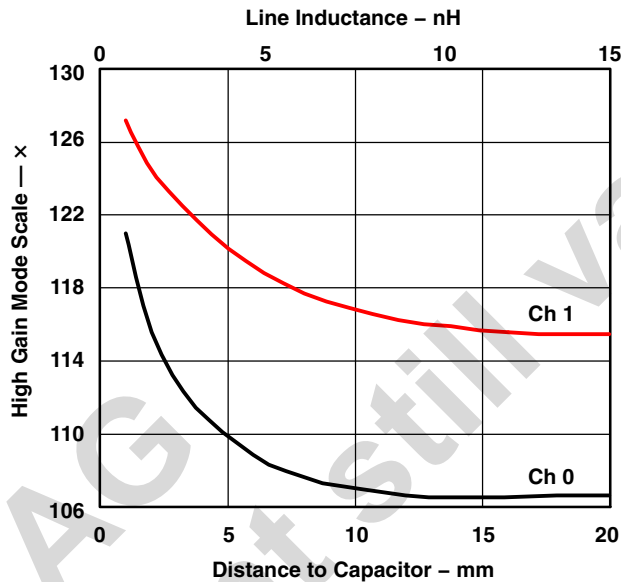

Figure 3

NORMALIZED RESPONSIVITY
 vs.
 ANGULAR DISPLACEMENT

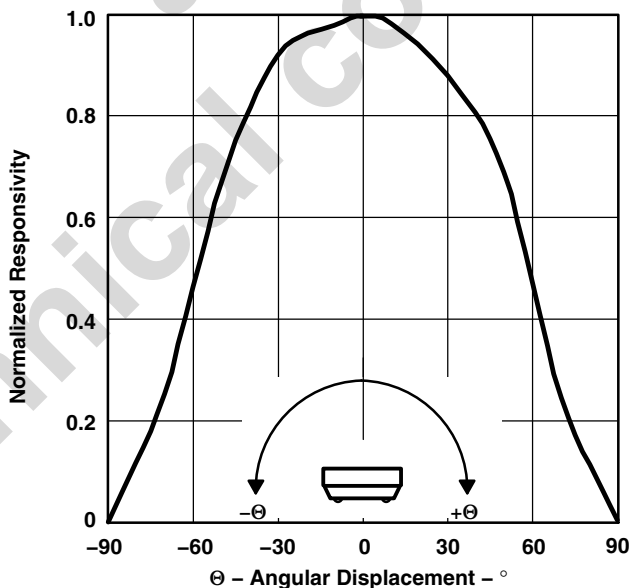

Figure 4

PRINCIPLES OF OPERATION

Analog-to-Digital Converter

The TSL258x contains two integrating analog-to-digital converters (ADC) that integrate the currents from the channel 0 and channel 1 photodiodes. Integration of both channels occurs simultaneously, and upon completion of the conversion cycle the conversion result is transferred to the channel 0 and channel 1 data registers, respectively. The transfers are double buffered to ensure that invalid data is not read during the transfer. After the transfer, the device automatically begins the next integration cycle.

Digital Interface

Interface and control of the TSL258x is accomplished through a two-wire serial interface to a set of registers that provide access to device control functions and output data. The serial interface is compatible with I²C bus Fast-Mode. The TSL258x offers three slave addresses that are selectable via an external pin (ADDR SEL). The slave address options are shown in Table 1.

Table 1. Slave Address Selection

ADDR SEL TERMINAL LEVEL	SLAVE ADDRESS
GND	0101001
Float	0111001
V _{DD}	1001001

NOTE: A read/write bit should be appended to the slave address by the master device to properly communicate with the TSL258x device.

TSL2581, TSL2583 LIGHT-TO-DIGITAL CONVERTER

TAOS134A – JULY 2012

I²C Protocol

Interface and control are accomplished through an I²C serial compatible interface (standard or fast mode) to a set of registers that provide access to device control functions and output data. The devices support the 7-bit I²C addressing protocol.

The I²C standard provides for three types of bus transaction: read, write, and a combined protocol (Figure 5). During a write operation, the first byte written is a command byte followed by data. In a combined protocol, the first byte written is the command byte followed by reading a series of bytes. If a read command is issued, the register address from the previous command will be used for data access. Likewise, if the MSB of the command is not set, the device will write a series of bytes at the address stored in the last valid command with a register address. The command byte contains either control information or a 5-bit register address. The control commands can also be used to clear interrupts.

The I²C bus protocol was developed by Philips (now NXP). For a complete description of the I²C protocol, please review the NXP I²C design specification at <http://www.i2c-bus.org/references/>.

- A** Acknowledge (0)
- N** Not Acknowledged (1)
- P** Stop Condition
- R** Read (1)
- S** Start Condition
- Sr** Repeated Start Condition
- W** Write (0)
- ...** Continuation of protocol
- Master-to-Slave
- Slave-to-Master

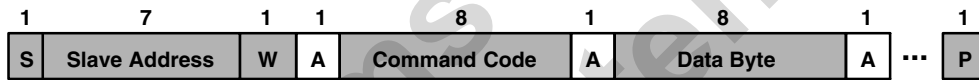

I²C Write Protocol



I²C Read Protocol

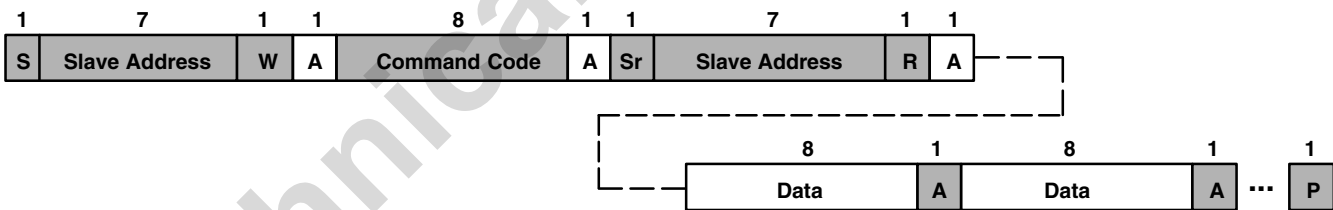

I²C Read Protocol — Combined Format

Figure 5. I²C Protocols

Register Set

The TSL258x is controlled and monitored by sixteen registers and a command register accessed through the serial interface. These registers provide for a variety of control functions and can be read to determine results of the ADC conversions. The register set is summarized in Table 2.

Table 2. Register Address

ADDRESS	REGISTER NAME	REGISTER FUNCTION	R/W
--	COMMAND	Specifies register address	W
00h	CONTROL	Control of basic functions	R/W
01h	TIMING	Integration time/gain control	
02h	INTERRUPT	Interrupt control	
03h	TLLOW	Low byte of low interrupt threshold	
04h	TLHIGH	High byte of low interrupt threshold	
05h	THLOW	Low byte of high interrupt threshold	
06h	THHIGH	High byte of high interrupt threshold	
07h	ANALOG	Analog control register	
12h	ID	Part number / Rev ID	R
14h	DATA0LOW	ADC channel 0 LOW data register	
15h	DATA0HIGH	ADC channel 0 HIGH data register	
16h	DATA1LOW	ADC channel 1 LOW data register	
17h	DATA1HIGH	ADC channel 1 HIGH data register	
18h	TIMERLOW	Manual integration timer LOW register	
19h	TIMERHIGH	Manual integration timer HIGH register	
1Eh	ID2	TSL2581 / TSL2583 ID	R/W

The mechanics of accessing a specific register is given in the I²C Protocol section. In general, the COMMAND register is written first to specify the specific control/status register for following read/write operations.



TSL2581, TSL2583 LIGHT-TO-DIGITAL CONVERTER

TAOS134A – JULY 2012

Command Register

The command register specifies the address of the target register for subsequent read and write operations and contains eight bits as described in Table 3. The command register defaults to 00h at power on.

Table 3. Command Register

Bit:	7	6	5	4	3	2	1	0	
	CMD		TRANSACTION		ADDRESS				Reset 00h
FIELD	BIT	DESCRIPTION							
CMD	7	Select command register. Must write as 1 when addressing COMMAND register.							
TRANSACTION	6:5	Select type of transaction to follow in subsequent data transfers:							
		FIELD VALUE	DESCRIPTION						
		00	Repeated byte protocol transaction						
		01	Auto-increment protocol transaction						
		10	Reserved — Do not use						
		11	Special function — See description below						
		Transaction type 00 will repeatedly read the same register with each data access. Transaction type 01 will provide an auto-increment function to read successive register bytes.							
ADDRESS	4:0	Address field/special function field. Depending on the transaction type, see above, this field either specifies a special function command or selects the specific control-status-register for following write and read transactions. The field values listed below apply only to special function commands:							
		FIELD VALUE	DESCRIPTION						
		00000	Reserved. Write as 0000b.						
		00001	Clear any pending interrupt and is a write-once-to-clear bit						
		00010	When the Timing Register is set to 00h, a SendByte command with the ADDRESS field set to 0010b will stop a manual integration. The actual length of the integration cycle may be read in the MANUAL INTEGRATION TIMER Register.						
		00011	When the Timing Register is set to 00h, a SendByte command with the ADDRESS field set to 0011b will start a manual integration. The actual length of the integration cycle may be read in the MANUAL INTEGRATION TIMER Register.						
		x11xx	Reserved. Write as 11xxb.						

NOTE: An I²C block transaction will continue until the Master sends a stop condition. Only the Send Byte Protocol should be used when clearing interrupts.

Control Register (00h)

The CONTROL register primarily used to power the TSL258x device up and down as shown in Table 4.

Table 4. Control Register

Bit:	7	6	5	4	3	2	1	0	
Address 00h	Reserved		ADC_INTR	ADC_VALID	Reserved		ADC_EN	POWER	Reset 00h

FIELD	BIT	DESCRIPTION
Reserved	7:6	Reserved. Write as 0.
ADC_INTR	5	ADC Interrupt. Read only. Indicates that the device is asserting an interrupt.
ADC_VALID	4	ADC Valid. Read only. Indicates that the ADC channel has completed an integration cycle.
Reserved	3:2	Reserved. Write as 0.
ADC_EN	1	ADC Enable. This field enables the two ADC channels to begin integration. Writing a 1 activates the ADC channels, and writing a 0 disables the ADCs.
POWER	0	Power On. Writing a 1 powers on the device, and writing a 0 turns it off.

NOTE: ADC_EN and POWER must be asserted before the ADC changes will operate correctly. After POWER is asserted, a 2-ms delay is required before asserting ADC_EN.

NOTE: The TSL258x device registers should be configured before ADC_EN is asserted.

Timing Register (01h)

The TIMING register controls the internal integration time of the ADC channels in 2.7-ms increments. The TIMING register defaults to 00h at power on.

Table 5. Timing Register

Bit:	7	6	5	4	3	2	1	0	
Address 01h	ATIME								Reset 00h

FIELD	BIT	DESCRIPTION																											
ATIME	7:0	Integration Cycles. Specifies the integration time in 2.7-ms intervals. Time is expressed as a 2's complement number. So, to quickly work out the correct value to write: (1) determine the number of 2.7-ms intervals required, and (2) then take the 2's complement. For example, for a 1 × 2.7-ms interval, 0xFF should be written. For 2 × 2.7-ms intervals, 0xFE should be written. The maximum integration time is 688.5 ms (0000001b).																											
		Writing a 0x00 to this register is a special case and indicates manual timing mode. See CONTROL and MANUAL INTEGRATION TIMER Registers for other device options related to manual integration.																											
		<table border="1"> <thead> <tr> <th>INTEG_CYCLES</th> <th>TIME</th> <th>VALUE</th> </tr> </thead> <tbody> <tr> <td>–</td> <td>Manual integration</td> <td>00000000</td> </tr> <tr> <td>1</td> <td>2.7 ms</td> <td>11111111</td> </tr> <tr> <td>2</td> <td>5.4 ms</td> <td>11111110</td> </tr> <tr> <td>19</td> <td>51.3 ms</td> <td>11101101</td> </tr> <tr> <td>37</td> <td>99.9 ms</td> <td>11011011</td> </tr> <tr> <td>74</td> <td>199.8 ms</td> <td>10110110</td> </tr> <tr> <td>148</td> <td>399.6 ms</td> <td>01101100</td> </tr> <tr> <td>255</td> <td>688.5 ms</td> <td>00000001</td> </tr> </tbody> </table>	INTEG_CYCLES	TIME	VALUE	–	Manual integration	00000000	1	2.7 ms	11111111	2	5.4 ms	11111110	19	51.3 ms	11101101	37	99.9 ms	11011011	74	199.8 ms	10110110	148	399.6 ms	01101100	255	688.5 ms	00000001
		INTEG_CYCLES	TIME	VALUE																									
		–	Manual integration	00000000																									
		1	2.7 ms	11111111																									
		2	5.4 ms	11111110																									
		19	51.3 ms	11101101																									
		37	99.9 ms	11011011																									
74	199.8 ms	10110110																											
148	399.6 ms	01101100																											
255	688.5 ms	00000001																											

NOTE: The Send Byte protocol cannot be used when ATIME is greater than 127 (for example ATIME[7] = 1) since the upper bit is set aside for write transactions in the COMMAND register.



TSL2581, TSL2583 LIGHT-TO-DIGITAL CONVERTER

TAOS134A – JULY 2012

Interrupt Register (02h)

The INTERRUPT register controls the extensive interrupt capabilities of the device. The open-drain interrupt pin is active low and requires a pull-up resistor to V_{BUS} in order to pull high in the inactive state. The Interrupt Register provides control over when a meaningful interrupt will occur. The concept of meaningful change can be defined by the user both in terms of light intensity and time, or persistence of that change in intensity. The value must cross the threshold (as configured in the Threshold Registers 03h through 06h) and persist for some period of time, as outlined in Table 8.

When a level Interrupt is selected, an interrupt is generated whenever the last conversion results in a value outside of the programmed threshold window. The interrupt is active-low and remains asserted until cleared by writing an 11 in the TRANSACTION field in the COMMAND register.

Note: Interrupts are based on the value of Channel 0 only.

Table 6. Interrupt Control Register

Bit:	7	6	5	4	3	2	1	0	Reset
Address 02h	Resv	INTR_STOP	Resv	INTR	PERSIST				00h

FIELD	BITS	DESCRIPTION
Resv	7	Reserved. Write as 0.
INTR_STOP	6	Stop ADC integration on interrupt. When high, ADC integration will stop once an interrupt is asserted. To resume operation (1) de-assert ADC_EN using CONTROL register, (2) clear interrupt using COMMAND register, and (3) re-assert ADC_EN using CONTROL register. Note: Use this bit to isolate a particular condition when the sensor is continuously integrating.
Resv	5	Reserved. Write as 0.
INTR	4	INTR Control Select. This field determines mode of interrupt logic according to Table 7, below.
PERSIST	3:0	Interrupt persistence. Controls rate of interrupts to the host processor as shown in Table 8, below.

Table 7. Interrupt Control Select

INTR FIELD VALUE	READ VALUE
0	Interrupt output disabled
1	Level Interrupt

Table 8. Interrupt Persistence Select

PERSIST FIELD VALUE	INTERRUPT PERSIST FUNCTION
0000	Every ADC cycle generates interrupt
0001	Any value outside of threshold range
0010	2 integration time periods out of range
0011	3 integration time periods out of range
0100	4 integration time periods out of range
0101	5 integration time periods out of range
0110	6 integration time periods out of range
0111	7 integration time periods out of range
1000	8 integration time periods out of range
1001	9 integration time periods out of range
1010	10 integration time periods out of range
1011	11 integration time periods out of range
1100	12 integration time periods out of range
1101	13 integration time periods out of range
1110	14 integration time periods out of range
1111	15 integration time periods out of range

ams A... valid
 Technical content still valid

TSL2581, TSL2583 LIGHT-TO-DIGITAL CONVERTER

TAOS134A – JULY 2012

Interrupt Threshold Registers (03h – 06h)

The interrupt threshold registers store the values to be used as the high and low trigger points for the comparison function for interrupt generation. If the value generated by channel 0 crosses below or is equal to the low threshold specified, an interrupt is asserted on the interrupt pin. If the value generated by channel 0 crosses above the high threshold specified, an interrupt is asserted on the interrupt pin. Registers TLOW and TLHIGH provide the low byte and high byte, respectively, of the lower interrupt threshold. Registers THLOW and THHIGH provide the low and high bytes, respectively, of the upper interrupt threshold. The high and low bytes from each set of registers are combined to form a 16-bit threshold value. The interrupt threshold registers default to 00h on power up.

Table 9. Interrupt Threshold Registers

REGISTER	ADDRESS	BITS	DESCRIPTION
TLOW	3h	7:0	ADC channel 0 lower byte of the low threshold
TLHIGH	4h	7:0	ADC channel 0 upper byte of the low threshold
THLOW	5h	7:0	ADC channel 0 lower byte of the high threshold
THHIGH	6h	7:0	ADC channel 0 upper byte of the high threshold

NOTE: Since two 8-bit values are combined for a single 16-bit value for each of the high and low interrupt thresholds, the Send Byte protocol should not be used to write to these registers. Any values transferred by the Send Byte protocol with the MSB set would be interpreted as the COMMAND field and stored as an address for subsequent read/write operations and not as the interrupt threshold information as desired. The Write Word protocol should be used to write byte-paired registers. For example, the TLOW and TLHIGH registers (as well as the THLOW and THHIGH registers) can be written together to set the 16-bit ADC value in a single transaction.

Analog Register (07h)

The ANALOG register provides eight bits of control to the analog block. These bits control the analog gain settings of the device.

Table 10. Analog Register

Bit:	7	6	5	4	3	2	1	0	Reset
Address 07h	RESV						GAIN		00h
FIELD	BITS		DESCRIPTION						
Resv	7:3		Reserved. Write as 0.						
Gain	2:0	Gain Control. Sets the analog gain of the device according to the following table.							
		FIELD VALUE			GAIN VALUE				
		x00			1×				
		x01			8×				
		x10			16×				
x11			111×						

ID Register (12h)

The ID register provides the value for both the part number and silicon revision number for that part number. It is a read-only register whose value never changes.

Table 11. ID Register

Bit:	7	6	5	4	3	2	1	0		
Address 12h	PARTNO						REVNO			Reset --
FIELD	BITS	DESCRIPTION								
PARTNO	7:4	Part Number Identification: field value 1001b								
REVNO	3:0	Revision number identification								

ADC Channel Data Registers (14h – 17h)

The ADC channel data are expressed as 16-bit values spread across two registers. The ADC channel 0 data registers, DATA0LOW and DATA0HIGH provide the lower and upper bytes, respectively, of the ADC value of channel 0. Registers DATA1LOW and DATA1HIGH provide the lower and upper bytes, respectively, of the ADC value of channel 1. All channel data registers are read-only and default to 00h on power up.

Table 12. ADC Channel Data Registers

REGISTER	ADDRESS	BITS	DESCRIPTION
DATA0LOW	14h	7:0	ADC channel 0 lower byte
DATA0HIGH	15h	7:0	ADC channel 0 upper byte
DATA1LOW	16h	7:0	ADC channel 1 lower byte
DATA1HIGH	17h	7:0	ADC channel 1 upper byte

The upper byte data registers can only be read following a read to the corresponding lower byte register. When the lower byte register is read, the upper eight bits are strobed into a shadow register, which is read by a subsequent read to the upper byte. The upper register will read the correct value even if additional ADC integration cycles end between the reading of the lower and upper registers.

NOTE: The Read Word protocol can be used to read byte-paired registers. For example, the DATA0LOW and DATA0HIGH registers (as well as the DATA1LOW and DATA1HIGH registers) may be read together to obtain the 16-bit ADC value in a single transaction

Manual Integration Timer Registers (18h – 19h)

The MANUAL INTEGRATION TIMER registers provide the number of cycles in 10.9 μ s increments that occurred during a manual start/stop integration period. The timer is expressed as a 16-bit value across two registers. See CONTROL and TIMING Registers for further instructions in configuring a manual integration. The maximum time that can be derived without an overflow is 714.3 ms.

Table 13. Manual Integration Timer Registers

Bit:	7	6	5	4	3	2	1	0	
Address 18h 19h	TIMER								Reset 00h
REGISTER	ADDRESS	BITS	DESCRIPTION						
TIMERLOW	18h	7:0	Manual Integration Timer lower byte						
TIMERHIGH	19h	7:0	Manual Integration Timer upper byte						



TSL2581, TSL2583 LIGHT-TO-DIGITAL CONVERTER

TAOS134A – JULY 2012

ID2 Register (1Eh)

In combination with the ID register, the ID2 register provides a means to identify the device as a TSL2581 or a TSL2583. Although this is a W/R register, it is strongly advised that this register not be written to. Any value written to this register could adversely affect the performance of the device.

Table 14. ID2 Register

Bit:	7	6	5	4	3	2	1	0	
Address 00h	Reserved		ID			Reserved			Reset 00h

FIELD	BIT	DESCRIPTION
Reserved	7:6	Reserved.
ID	5:4	ID. 00b = TSL2581, 11b = TSL2583
Reserved	3:0	Reserved.

APPLICATION INFORMATION: SOFTWARE

Basic Operation

After applying V_{DD} , the device will initially be in the power-down state. To operate the device, issue a command to access the CONTROL register followed by the data value 01h to the CONTROL register to power up the device. The TIMING register should be configured for the preferred integration period, and then the ADC_EN should be set to 1 to enable both ADC channels.

For example code that illustrates initializing and reading the device, see TAOS Designer’s Notebook Number 42: *TSL258x: Accurate ADC Readings after Enable*.

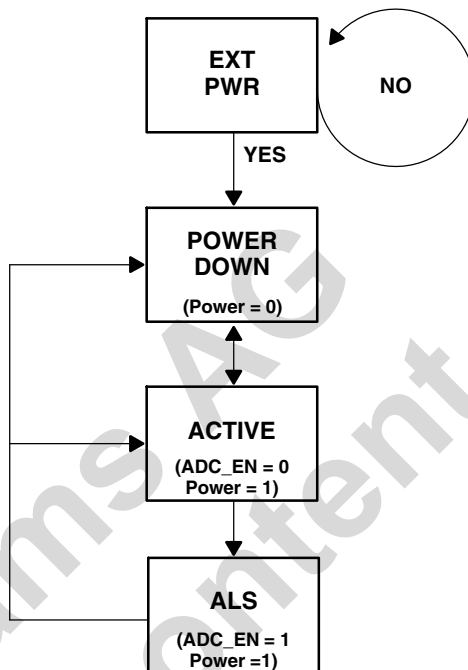

Figure 6. State Diagram

APPLICATION INFORMATION: SOFTWARE

Interrupts

The interrupt feature of the TSL258x device simplifies and improves system efficiency by eliminating the need to poll the sensor for a light intensity value. Interrupt mode is determined by the INTR field in the INTERRUPT CONTROL Register. The interrupt feature may be disabled by writing a field value of 00h to the Interrupt Control Register (02h) so that polling can be performed.

The versatility of the interrupt feature provides many options for interrupt configuration and usage. The primary purpose of the interrupt function is to signal a meaningful change in light intensity. However, it can also be used as an end-of-conversion signal. The concept of a meaningful change can be defined by the user both in terms of light intensity and time, or persistence, of that change in intensity. The TSL258x device implements two 16-bit-wide interrupt threshold registers that allow the user to define thresholds above and below a desired light level. An interrupt will then be generated when the value of a conversion exceeds either of these limits. For simplicity of programming, the threshold comparison is accomplished only with Channel 0. This simplifies calculation of thresholds that are based, for example, on a percent of the current light level. It is adequate to use only one channel when calculating light intensity differences because, for a given light source, the channel 0 and channel 1 values are linearly proportional to each other and thus both values scale linearly with light intensity.

To further control when an interrupt occurs, the TSL258x device provides an interrupt persistence feature. This feature allows the user to specify a number of conversion cycles for which a light intensity exceeding either interrupt threshold must persist before actually generating an interrupt. This can be used to prevent transient changes in light intensity from generating an unwanted interrupt. With a value of 1, an interrupt occurs immediately whenever either threshold is exceeded. With values of N , where N can range from 2 to 15, N consecutive conversions must result in values outside the interrupt window for an interrupt to be generated. For example, if N is equal to 10 and the integration time is 402 ms, then an interrupt will not be generated unless the light level persists for more than 4 seconds outside the threshold.

The interrupt line goes active low and remains low until the interrupt is cleared by selecting the Special Function in the COMMAND register and writing a 0 to the Interrupt Clear field value.

To configure the interrupt as an end-of-conversion signal so that every ADC integration cycle generates an interrupt, the interrupt PERSIST field in the Interrupt Control Register (02h) is set to 0000b. An interrupt will be generated upon completion of each conversion. The interrupt threshold registers are ignored.

APPLICATION INFORMATION: SOFTWARE

System Considerations

There are three system design considerations to take into account when using this device:

- The initial Channel 0 and Channel 1 ADC values (14h~17h) after ADC_EN is asserted should be discarded because the first ADC values are affected by transients associated with the power up of the analog circuitry.
- It is recommended that the ADC_EN be disabled before changing the analog gain (GAIN) in the Analog register (07h) because the change will affect the integration in progress, yielding an indeterminate result.
- The integration time (ITIME) in the Timing register (01h) can be changed at any time; however, the change will take effect only upon completion of the current ALS cycle.

Regarding the first design consideration, there are several ways that the initial ADC values can be discarded. One option is to use the interrupt persistence (PERSIST) in the Interrupt Control register (02h) equal to 2 (0010b), such that an interrupt is generated after the second ADC cycle when the values are valid. To ensure an interrupt, the interrupt high and low threshold registers (03h~06h) can both be set to 0, which is the default value. Once the interrupt occurs, the interrupt thresholds and PERSIST can be modified as desired.

To ensure the shortest time in the initial ADC cycle, another option is to set ITIME to the minimum, assert ADC_EN, and then change ITIME to the preferred integration time. Clear the first interrupt produced by the minimum integration time cycle so subsequent interrupts are the result of the modified integration time.

For example code that satisfies the system considerations listed above, see TAOS Designer's Notebook Number 42: *TSL258x: Accurate ADC Readings after Enable*.

TSL2581, TSL2583 LIGHT-TO-DIGITAL CONVERTER

TAOS134A – JULY 2012

APPLICATION INFORMATION: SOFTWARE

Calculating Lux

The TSL258x is intended for use in ambient light detection applications such as display backlight control, where adjustments are made to display brightness or contrast based on the brightness of the ambient light, as perceived by the human eye. Conventional silicon detectors respond strongly to infrared light, which the human eye does not see. This can lead to significant error when the infrared content of the ambient light is high, such as with incandescent lighting, due to the difference between the silicon detector response and the brightness perceived by the human eye.

This problem is overcome in the TSL258x through the use of two photodiodes. One of the photodiodes (channel 0) is sensitive to both visible and infrared light, while the second photodiode (channel 1) is sensitive primarily to infrared light. An integrating ADC converts the photodiode currents to digital outputs. Channel 1 digital output is used to compensate for the effect of the infrared component of light on the channel 0 digital output. The ADC digital outputs from the two channels are used in a formula to obtain a value that approximates the human eye response in the commonly used Illuminance unit of Lux:

Chipscale Package

For CH1/CH0 = 0.00 to 0.25	$\text{Lux} = 0.105 \times \text{CH0} - 0.208 \times \text{CH1}$
For CH1/CH0 = 0.25 to 0.38	$\text{Lux} = 0.1088 \times \text{CH0} - 0.2231 \times \text{CH1}$
For CH1/CH0 = 0.38 to 0.45	$\text{Lux} = 0.0729 \times \text{CH0} - 0.1286 \times \text{CH1}$
For CH1/CH0 = 0.45 to 0.60	$\text{Lux} = 0.060 \times \text{CH0} - 0.10 \times \text{CH1}$
For CH1/CH0 > 0.60	$\text{Lux}/\text{CH0} = 0$

FN Package

For CH1/CH0 = 0.00 to 0.30	$\text{Lux} = 0.130 \times \text{CH0} - 0.240 \times \text{CH1}$
For CH1/CH0 = 0.30 to 0.38	$\text{Lux} = 0.1649 \times \text{CH0} - 0.3562 \times \text{CH1}$
For CH1/CH0 = 0.38 to 0.45	$\text{Lux} = 0.0974 \times \text{CH0} - 0.1786 \times \text{CH1}$
For CH1/CH0 = 0.45 to 0.54	$\text{Lux} = 0.062 \times \text{CH0} - 0.100 \times \text{CH1}$
For CH1/CH0 > 0.54	$\text{Lux}/\text{CH0} = 0$

The formulas shown above were obtained by optical testing with fluorescent and incandescent light sources, and apply only to open-air applications. Optical apertures (e.g. light pipes) will affect the incident light on the device.

Simplified Lux Calculation

Below is the argument and return value including source code (shown on following page) for calculating lux with the TSL2583FN. The source code is intended for embedded and/or microcontroller applications. All floating point arithmetic operations have been eliminated since embedded controllers and microcontrollers generally do not support these types of operations. Because floating point has been removed, scaling must be performed prior to calculating illuminance if the integration time is not 400 msec and/or if the gain is not 1x as denoted in the source code on the following pages.

```

//*****
//
// Copyright 2004–2008 TAOS, Inc.
//
// THIS CODE AND INFORMATION IS PROVIDED "AS IS" WITHOUT WARRANTY OF ANY
// KIND, EITHER EXPRESSED OR IMPLIED, INCLUDING BUT NOT LIMITED TO THE
// IMPLIED WARRANTIES OF MERCHANTABILITY AND/OR FITNESS FOR A PARTICULAR
// PURPOSE.
//
// Module Name:
// lux.cpp
//
//*****

#define LUX_SCALE 16 // scale by 2^16
#define RATIO_SCALE 9 // scale ratio by 2^9

//-----
// Integration time scaling factors
//-----

#define CH_SCALE 16 // scale channel values by 2^16
#define NOM_INTEG_CYCLE 148 // Nominal 400 ms integration. See Timing Register

//-----
// Gain scaling factors
//-----

#define CH0GAIN128X 107 // 128X gain scalar for Ch0
#define CH1GAIN128X 115 // 128X gain scalar for Ch1

//-----
// FN Package coefficients
//-----

// For Ch1/Ch0=0.00 to 0.30:
// Lux=0.130*Ch0-0.240*Ch1
//
// For Ch1/Ch0=0.30 to 0.38:
// Lux=0.1649*Ch0-0.3562*Ch1
//
// For Ch1/Ch0=0.38 to 0.45:
// Lux=0.0974*Ch0-0.1786*Ch1
//
// For Ch1/Ch0=0.45 to 0.54:
// Lux=0.062*Ch0-0.10*Ch1
//
// For Ch1/Ch0>0.54:
// Lux/Ch0=0
//-----

#define K1C 0x009A // 0.30 * 2^RATIO_SCALE
#define B1C 0x2148 // 0.130 * 2^LUX_SCALE
#define M1C 0x3d71 // 0.240 * 2^LUX_SCALE

#define K2C 0x00c3 // 0.38 * 2^RATIO_SCALE
#define B2C 0x2a37 // 0.1649 * 2^LUX_SCALE
#define M2C 0x5b30 // 0.3562 * 2^LUX_SCALE

#define K3C 0x00e6 // 0.45 * 2^RATIO_SCALE
#define B3C 0x18ef // 0.0974 * 2^LUX_SCALE
#define M3C 0x2db9 // 0.1786 * 2^LUX_SCALE

#define K4C 0x0114 // 0.54 * 2^RATIO_SCALE
#define B4C 0x0fdf // 0.062 * 2^LUX_SCALE
#define M4C 0x199a // 0.10 * 2^LUX_SCALE

#define K5C 0x0114 // 0.54 * 2^RATIO_SCALE
#define B5C 0x0000 // 0.00000 * 2^LUX_SCALE
#define M5C 0x0000 // 0.00000 * 2^LUX_SCALE

```

TSL2581, TSL2583 LIGHT-TO-DIGITAL CONVERTER

TAOS134A – JULY 2012

```
// lux equation approximation without floating point calculations
// Routine: unsigned int CalculateLux(unsigned int ch0, unsigned int ch0, int iType)
// Description: Calculate the approximate illuminance (lux) given the raw
//              channel values of the TSL2583. The equation is implemented
//              as a piece-wise linear approximation.
// Arguments:  unsigned int iGain - gain, where 0:1X, 1:8X, 2:16X, 3:128X
//              unsigned int tIntCycles - INTEG_CYCLES defined in Timing Register
//              unsigned int ch0 - raw channel value from channel 0 of TSL2583
//              unsigned int ch1 - raw channel value from channel 1 of TSL2583
//              unsigned int iType - package type (1:CS)
// Return:    unsigned int - the approximate illuminance (lux)
//
// unsigned int CalculateLux(unsigned int iGain, unsigned int tIntCycles, unsigned int ch0,
// unsigned int ch1, int iType)
// {
//     //-----
//     // first, scale the channel values depending on the gain and integration time
//     // 1X, 400ms is nominal setting
//
//     unsigned long chScale0;
//     unsigned long chScale1;
//     unsigned long channel1;
//     unsigned long channel0;
//
//     // No scaling if nominal integration (148 cycles or 400 ms) is used
//     if (tIntCycles == NOM_INTEG_CYCLE)
//         chScale0 = (1 << CH_SCALE);
//     else
//         chScale0 = (NOM_INTEG_CYCLE << CH_SCALE) / tIntCycles;
//
//     switch (iGain)
//     {
//     case 0: // 1x gain
//         chScale1 = chScale0;           // No scale. Nominal setting
//         break;
//     case 1: // 8x gain
//         chScale0 = chScale0 >> 3;     // Scale/multiply value by 1/8
//         chScale1 = chScale0;
//         break;
//     case 2: // 16x gain
//         chScale0 = chScale0 >> 4;     // Scale/multiply value by 1/16
//         chScale1 = chScale0;
//         break;
//     case 3: // 128x gain
//         chScale1 = chScale0 / CH1GAIN128X; //Ch1 gain correction factor applied
//         chScale0 = chScale0 / CH0GAIN128X; //Ch0 gain correction factor applied
//         break;
//     }
//
//     // scale the channel values
//     channel0 = (ch0 * chScale0) >> CH_SCALE;
//     channel1 = (ch1 * chScale1) >> CH_SCALE;
//     //-----
//
//     // find the ratio of the channel values (Channel1/Channel0)
//     // protect against divide by zero
```



```

unsigned long ratio1 = 0;
if (channel0 != 0) ratio1 = (channel1 << (RATIO_SCALE+1)) / channel0;
// round the ratio value
unsigned long ratio = (ratio1 + 1) >> 1;

// is ratio <= eachBreak?
unsigned int b, m;
switch (iType)
{
    case 1: // CS package
        if ((ratio >= 0) && (ratio <= K1C))
            {b=B1C; m=M1C;}
        else if (ratio <= K2C)
            {b=B2C; m=M2C;}
        else if (ratio <= K3C)
            {b=B3C; m=M3C;}
        else if (ratio <= K4C)
            {b=B4C; m=M4C;}
        else if (ratio > K5C)
            {b=B5C; m=M5C;}
        break;
}

unsigned long temp;
unsigned long lux;
temp = ((channel0 * b) - (channel1 * m));

// round lsb (2^(LUX_SCALE-1))
temp += (1 << (LUX_SCALE-1));
// strip off fractional portion
lux = temp >> LUX_SCALE;

return(lux);
}

```

ams AG
 Technical content still valid



APPLICATION INFORMATION: HARDWARE

Power Supply Decoupling and Application Hardware Circuit

The power supply lines must be decoupled with a 0.1 μF capacitor placed as close to the device package as possible (Figure 7). The bypass capacitor should have low effective series resistance (ESR) and low effective series inductance (ESI), such as the common ceramic types, which provide a low impedance path to ground at high frequencies to handle transient currents caused by internal logic switching.

Figure 3 shows how the 111 \times gain is impacted by the line inductance between the V_{DD} pin and the decoupling capacitor.

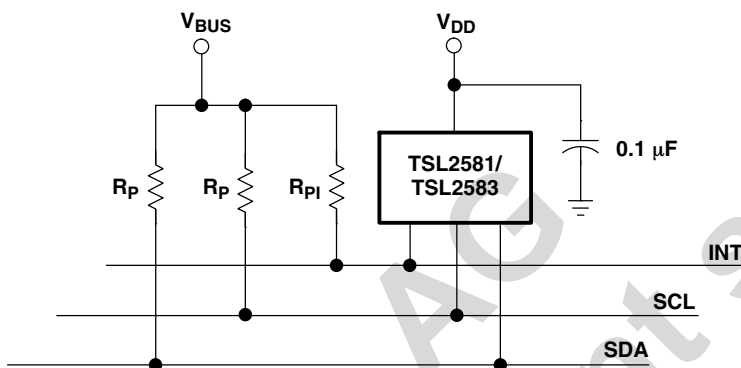

Figure 7. Bus Pull-Up Resistors

Pull-up resistors (R_P) maintain the SCL and SDA lines at a *high* level when the bus is free and ensure the signals are pulled up from a low to a high level within the required rise time. The I²C bus protocol was developed by Philips (now NXP). The pull-up resistor (R_P) value is a function of the I²C bus speed, the supply voltage, and the capacitive bus loading. Users should consult the NXP I²C design specification (<http://www.i2c-bus.org/references/>) for assistance. With a lightly loaded bus running at 400 kbps and $V_{\text{BUS}} = 3\text{ V}$, 1.5 k Ω resistors have been found to be viable.

A pull-up resistor (R_{PI}) is also required for the interrupt (INT), which functions as a wired-AND signal in a similar fashion to the SCL and SDA lines. A typical impedance value between 10 k Ω and 100 k Ω can be used.

APPLICATION INFORMATION: HARDWARE

PCB Pad Layouts

Suggested PCB pad layout guidelines for the CS chipscale package are shown in Figure 8.

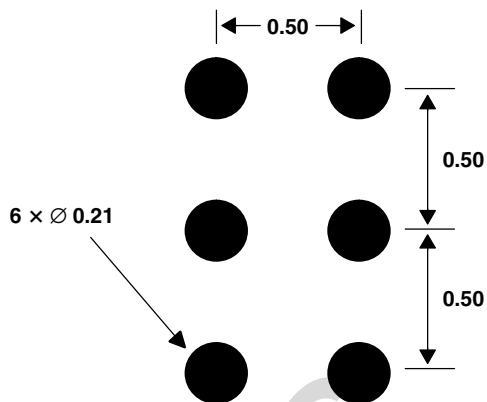

- NOTES: A. All linear dimensions are in millimeters.
B. This drawing is subject to change without notice.

Figure 8. Suggested CS Package PCB Layout

Suggested PCB pad layout guidelines for the Dual Flat No-Lead (FN) surface mount package are shown in Figure 9.

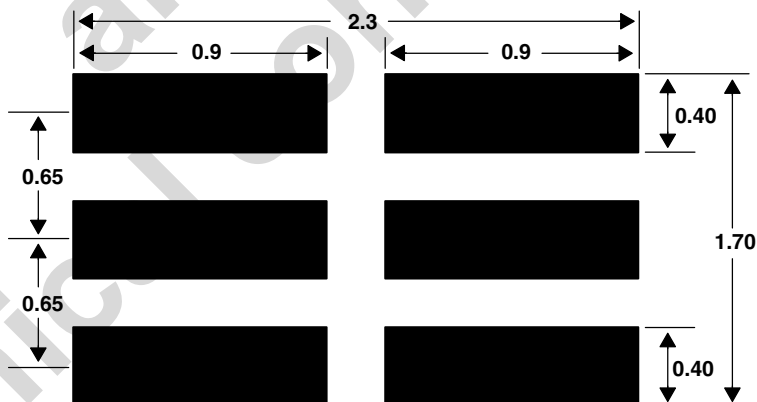

- NOTES: A. All linear dimensions are in millimeters.
B. This drawing is subject to change without notice.

Figure 9. Suggested FN Package PCB Layout

TSL2581, TSL2583 LIGHT-TO-DIGITAL CONVERTER

TAOS134A – JULY 2012

PACKAGE INFORMATION

PACKAGE CS

Six-Lead Chipscale

TOP VIEW

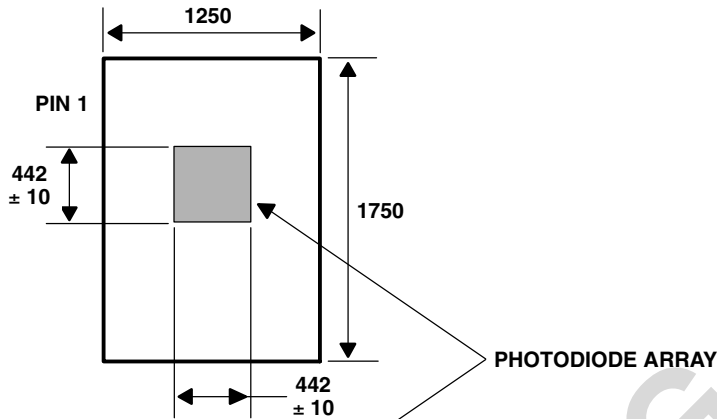

PIN OUT
BOTTOM VIEW

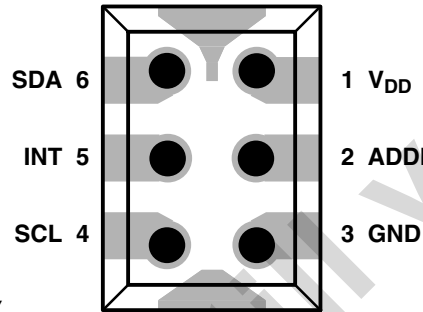

END VIEW

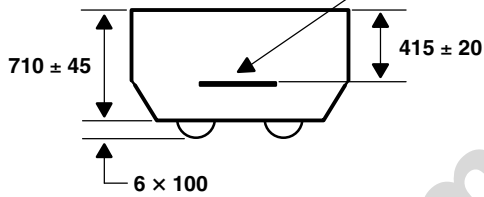

BOTTOM VIEW

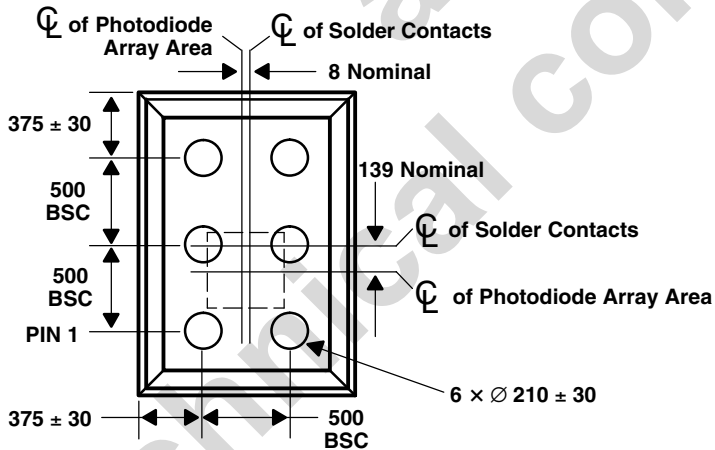

Lead Free

- NOTES: A. All linear dimensions are in micrometers. Dimension tolerance is $\pm 25 \mu\text{m}$ unless otherwise noted.
 B. Solder bumps are formed of Sn (96.5%), Ag (3%), and Cu (0.5%).
 C. The layer above the photodiode is glass and epoxy with an index of refraction of 1.53.
 D. This drawing is subject to change without notice.

Figure 10. Package CS — Six-Lead Chipscale Packaging Configuration

PACKAGE INFORMATION

PACKAGE FN

Dual Flat No-Lead

TOP VIEW

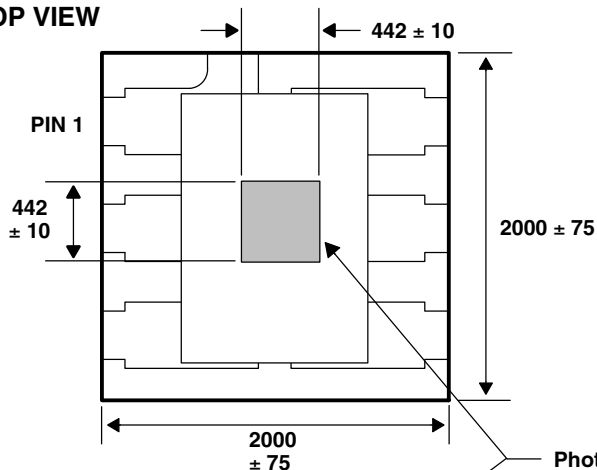

PIN OUT
TOP VIEW

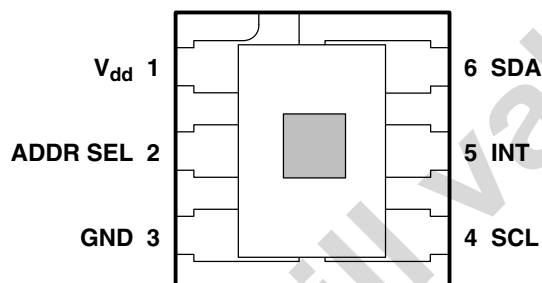

END VIEW

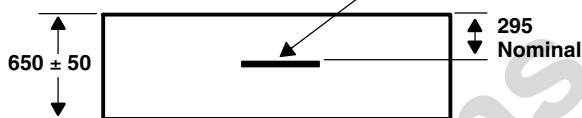

SIDE VIEW

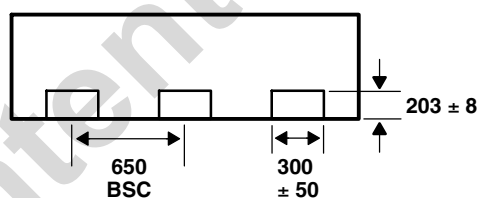

BOTTOM VIEW

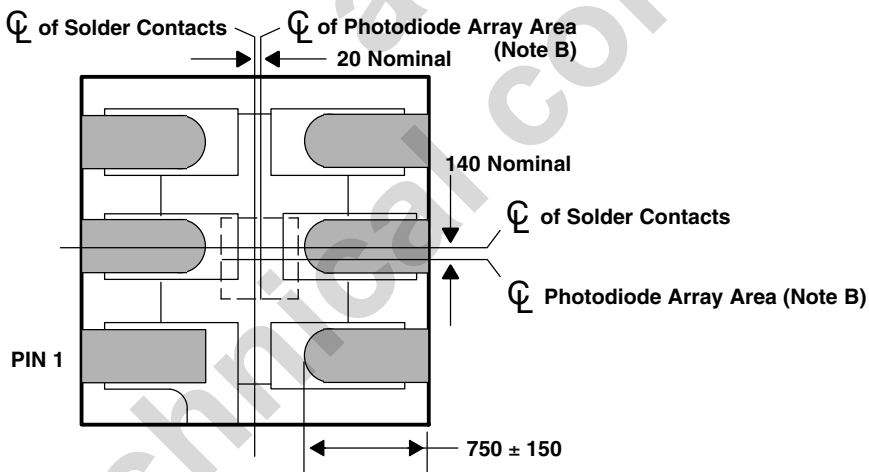

Lead Free

- NOTES: A. All linear dimensions are in micrometers. Dimension tolerance is $\pm 20 \mu\text{m}$ unless otherwise noted.
 B. The die is centered within the package within a tolerance of $\pm 75 \mu\text{m}$.
 C. Package top surface is molded with an electrically nonconductive clear plastic compound having an index of refraction of 1.55.
 D. Contact finish is copper alloy A194 with pre-plated NiPdAu lead finish.
 E. This package contains no lead (Pb).
 F. This drawing is subject to change without notice.

Figure 11. Package FN — Dual Flat No-Lead Packaging Configuration

TSL2581, TSL2583 LIGHT-TO-DIGITAL CONVERTER

TAOS134A – JULY 2012

CARRIER TAPE AND REEL INFORMATION

TOP VIEW

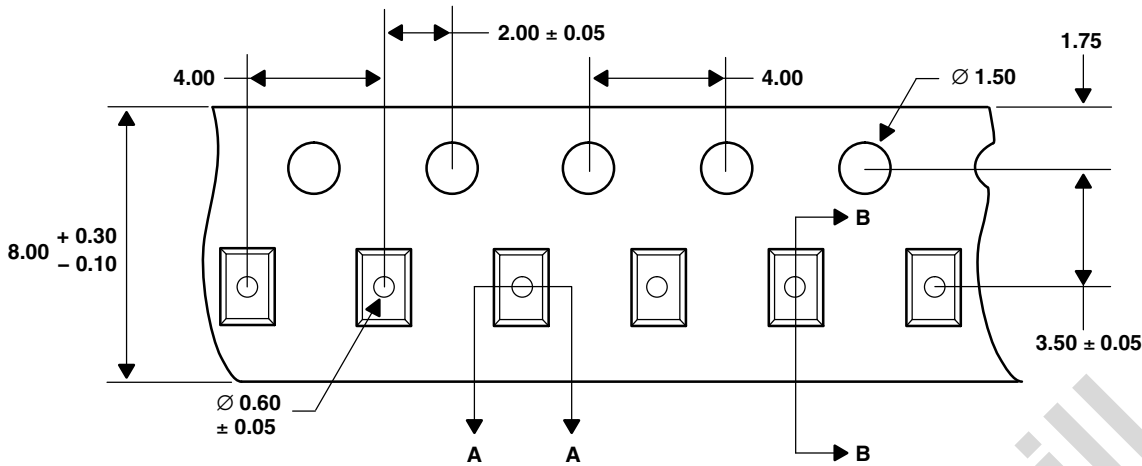

DETAIL A

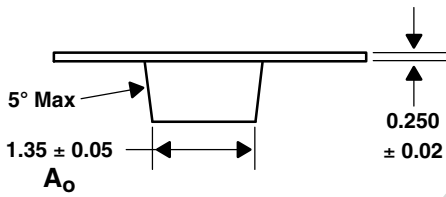

DETAIL B

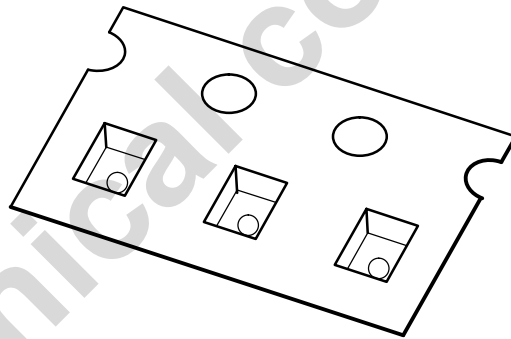
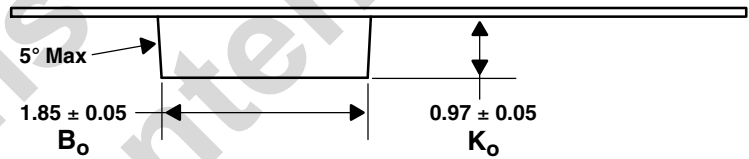

- NOTES:
- All linear dimensions are in millimeters. Dimension tolerance is ± 0.10 mm unless otherwise noted.
 - The dimensions on this drawing are for illustrative purposes only. Dimensions of an actual carrier may vary slightly.
 - Symbols on drawing A_o , B_o , and K_o are defined in ANSI EIA Standard 481-B 2001.
 - Each reel is 178 millimeters in diameter and contains 3500 parts.
 - TAOS packaging tape and reel conform to the requirements of EIA Standard 481-B.
 - In accordance with EIA standard, device pin 1 is located next to the sprocket holes in the tape.
 - This drawing is subject to change without notice.

Figure 12. Package CS Carrier Tape

CARRIER TAPE AND REEL INFORMATION

TOP VIEW

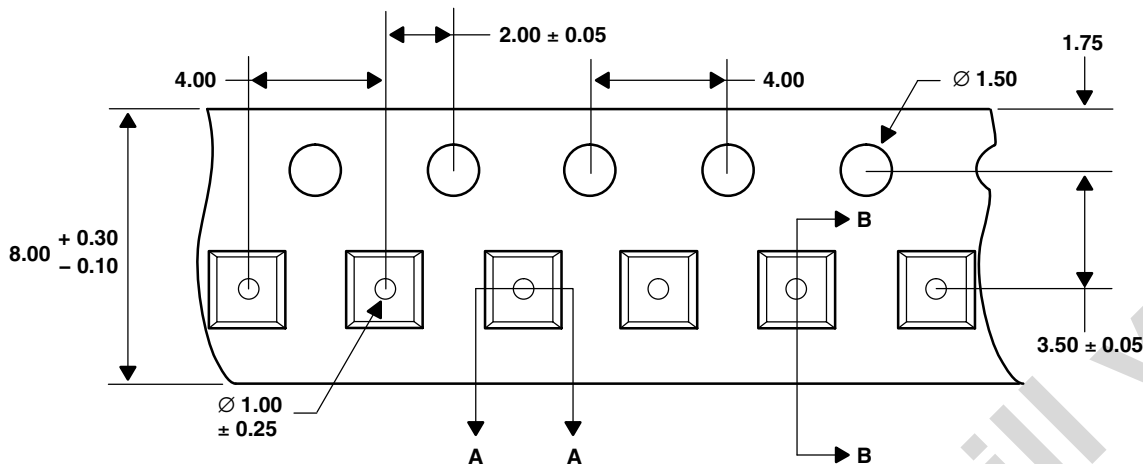

DETAIL A

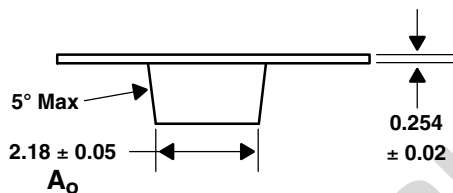

DETAIL B

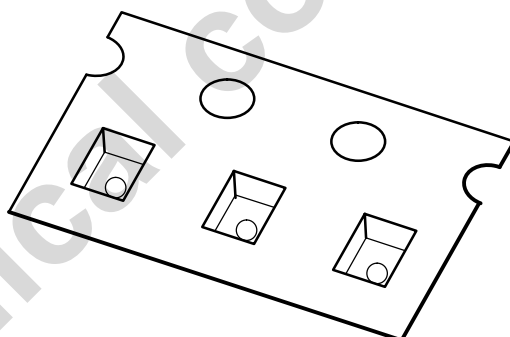
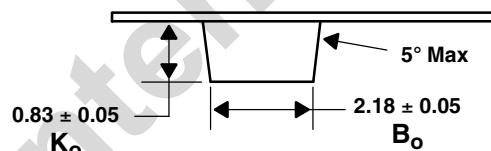

- NOTES: H. All linear dimensions are in millimeters. Dimension tolerance is ± 0.10 mm unless otherwise noted.
 I. The dimensions on this drawing are for illustrative purposes only. Dimensions of an actual carrier may vary slightly.
 J. Symbols on drawing A_o , B_o , and K_o are defined in ANSI EIA Standard 481-B 2001.
 K. Each reel is 178 millimeters in diameter and contains 3500 parts.
 L. TAOS packaging tape and reel conform to the requirements of EIA Standard 481-B.
 M. In accordance with EIA standard, device pin 1 is located next to the sprocket holes in the tape.
 N. This drawing is subject to change without notice.

Figure 13. Package FN Carrier Tape



SOLDERING INFORMATION

The package has been tested and have demonstrated an ability to be reflow soldered to a PCB substrate.

The solder reflow profile describes the expected maximum heat exposure of components during the solder reflow process of product on a PCB. Temperature is measured on top of component. The components should be limited to a maximum of three passes through this solder reflow profile.

Table 15. Solder Reflow Profile

PARAMETER	REFERENCE	DEVICE
Average temperature gradient in preheating		2.5°C/sec
Soak time	t_{soak}	2 to 3 minutes
Time above 217°C (T1)	t_1	Max 60 sec
Time above 230°C (T2)	t_2	Max 50 sec
Time above $T_{peak} - 10^\circ\text{C}$ (T3)	t_3	Max 10 sec
Peak temperature in reflow	T_{peak}	260° C (-0°C/+5°C)
Temperature gradient in cooling		Max -5°C/sec

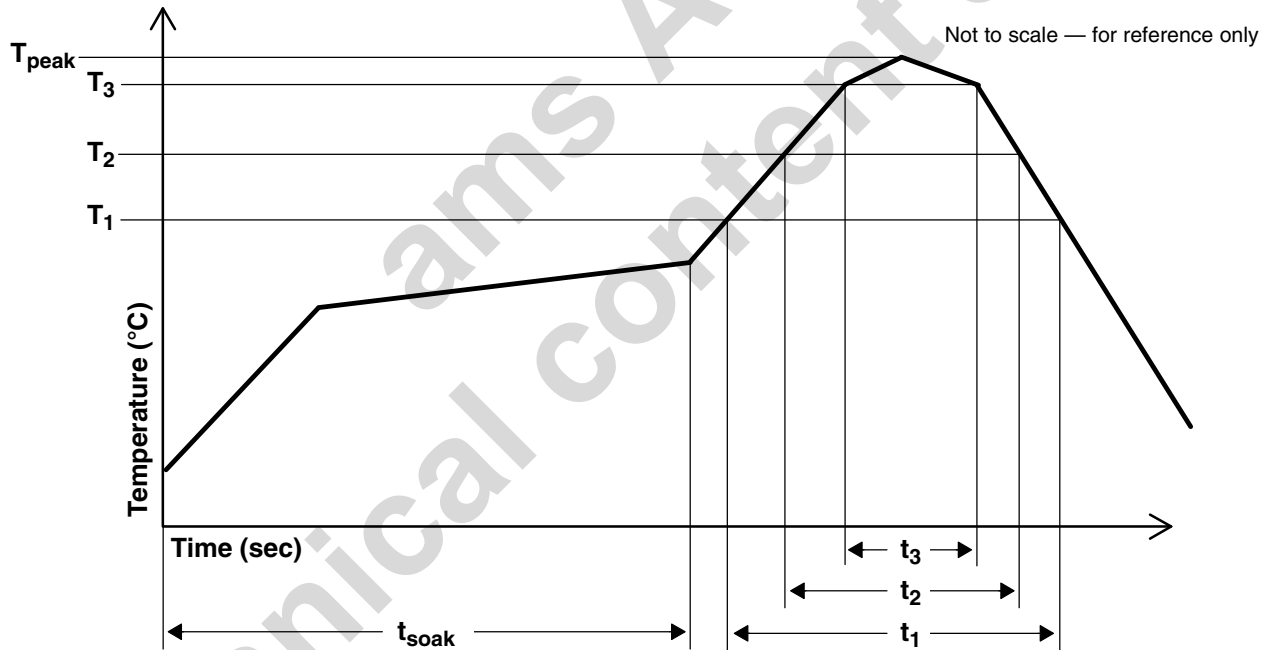

Figure 14. Solder Reflow Profile Graph

STORAGE INFORMATION

Moisture Sensitivity

Optical characteristics of the device can be adversely affected during the soldering process by the release and vaporization of moisture that has been previously absorbed into the package molding compound. To ensure the package molding compound contains the smallest amount of absorbed moisture possible, each device is dry-baked prior to being packed for shipping. Devices are packed in a sealed aluminized envelope with silica gel to protect them from ambient moisture during shipping, handling, and storage before use.

CS package

The CS package has been assigned a moisture sensitivity level of MSL 2 and the devices should be stored under the following conditions:

Temperature Range	5°C to 50°C
Relative Humidity	60% maximum
Floor Life	1 year out of bag at ambient < 30°C / 60% RH

Rebaking will be required if the aluminized envelope has been open for more than 1 year. If rebaking is required, it should be done at 50°C for 12 hours.

FN package

The FN package has been assigned a moisture sensitivity level of MSL 3 and the devices should be stored under the following conditions:

Temperature Range	5°C to 50°C
Relative Humidity	60% maximum
Total Time	12 months from the date code on the aluminized envelope — if unopened
Opened Time	168 hours or fewer

Rebaking will be required if the devices have been stored unopened for more than 12 months or if the aluminized envelope has been open for more than 168 hours. If rebaking is required, it should be done at 50°C for 12 hours.



TSL2581, TSL2583 LIGHT-TO-DIGITAL CONVERTER

TAOS134A – JULY 2012

PRODUCTION DATA — information in this document is current at publication date. Products conform to specifications in accordance with the terms of Texas Advanced Optoelectronic Solutions, Inc. standard warranty. Production processing does not necessarily include testing of all parameters.

LEAD-FREE (Pb-FREE) and GREEN STATEMENT

Pb-Free (RoHS) TAOS' terms *Lead-Free* or *Pb-Free* mean semiconductor products that are compatible with the current RoHS requirements for all 6 substances, including the requirement that lead not exceed 0.1% by weight in homogeneous materials. Where designed to be soldered at high temperatures, TAOS Pb-Free products are suitable for use in specified lead-free processes.

Green (RoHS & no Sb/Br) TAOS defines *Green* to mean Pb-Free (RoHS compatible), and free of Bromine (Br) and Antimony (Sb) based flame retardants (Br or Sb do not exceed 0.1% by weight in homogeneous material).

Important Information and Disclaimer The information provided in this statement represents TAOS' knowledge and belief as of the date that it is provided. TAOS bases its knowledge and belief on information provided by third parties, and makes no representation or warranty as to the accuracy of such information. Efforts are underway to better integrate information from third parties. TAOS has taken and continues to take reasonable steps to provide representative and accurate information but may not have conducted destructive testing or chemical analysis on incoming materials and chemicals. TAOS and TAOS suppliers consider certain information to be proprietary, and thus CAS numbers and other limited information may not be available for release.

NOTICE

Texas Advanced Optoelectronic Solutions, Inc. (TAOS) reserves the right to make changes to the products contained in this document to improve performance or for any other purpose, or to discontinue them without notice. Customers are advised to contact TAOS to obtain the latest product information before placing orders or designing TAOS products into systems.

TAOS assumes no responsibility for the use of any products or circuits described in this document or customer product design, conveys no license, either expressed or implied, under any patent or other right, and makes no representation that the circuits are free of patent infringement. TAOS further makes no claim as to the suitability of its products for any particular purpose, nor does TAOS assume any liability arising out of the use of any product or circuit, and specifically disclaims any and all liability, including without limitation consequential or incidental damages.

TEXAS ADVANCED OPTOELECTRONIC SOLUTIONS, INC. PRODUCTS ARE NOT DESIGNED OR INTENDED FOR USE IN CRITICAL APPLICATIONS IN WHICH THE FAILURE OR MALFUNCTION OF THE TAOS PRODUCT MAY RESULT IN PERSONAL INJURY OR DEATH. USE OF TAOS PRODUCTS IN LIFE SUPPORT SYSTEMS IS EXPRESSLY UNAUTHORIZED AND ANY SUCH USE BY A CUSTOMER IS COMPLETELY AT THE CUSTOMER'S RISK.

LUMENOLOGY, TAOS, the TAOS logo, and Texas Advanced Optoelectronic Solutions are registered trademarks of Texas Advanced Optoelectronic Solutions Incorporated.