



TXM-315-LC
TXM-418-LC
TXM-433-LC



LC SERIES TRANSMITTER MODULE DATA GUIDE

DESCRIPTION

The LC Series is ideally suited for volume use in OEM applications such as remote control, security, identification, and periodic data transfer. Housed in a compact surface-mount package, the LC Series transmitter utilizes a highly-optimized SAW architecture to achieve an unmatched blend of performance, size, efficiency, and cost. When paired with a matching LC Series or LR Series receiver, a highly reliable wireless link is formed, capable of transferring serial data at distances in excess of 300 feet (LC) or up to 3,000 feet (LR). No external RF components are required (except an antenna), making design and integration straightforward, even for engineers without previous RF experience.

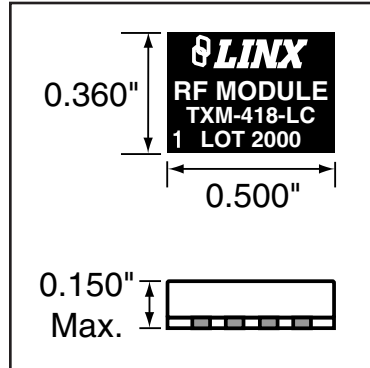

Figure 1: Package Dimensions

FEATURES

- Low cost
- No external RF components required
- Ultra-low power consumption
- Compact surface-mount package
- Stable SAW-based architecture
- Supports data rates to 5,000bps
- Wide supply range (2.7 to 5.2VDC)
- Direct serial interface
- Low harmonics
- No production tuning

APPLICATIONS INCLUDE

- Remote Control
- Keyless Entry
- Garage / Gate Openers
- Lighting Control
- Medical Monitoring / Call Systems
- Remote Industrial Monitoring
- Periodic Data Transfer
- Home / Industrial Automation
- Fire / Security Alarms
- Remote Status Sensing
- Long-Range RFID
- Wire Elimination

ORDERING INFORMATION

PART #	DESCRIPTION
TXM-315-LC	Transmitter 315MHz
TXM-418-LC	Transmitter 418MHz
TXM-433-LC	Transmitter 433MHz
RXM-315-LC	Receiver 315MHz
RXM-418-LC	Receiver 418MHz
RXM-433-LC	Receiver 433MHz
EVAL-***-LC	Basic Evaluation Kit
*** = Frequency	
Transmitters are supplied in tubes of 50 pcs.	

ELECTRICAL SPECIFICATIONS

Parameter	Designation	Min.	Typical	Max.	Units	Notes
POWER SUPPLY						
Operating Voltage	V_{CC}	2.7	–	5.2	VDC	–
Supply Current	I_{CC}	–	3.0	6.0	mA	1,4
Power-down Current	I_{PDN}	–	–	1.5	μ A	2
TRANSMITTER SECTION						
Transmit Frequency:	F_C					
TXM-315-LC		–	315	–	MHz	–
TXM-418-LC		–	418	–	MHz	–
TXM-433-LC		–	433.92	–	MHz	–
Center Frequency Accuracy	–	-50	–	+50	kHz	–
Output Power	P_o	-4	0	+4	dBm	3
Harmonic Emissions	P_H	–	–	-40	dBc	3
Data Rate	–	100	–	5,000	bps	–
Data Input:						
Logic Low	V_{IL}	0.0	–	0.4	VDC	–
Logic High	V_{IH}	2.5	–	V_{CC}	VDC	–
ANTENNA PORT						
RF Output Impedance	R_{OUT}	–	50	–	Ω	5
TIMING						
Transmitter Turn-On Time	–	–	30	80	μ Sec	5
Transmitter Turn-Off Time	–	–	–	100	nSec	5
ENVIRONMENTAL						
Operating Temperature Range	–	-30	–	+70	$^{\circ}$ C	5

Table 1: LC Series Transmitter Specifications

Notes

- Current draw with DATA pin held continuously high.
- Current draw with DATA pin low.
- RF out connected to a 50 Ω load.
- LADJ through 430 Ω resistor.
- Characterized, but not tested.

ABSOLUTE MAXIMUM RATINGS

Supply Voltage V_{CC}	-0.3	to	+6.0	VDC
Any Input or Output Pin	-0.3	to	V_{CC}	VDC
Operating Temperature	-30	to	+70	$^{\circ}$ C
Storage Temperature	-45	to	+85	$^{\circ}$ C
Soldering Temperature	+225 $^{\circ}$ C for 10 seconds			

NOTE Exceeding any of the limits of this section may lead to permanent damage to the device. Furthermore, extended operation at these maximum ratings may reduce the life of this device.

CAUTION

This product incorporates numerous static-sensitive components. Always wear an ESD wrist strap and observe proper ESD handling procedures when working with this device. Failure to observe this precaution may result in module damage or failure.

PERFORMANCE DATA

These performance parameters are based on module operation at 25 $^{\circ}$ C from a 3.3VDC supply unless otherwise noted. Figure 2 illustrates the connections necessary for testing and operation. It is recommended all ground pins be connected to the ground plane.

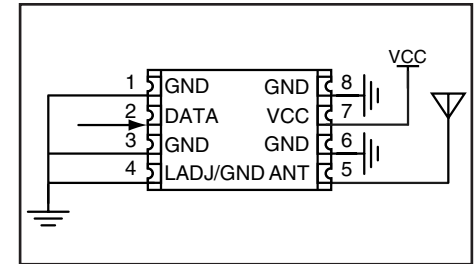

Figure 2: Test / Basic Application Circuit

TYPICAL PERFORMANCE GRAPHS

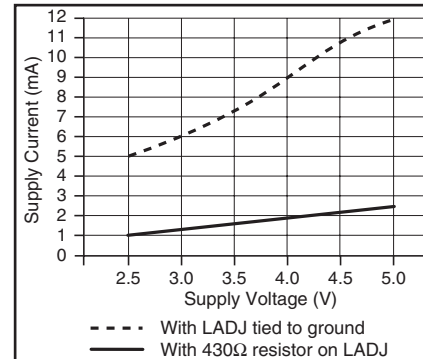

Figure 3: Current vs. Supply Voltage

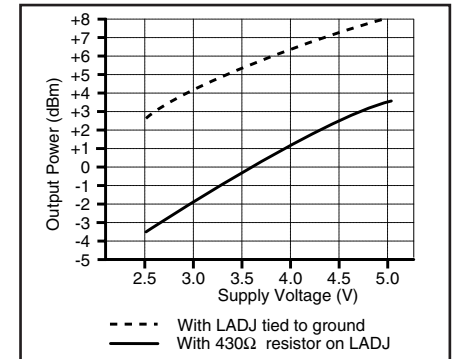

Figure 4: Output Power vs. Supply Voltage

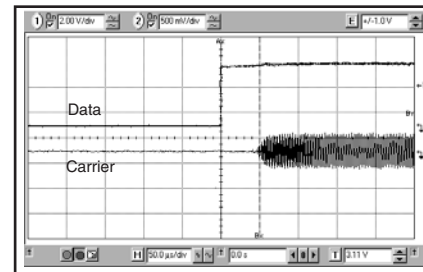

Figure 5: Typical Oscillator Turn-On Time

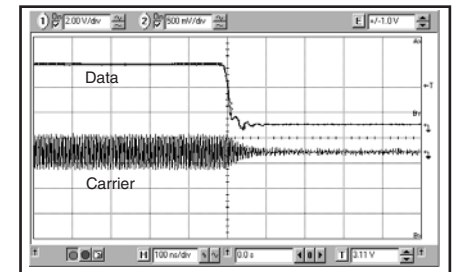

Figure 6: Typical Oscillator Turn-Off Time

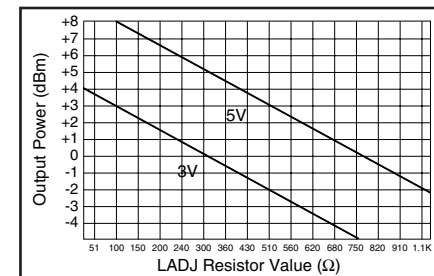

Figure 7: Output Power vs. LADJ Resistor

PIN ASSIGNMENTS

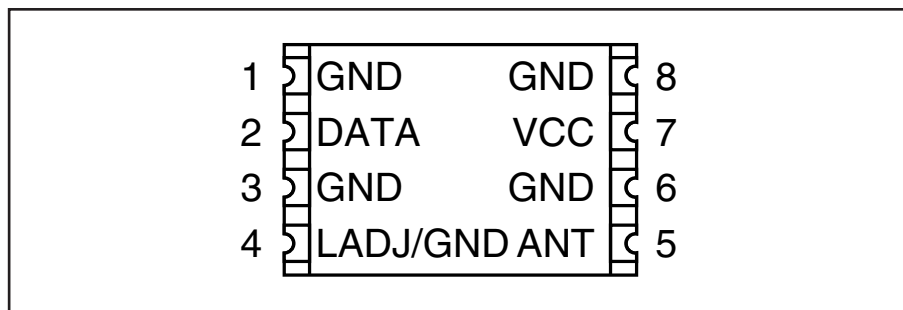

Figure 8: LC Series Transmitter Pinout (Top View)

PIN DESCRIPTIONS

Pin #	Name	Description
1	GND	Analog Ground
2	DATA	Digital Data Input
3	GND	Analog Ground
4	LADJ/GND	Level Adjust. This line can be used to adjust the output power level of the transmitter. Connecting to ground will give the highest output, while placing a resistor to ground will lower the output level (see Figure 7 on Page 3).
5	ANT	50-ohm RF Output
6	GND	Analog Ground
7	V _{CC}	Supply Voltage
8	GND	Analog Ground

MODULE DESCRIPTION

The LC Series transmitter is a low-cost, high-performance Surface Acoustic Wave (SAW) based Carrier-Present Carrier-Absent (CPCA) transmitter capable of sending serial data at up to 5,000bps. The LC's compact surface-mount package integrates easily into existing designs and is equally friendly to prototype and volume production. The LC's ultra-low power consumption makes it ideally suited for battery-powered products. When combined with a Linx LC or LR Series receiver, a reliable RF link is formed, capable of transferring data over line-of-sight distances in excess of 300 feet (with the LC Series receiver) or up to 3,000 feet (with the LR Series receiver).

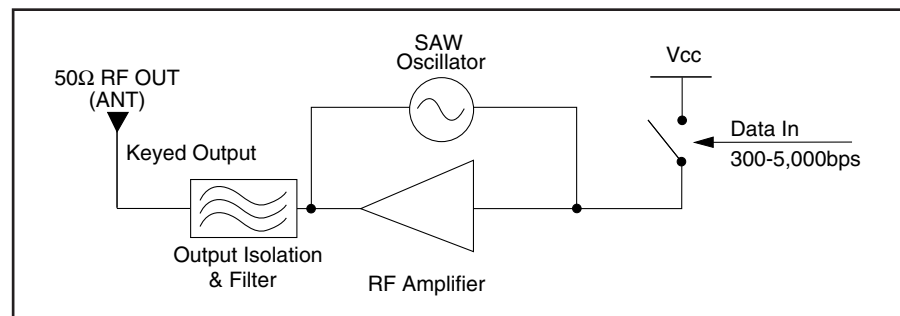

Figure 9: LC Series Transmitter Block Diagram

THEORY OF OPERATION

The LC Series transmitter transmits data using Carrier-Present Carrier-Absent (CPCA) modulation. This type of AM modulation is often referred to by other designations, including Continuous Wave (CW) and On-Off Key (OOK). This type of modulation represents a logic low '0' by the absence of a carrier and a logic high '1' by the presence of a carrier. This method affords numerous benefits. Three of the most important are:

- 1) Cost-effectiveness due to design simplicity.
- 2) No minimum data rate or mark / space ratio requirement.
- 3) Higher output power and thus greater range in countries (such as the U.S.) where output power measurements are averaged over time. (Please refer to Linx Application Note AN-00130).

The LC Series transmitter is based on a simple but highly optimized architecture that achieves a high fundamental output power with low harmonic content. This ensures that approval requirements can be met without external filter components. The LC Series transmitter is exceptionally stable over time, temperature, and physical shock as a result of the precision Surface Acoustic Wave (SAW) frequency reference. Due to the accuracy of the SAW device, most of the output power is concentrated in a narrow bandwidth. This allows the receiver's bandwidth to be quite narrow, thus increasing sensitivity and reducing susceptibility to near-band interference. The quality of components and overall architecture utilized in the LC Series is extraordinary in a low-cost RF device and is one reason the LC transmitter is able to outperform more expensive products.

THE DATA INPUT

A CMOS / TTL level data input is provided on Pin 2. This line is normally supplied with a serial bitstream input directly from a microprocessor, encoder, or UART. During standby, or the input of a logic low, the carrier is fully suppressed and the transmitter consumes less than $2\mu\text{A}$ of current. During a logic high, the transmitter generates a carrier to indicate to the receiver the presence of a logic '1'. The applied data should not exceed a rate of 5,000bps. The data input line should always be driven with a voltage common to the supply voltage present on Pin 7 (V_{CC}) and should never be allowed to exceed the supply voltage.

ADJUSTING THE OUTPUT POWER

Depending on the type of antenna being used and the duty cycle of the data, the output power of the LC Series transmitter module may be higher than FCC regulations allow. The output power of the module is intentionally set high to compensate for losses resulting from inefficient antennas that may be used to realize cost or space savings. Since attenuation is often required, it is generally wise to provide for its implementation and allow the FCC test lab to easily attenuate the transmitter to the maximum legal limit for your product.

Two methods of attenuation are available using the LC Series transmitter module. First, a resistor may be placed between Pin 4 (LADJ) and ground to achieve up to a 7dB reduction in output power. The resistor value is easily determined from Figure 7 on Page 3. Do not exceed the resistance values shown as transmitter instability may result. This method can also be used to reduce the transmission range and power consumption.

Another method commonly used to achieve attenuation, particularly at higher levels, is the use of a T-pad attenuator. A T-pad is a network of three resistors that allows for variable attenuation while maintaining the correct match to the antenna. It is usually prudent to allow space for the addition of a T-pad. An example of a T-pad attenuator layout is shown in the figure below. For further details on T-pad attenuators, please refer to Application Note AN-00150.

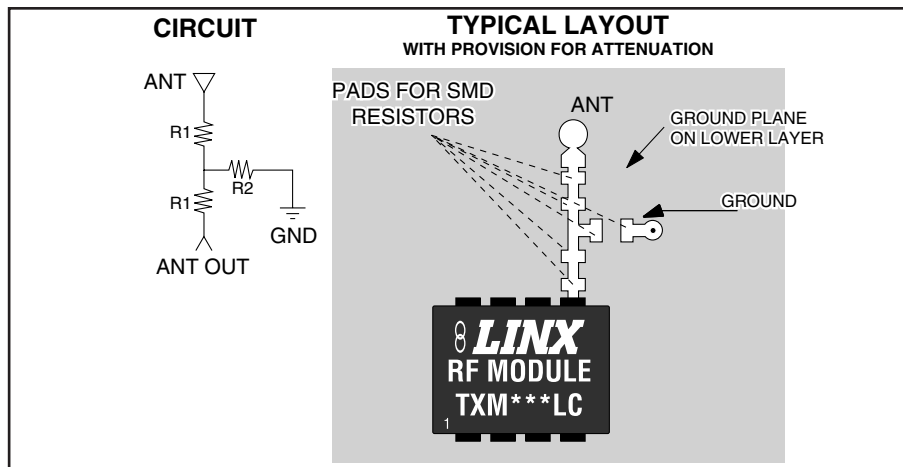

Figure 10: A T-Pad Attenuator Layout Example

POWER SUPPLY REQUIREMENTS

The module does not have an internal voltage regulator; therefore it requires a clean, well-regulated power source. While it is preferable to power the unit from a battery, the unit can also be operated from a power supply as long as noise is less than 20mV. Power supply noise can significantly affect the transmitter modulation; therefore, providing a clean power supply for the module should be a high design priority.

A 10Ω resistor in series with the supply followed by a $10\mu\text{F}$ tantalum capacitor from V_{CC} to ground will help in cases where the quality of supply power is poor. These values may need to be adjusted depending on the noise present on the supply line.

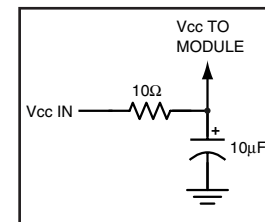

Figure 11: Supply Filter

TRANSMITTING DATA

Once a reliable RF link has been established, the challenge becomes how to effectively transfer data across it. While a properly designed RF link provides reliable data transfer under most conditions, there are still distinct differences from a wired link that must be addressed. Since the LC Series modules do not incorporate internal encoding or decoding, a user has tremendous flexibility in how data is handled.

If you want to transfer simple control or status signals, such as button presses or switch closures, and your product does not have a microprocessor on board, or you wish to avoid protocol development, consider using an encoder and decoder IC set. These chips are available from a range of manufacturers, including Linx. They take care of all encoding and decoding functions and generally provide a number of data pins to which switches can be directly connected. In addition, address bits are usually provided for security and to allow the addressing of multiple units independently. These ICs are an excellent way to bring basic remote control / status products to market quickly and inexpensively. Additionally, it is a simple task to interface with inexpensive microprocessors, such as the Microchip PIC, or one of many IR, remote control, or modem ICs.

It is always important to separate what types of transmissions are technically possible from those that are legally allowable in the country of intended operation. While the LR Series is ideally suited to the long range transfer of control and command information, it can also be used with great success for the transfer of true variable data such as temperature, pressure, or sensor data. However, the 260 - 470MHz band in which the module operates is regulated by Part 15, Section 231 of the FCC regulations. Many types of transmissions, especially those involving automatic transmissions or variable data, may need to be periodic. You may wish to review Application Notes AN-00125 and AN-00140 along with Part 15, Section 231 of the FCC regulations for further details on acceptable transmission content in the United States.

Another area of consideration is that of data structure or protocol. The data should be formatted in a predictable way and should be able to deal with errors due to interference. This will ensure that the data is received and interpreted correctly. If you are not familiar with the considerations for sending serial data in a wireless environment, you will want to review Application Note AN-00160.

BOARD LAYOUT GUIDELINES

If you are at all familiar with RF devices, you may be concerned about specialized board layout requirements. Fortunately, because of the care taken by Linx in designing the modules, integrating them is very straightforward. Despite this ease of application, it is still necessary to maintain respect for the RF stage and exercise appropriate care in layout and application in order to maximize performance and ensure reliable operation. The antenna can also be influenced by layout choices. Please review this data guide in its entirety prior to beginning your design. By adhering to good layout principles and observing some basic design rules, you will be on the path to RF success.

The adjacent figure shows the suggested PCB footprint for the module. The actual pad dimensions are shown in the Pad Layout section of this manual. A ground plane (as large as possible) should be placed on a lower layer of your PC board opposite the module. This ground plane can also be critical to the performance of your antenna, which will be discussed later. There should not be any ground or traces under the module on the same layer as the module, just bare PCB.

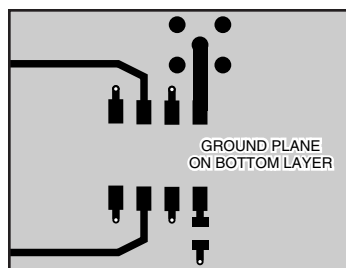

Figure 13: Suggested PCB Layout

During prototyping, the module should be soldered to a properly laid-out circuit board. The use of prototyping or “perf” boards will result in horrible performance and is strongly discouraged.

No conductive items should be placed within 0.15in of the module’s top or sides.

Do not route PCB traces directly under the module. The underside of the module has numerous signal-bearing traces and vias that could short or couple to traces on the product’s circuit board.

The module’s ground lines should each have their own via to the ground plane and be as short as possible.

AM / OOK receivers are particularly subject to noise. The module should, as much as reasonably possible, be isolated from other components on your PCB, especially high-frequency circuitry such as crystal oscillators, switching power supplies, and high-speed bus lines. Make sure internal wiring is routed away from the module and antenna, and is secured to prevent displacement.

The power supply filter should be placed close to the module’s V_{CC} line.

In some instances, a designer may wish to encapsulate or “pot” the product. Many Linx customers have done this successfully; however, there are a wide variety of potting compounds with varying dielectric properties. Since such compounds can considerably impact RF performance, it is the responsibility of the designer to carefully evaluate and qualify the impact and suitability of such materials.

The trace from the module to the antenna should be kept as short as possible. A simple trace is suitable for runs up to 1/8-inch for antennas with wide bandwidth characteristics. For longer runs or to avoid detuning narrow bandwidth antennas, such as a helical, use a 50-ohm coax or 50-ohm microstrip transmission line as described in the following section.

MICROSTRIP DETAILS

A transmission line is a medium whereby RF energy is transferred from one place to another with minimal loss. This is a critical factor, especially in high-frequency products like Linx RF modules, because the trace leading to the module’s antenna can effectively contribute to the length of the antenna, changing its resonant bandwidth. In order to minimize loss and detuning, some form of transmission line between the antenna and the module should be used, unless the antenna can be placed very close (<1/8in.) to the module. One common form of transmission line is a coax cable, another is the microstrip. This term refers to a PCB trace running over a ground plane that is designed to serve as a transmission line between the module and the antenna. The width is based on the desired characteristic impedance of the line, the thickness of the PCB, and the dielectric constant of the board material. For standard 0.062in thick FR-4 board material, the trace width would be 111 mils. The correct trace width can be calculated for other widths and materials using the information below. Handy software for calculating microstrip lines is also available on the Linx website, www.linxtechnologies.com.

$$E_e = \frac{E_r + 1}{2} + \frac{E_r - 1}{2} \cdot \frac{1}{\sqrt{1 + 12d/W}}$$

$$Z_0 = \begin{cases} \frac{60}{\sqrt{E_e}} \cdot \ln\left(\frac{8d}{W} + \frac{W}{4d}\right) & \text{For } \frac{W}{d} \leq 1 \\ \frac{120\pi}{\sqrt{E_e} \cdot \left(\frac{W}{d} + 1.393 + 0.667 \cdot \ln\left(\frac{W}{d} + 1.444\right)\right)} & \text{For } \frac{W}{d} \geq 1 \end{cases}$$

E_r = Dielectric constant of PCB material

Figure 12: Microstrip Formulas

Dielectric Constant	Width/Height (W/d)	Effective Dielectric Constant	Characteristic Impedance
4.80	1.8	3.59	50.0
4.00	2.0	3.07	51.0
2.55	3.0	2.12	48.0

PAD LAYOUT

The following pad layout diagram is designed to facilitate both hand and automated assembly.

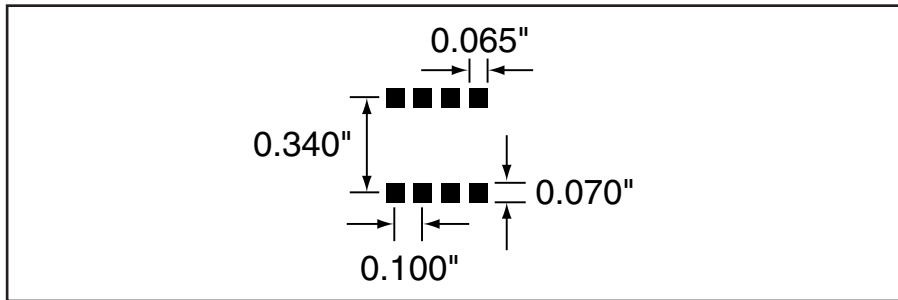

Figure 15: Recommended PCB Layout

PRODUCTION GUIDELINES

The modules are housed in a hybrid SMD package that supports hand or automated assembly techniques. Since the modules contain discrete components internally, the assembly procedures are critical to ensuring the reliable function of the modules. The following procedures should be reviewed with and practiced by all assembly personnel.

HAND ASSEMBLY

Pads located on the bottom of the module are the primary mounting surface. Since these pads are inaccessible during mounting, castellations that run up the side of the module have been provided to facilitate solder wicking to the module's underside. This allows for very quick hand soldering for prototyping and small volume production.

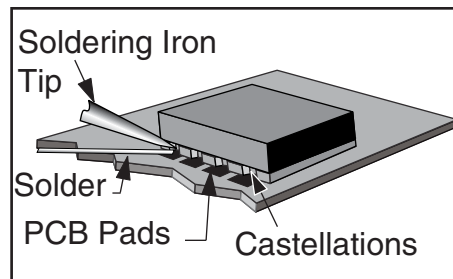

Figure 16: Soldering Technique

If the recommended pad guidelines have been followed, the pads will protrude slightly past the edge of the module. Use a fine soldering tip to heat the board pad and the castellation, then introduce solder to the pad at the module's edge. The solder will wick underneath the module, providing reliable attachment. Tack one module corner first and then work around the device, taking care not to exceed the times listed below.

Absolute Maximum Solder Times

Hand-Solder Temp. TX +225°C for 10 Seconds

Hand-Solder Temp. RX +225°C for 10 Seconds

Recommended Solder Melting Point +180°C

Reflow Oven: +220°C Max. (See adjoining diagram)

AUTOMATED ASSEMBLY

For high-volume assembly, most users will want to auto-place the modules. The modules have been designed to maintain compatibility with reflow processing techniques; however, due to their hybrid nature, certain aspects of the assembly process are far more critical than for other component types.

Following are brief discussions of the three primary areas where caution must be observed.

Reflow Temperature Profile

The single most critical stage in the automated assembly process is the reflow stage. The reflow profile below should not be exceeded, since excessive temperatures or transport times during reflow will irreparably damage the modules. Assembly personnel will need to pay careful attention to the oven's profile to ensure that it meets the requirements necessary to successfully reflow all components while still remaining within the limits mandated by the modules. The figure below shows the recommended reflow oven profile for the modules.

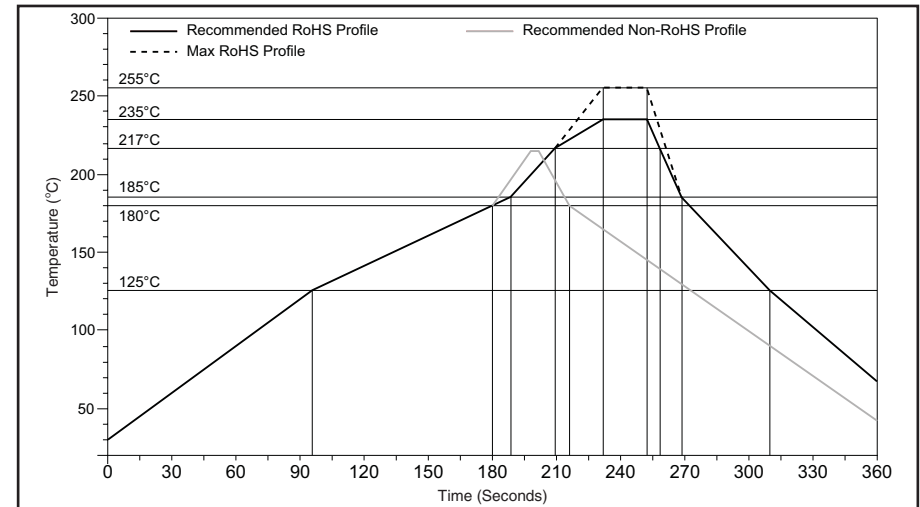

Figure 17: Maximum Reflow Profile

Shock During Reflow Transport

Since some internal module components may reflow along with the components placed on the board being assembled, it is imperative that the modules not be subjected to shock or vibration during the time solder is liquid. Should a shock be applied, some internal components could be lifted from their pads, causing the module to not function properly.

Washability

The modules are wash resistant, but are not hermetically sealed. Linx recommends wash-free manufacturing; however, the modules can be subjected to a wash cycle provided that a drying time is allowed prior to applying electrical power to the modules. The drying time should be sufficient to allow any moisture that may have migrated into the module to evaporate, thus eliminating the potential for shorting damage during power-up or testing. If the wash contains contaminants, the performance may be adversely affected, even after drying.

ANTENNA CONSIDERATIONS

The choice of antennas is a critical and often overlooked design consideration. The range, performance, and legality of an RF link are critically dependent upon the antenna. While adequate antenna performance can often be obtained by trial and error methods, antenna design and matching is a complex task. A professionally designed antenna, such as those from Linx, will help ensure maximum performance and FCC compliance.

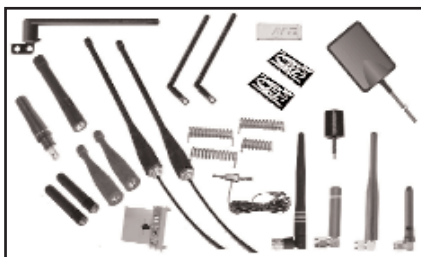

Figure 18: Linx Antennas

Linx transmitter modules typically have an output power that is slightly higher than the legal limits. This allows the designer to use an inefficient antenna, such as a loop trace or helical, to meet size, cost, or cosmetic requirements and still achieve full legal output power for maximum range. If an efficient antenna is used, then some attenuation of the output power will likely be needed. This can easily be accomplished by using the LADJ line or a T-pad attenuator. For more details on T-pad attenuator design, please see Application Note AN-00150.

A receiver antenna should be optimized for the frequency or band in which the receiver operates and to minimize the reception of off-frequency signals. The efficiency of the receiver's antenna is critical to maximizing range performance. Unlike the transmitter antenna, where legal operation may mandate attenuation or a reduction in antenna efficiency, the receiver's antenna should be optimized as much as is practical.

It is usually best to utilize a basic quarter-wave whip until your prototype product is operating satisfactorily. Other antennas can then be evaluated based on the cost, size, and cosmetic requirements of the product. You may wish to review Application Note AN-00500 "Antennas: Design, Application, Performance"

ANTENNA SHARING

In cases where a transmitter and receiver module are combined to form a transceiver, it is often advantageous to share a single antenna. To accomplish this, an antenna switch must be used to provide isolation between the modules so that the full transmitter output power is not put on the sensitive front end of the receiver. There are a wide variety of antenna switches that are cost-effective and easy to use. Among the most popular are switches from Macom and NEC. Look for an antenna switch that has high isolation and low loss at the desired frequency of operation. Generally, the Tx or Rx status of a switch will be controlled by a product's microprocessor, but the user may also make the selection manually. In some cases, where the characteristics of the Tx and Rx antennas need to be different or antenna switch losses are unacceptable, it may be more appropriate to utilize two discrete antennas.

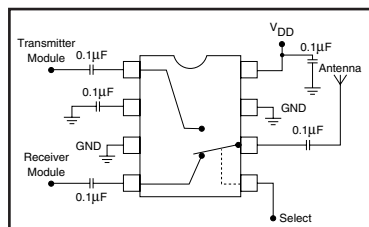

Figure 19: Typical Antenna Switch

GENERAL ANTENNA RULES

The following general rules should help in maximizing antenna performance.

1. Proximity to objects such as a user's hand, body, or metal objects will cause an antenna to detune. For this reason, the antenna shaft and tip should be positioned as far away from such objects as possible.

2. Optimum performance will be obtained from a 1/4- or 1/2-wave straight whip mounted at a right angle to the ground plane. In many cases, this isn't desirable for practical or ergonomic reasons, thus, an alternative antenna style such as a helical, loop, or patch may be utilized

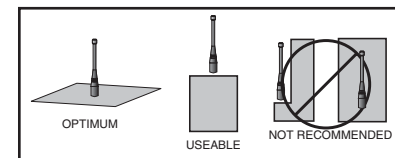

Figure 20: Ground Plane Orientation and the corresponding sacrifice in performance accepted.

3. If an internal antenna is to be used, keep it away from other metal components, particularly large items like transformers, batteries, PCB tracks, and ground planes. In many cases, the space around the antenna is as important as the antenna itself. Objects in close proximity to the antenna can cause direct detuning, while those farther away will alter the antenna's symmetry.

4. In many antenna designs, particularly 1/4-wave whips, the ground plane acts as a counterpoise, forming, in essence, a 1/2-wave dipole. For this reason, adequate ground plane area is essential. The ground plane can be a metal case or ground-fill areas on a circuit board. Ideally, it should have a surface area \geq the overall length of the 1/4-wave radiating element. This is often not practical due to size and configuration constraints. In these instances, a designer must make the best use of the area available to create as much ground plane as possible in proximity to the base of the antenna. In cases where the antenna is remotely located or the antenna is not in close proximity to a circuit board, ground plane, or grounded metal case, a metal plate may be used to maximize the antenna's performance.

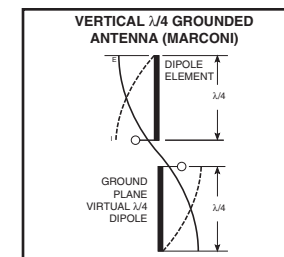

Figure 21: Dipole Antenna

5. Remove the antenna as far as possible from potential interference sources. Any frequency of sufficient amplitude to enter the receiver's front end will reduce system range and can even prevent reception entirely. Switching power supplies, oscillators, or even relays can also be significant sources of potential interference. The single best weapon against such problems is attention to placement and layout. Filter the module's power supply with a high-frequency bypass capacitor. Place adequate ground plane under potential sources of noise to shunt noise to ground and prevent it from coupling to the RF stage. Shield noisy board areas whenever practical.

6. In some applications, it is advantageous to place the module and antenna away from the main equipment. This can avoid interference problems and allows the antenna to be oriented for optimum performance. Always use 50Ω coax, like RG-174, for the remote feed.

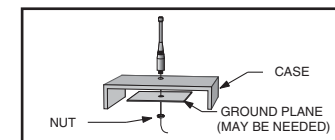

Figure 22: Remote Ground Plane

COMMON ANTENNA STYLES

There are literally hundreds of antenna styles and variations that can be employed with Linx RF modules. Following is a brief discussion of the styles most commonly utilized. Additional antenna information can be found in Linx Application Notes AN-00100, AN-00140, and AN-00500. Linx antennas and connectors offer outstanding performance at a low price.

Whip Style



A whip-style antenna provides outstanding overall performance and stability. A low-cost whip is can be easily fabricated from a wire or rod, but most designers opt for the consistent performance and cosmetic appeal of a professionally-made model. To meet this need, Linx offers a wide variety of straight and reduced-height whip-style antennas in permanent and connectorized mounting styles.

The wavelength of the operational frequency determines an antenna's overall length. Since a full wavelength is often quite long, a partial 1/2- or 1/4-wave antenna is normally employed. Its size and natural radiation resistance make it well matched to Linx modules. The proper length for a straight 1/4-wave can be easily determined using the adjacent formula. It is also possible to reduce the overall height of the antenna by using a helical winding. This reduces the antenna's bandwidth, but is a great way to minimize the antenna's physical size for compact applications. This also means that the physical appearance is not always an indicator of the antenna's frequency.

$$L = \frac{234}{F} \text{ MHz}$$

Where:
L = length in feet of quarter-wave length
F = operating frequency in megahertz

Specialty Styles



Linx offers a wide variety of specialized antenna styles. Many of these styles utilize helical elements to reduce the overall antenna size while maintaining reasonable performance. A helical antenna's bandwidth is often quite narrow and the antenna can detune in proximity to other objects, so care must be exercised in layout and placement.

Loop Style



A loop- or trace-style antenna is normally printed directly on a product's PCB. This makes it the most cost-effective of antenna styles. The element can be made self-resonant or externally resonated with discrete components, but its actual layout is usually product specific. Despite the cost advantages, loop-style antennas are generally inefficient and useful only for short-range applications. They are also very sensitive to changes in layout and PCB dielectric, which can cause consistency issues during production. In addition, printed styles are difficult to engineer, requiring the use of expensive equipment, including a network analyzer. An improperly designed loop will have a high SWR at the desired frequency, which can cause instability in the RF stage.



Linx offers low-cost planar and chip antennas that mount directly to a product's PCB. These tiny antennas do not require testing and provide excellent performance in light of their small size. They offer a preferable alternative to the often-problematic "printed" antenna.

ONLINE RESOURCES



www.linxtechnologies.com

- Latest News
- Data Guides
- Application Notes
- Knowledgebase
- Software Updates



If you have questions regarding any Linx product and have Internet access, make www.linxtechnologies.com your first stop. Our website is organized in an intuitive format to immediately give you the answers you need. Day or night, the Linx website gives you instant access to the latest information regarding the products and services of Linx. It's all here: manual and software updates, application notes, a comprehensive knowledgebase, FCC information, and much more. Be sure to visit often!



www.antennafactor.com

The Antenna Factor division of Linx offers a diverse array of antenna styles, many of which are optimized for use with our RF modules. From innovative embeddable antennas to low-cost whips, domes to Yagis, and even GPS, Antenna Factor likely has an antenna for you, or can design one to meet your requirements.



www.connectorcity.com

Through its Connector City division, Linx offers a wide selection of high-quality RF connectors, including FCC-compliant types such as RP-SMAs that are an ideal match for our modules and antennas. Connector City focuses on high-volume OEM requirements, which allows standard and custom RF connectors to be offered at a remarkably low cost.



LEGAL CONSIDERATIONS

NOTE: Linx RF modules are designed as component devices that require external components to function. The modules are intended to allow for full Part 15 compliance; however, they are not approved by the FCC or any other agency worldwide. The purchaser understands that approvals may be required prior to the sale or operation of the device, and agrees to utilize the component in keeping with all laws governing its use in the country of operation.

When working with RF, a clear distinction must be made between what is technically possible and what is legally acceptable in the country where operation is intended. Many manufacturers have avoided incorporating RF into their products as a result of uncertainty and even fear of the approval and certification process. Here at Linx, our desire is not only to expedite the design process, but also to assist you in achieving a clear idea of what is involved in obtaining the necessary approvals to legally market your completed product.

In the United States, the approval process is actually quite straightforward. The regulations governing RF devices and the enforcement of them are the responsibility of the Federal Communications Commission (FCC). The regulations are contained in Title 47 of the Code of Federal Regulations (CFR). Title 47 is made up of numerous volumes; however, all regulations applicable to this module are contained in Volume 0-19. It is strongly recommended that a copy be obtained from the Government Printing Office in Washington or from your local government bookstore. Excerpts of applicable sections are included with Linx evaluation kits or may be obtained from the Linx Technologies website, www.linxtechnologies.com. In brief, these rules require that any device that intentionally radiates RF energy be approved, that is, tested for compliance and issued a unique identification number. This is a relatively painless process. Linx offers full EMC pre-compliance testing in our HP / Emco-equipped test center. Final compliance testing is then performed by one of the many independent testing laboratories across the country. Many labs can also provide other certifications that the product may require at the same time, such as UL, CLASS A / B, etc. Once your completed product has passed, you will be issued an ID number that is to be clearly placed on each product manufactured.

Questions regarding interpretations of the Part 2 and Part 15 rules or measurement procedures used to test intentional radiators, such as Linx RF modules, for compliance with the technical standards of Part 15, should be addressed to:

Federal Communications Commission
 Equipment Authorization Division
 Customer Service Branch, MS 1300F2
 7435 Oakland Mills Road
 Columbia, MD 21046

Phone: (301) 725-1585 Fax: (301) 344-2050 E-Mail: labinfo@fcc.gov

International approvals are slightly more complex, although Linx modules are designed to allow all international standards to be met. If you are considering the export of your product abroad, you should contact Linx Technologies to determine the specific suitability of the module to your application.

All Linx modules are designed with the approval process in mind and thus much of the frustration that is typically experienced with a discrete design is eliminated. Approval is still dependent on many factors, such as the choice of antennas, correct use of the frequency selected, and physical packaging. While some extra cost and design effort are required to address these issues, the additional usefulness and profitability added to a product by RF makes the effort more than worthwhile.

ACHIEVING A SUCCESSFUL RF IMPLEMENTATION

Adding an RF stage brings an exciting new dimension to any product. It also means that additional effort and commitment will be needed to bring the product successfully to market. By utilizing premade RF modules, such as the LR Series, the design and approval process is greatly simplified. It is still important, however, to have an objective view of the steps necessary to ensure a successful RF integration. Since the capabilities of each customer vary widely, it is difficult to recommend one particular design path, but most projects follow steps similar to those shown at the right.

In reviewing this sample design path, you may notice that Linx offers a variety of services (such as antenna design and FCC prequalification) that are unusual for a high-volume component manufacturer. These services, along with an exceptional level of technical support, are offered because we recognize that RF is a complex science requiring the highest caliber of products and support. "Wireless Made Simple" is more than just a motto, it's our commitment. By choosing Linx as your RF partner and taking advantage of the resources we offer, you will not only survive implementing RF, you may even find the process enjoyable.

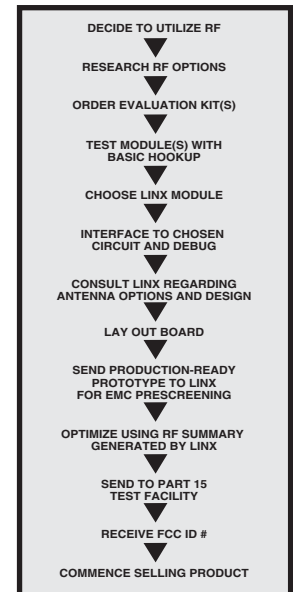

Typical Steps For Implementing RF

HELPFUL APPLICATION NOTES FROM LINX

It is not the intention of this manual to address in depth many of the issues that should be considered to ensure that the modules function correctly and deliver the maximum possible performance. As you proceed with your design, you may wish to obtain one or more of the following application notes, which address in depth key areas of RF design and application of Linx products. These applications notes are available online at www.linxtechnologies.com or by contacting the Linx literature department.

NOTE	APPLICATION NOTE TITLE
AN-00100	RF 101: Information for the RF Challenged
AN-00125	Considerations For Operation Within The 260-470MHz Band
AN-00130	Modulation Techniques For Low-Cost RF Data Links
AN-00140	The FCC Road: Part 15 From Concept To Approval
AN-00150	Use and Design of T-Attenuation Pads
AN-00160	Considerations For Sending Data Over a Wireless Link
AN-00232	General Considerations For Sending Data With The LC Series
AN-00500	Antennas: Design, Application, Performance



U.S. CORPORATE HEADQUARTERS

LINX TECHNOLOGIES, INC.

**159 ORT LANE
MERLIN, OR 97532**

PHONE: (541) 471-6256

FAX: (541) 471-6251

www.linxtechnologies.com

Disclaimer

Linx Technologies is continually striving to improve the quality and function of its products. For this reason, we reserve the right to make changes to our products without notice. The information contained in this Overview Guide is believed to be accurate as of the time of publication. Specifications are based on representative lot samples. Values may vary from lot-to-lot and are not guaranteed. "Typical" parameters can and do vary over lots and application. Linx Technologies makes no guarantee, warranty, or representation regarding the suitability of any product for use in any specific application. It is the customer's responsibility to verify the suitability of the part for the intended application. NO LINX PRODUCT IS INTENDED FOR USE IN ANY APPLICATION WHERE THE SAFETY OF LIFE OR PROPERTY IS AT RISK.

Linx Technologies DISCLAIMS ALL WARRANTIES OF MERCHANTABILITY AND FITNESS FOR A PARTICULAR PURPOSE. IN NO EVENT SHALL LINX TECHNOLOGIES BE LIABLE FOR ANY OF CUSTOMER'S INCIDENTAL OR CONSEQUENTIAL DAMAGES ARISING IN ANY WAY FROM ANY DEFECTIVE OR NON-CONFORMING PRODUCTS OR FOR ANY OTHER BREACH OF CONTRACT BY LINX TECHNOLOGIES. The limitations on Linx Technologies' liability are applicable to any and all claims or theories of recovery asserted by Customer, including, without limitation, breach of contract, breach of warranty, strict liability, or negligence. Customer assumes all liability (including, without limitation, liability for injury to person or property, economic loss, or business interruption) for all claims, including claims from third parties, arising from the use of the Products. The Customer will indemnify, defend, protect, and hold harmless Linx Technologies and its officers, employees, subsidiaries, affiliates, distributors, and representatives from and against all claims, damages, actions, suits, proceedings, demands, assessments, adjustments, costs, and expenses incurred by Linx Technologies as a result of or arising from any Products sold by Linx Technologies to Customer. Under no conditions will Linx Technologies be responsible for losses arising from the use or failure of the device in any application, other than the repair, replacement, or refund limited to the original product purchase price. Devices described in this publication may contain proprietary, patented, or copyrighted techniques, components, or materials. Under no circumstances shall any user be conveyed any license or right to the use or ownership of such items.