

Ultra Small SMT Coaxial Connectors - Low Profile 1.9mm or 2.4mm Mated Height

U.FL Series

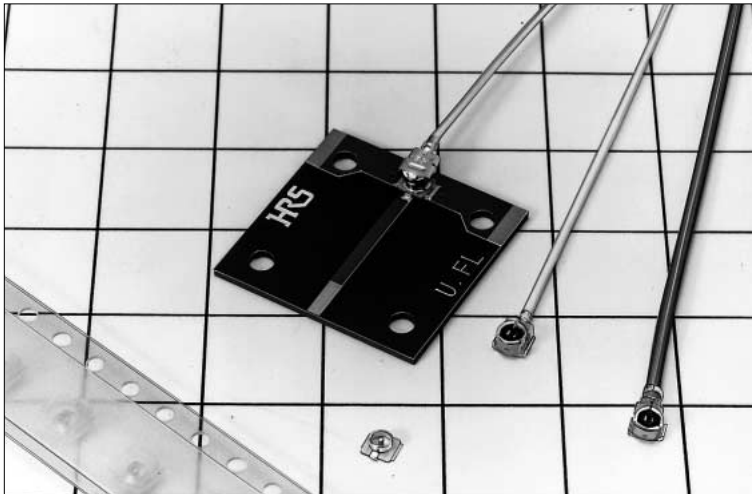

Meets up to 6 GHz Requirement

Mated Height Comparison
(With Hirose Product)

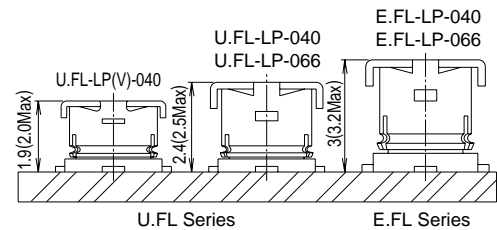

■ Features

1. Low Profile: 1.9mm or 2.4mm Nom. Mated Height

Height from the circuit board is 2.0mm or 2.5mm maximum when a plug (right angle) is mated to a receptacle, which ranks with world's smallest class.

2. Extremely Small Occupied Mounting Area

In comparison with our SMT coaxial connectors E.FL series, the receptacle provides a reduction of approximately 18% of occupied mounting surface, which is only 7.7mm².

3. Light Weight

One of the world's lightest coaxial connectors.
Receptacle: 15.7mg

4. Applicable Up to 6 GHz Frequency

To meet the frequency requirements of a wide variety of miniature equipment, these connectors offer high frequency performance from DC to 6 GHz.

5. Board placement with automatic equipment

Supplied on tape-and-reel packaging.

6. Use of Ultra-fine Teflon Cable

From among the types of applicable cable, dia. 0.81mm (single shielded) ultra-fine Teflon coaxial cable has been made a standard specification in construction area.

Refer to the following pages for different cable types.

7. Simple Removal of Connector

The extraction jig permits simple removal of connectors.

8. User Friendly Mating Operation

Tactile lock feeling ensures engagement even with this small size.

■ Applications

Mobile phones, Wireless LAN, Mini-PCI, Bluetooth, PDA, GPS, electronic measuring instruments, etc.

● Space Factor of Mated Connector

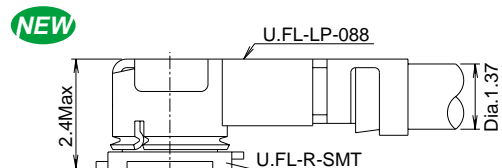
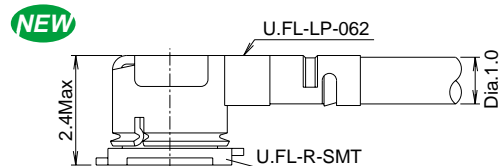
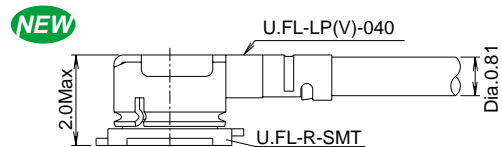
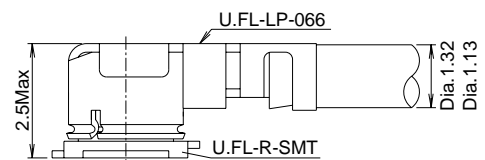
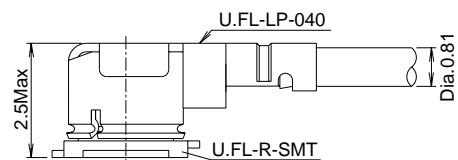

Product Specifications

Ratings	Nominal characteristic impedance Voltage rating Frequency range	50 ohms 60 V AC (rms) DC to 6 GHz	Operating temperature range Operating humidity	-40°C to +90°C 90% max.
---------	---	---	---	----------------------------

Item	Specification	Conditions	
1. Contact resistance	Center: 20 m ohms max. Outside: 10 m ohms max.	10 mA max.	
2. Insulation resistance	500 M ohms min.	100 V DC	
3. Withstanding voltage	No flashover or insulation breakdown.	200 V AC / 1 minute	
4. V.S.W.R.*	Part No.	Up to 3GHz	3 to 6GHz
	U.FL-LP-040 dia.0.81mm Coaxial Cable Assembly	1.3 Max	1.35 Max
	U.FL-LP(V)-040 dia.0.81mm Coaxial Cable Assembly	1.3 Max	1.3 Max
	U.FL-LP-066 dia.1.13mm Coaxial Cable Assembly	1.3 Max	1.4 Max
	U.FL-LP-066 dia.1.32mm Coaxial Cable Assembly	1.3 Max	1.5 Max
	U.FL-LP-062 dia.1mm Coaxial Cable Assembly	1.3 Max	1.3 Max
	U.FL-LP-088 dia.1.37mm Coaxial Cable Assembly	1.3 Max	1.4 Max
5. Female contact holding force	0.15 N min.	Measured with a ϕ 0.475 pin gauge	
6. Durability (mating/un-mating, with corresponding plug)	Contact resistance Center: 25 m ohms max. Outside: 15 m ohms max.	30 cycles	
7. Vibration	No electrical discontinuity of 1 μ s min.	Frequency: 10 to 100 Hz, single amplitude of 1.5mm, acceleration of 59m/s ² , for 5 cycles in the direction of each of the 3 axis.	
8. Shock	No damage, cracks or parts dislocation.	Acceleration of 735 m/s ² , 11ms duration, sine half-wave waveform, 2 cycles in each of 3 axes.	
9. Humidity (Steady state)	No damage, cracks or parts dislocation. Insulation resistance 100 M ohms min.(when humidity high) Insulation resistance 500 M ohms min.(when dry)	96 hours at temperature of 40°C and humidity of 95%.	
10. Temperature cycle	No damage, cracks or parts dislocation. Contact resistance:25 m ohms max. (Center) 15 m ohms max. (Outside)	Temperature:-40°C→+5 to +35°C→+90°C→+5 to +35°C Time: 30 → 5 max. →30 →5 max.(Minutes) 5 cycles	
11. Salt spray test	No excessive corrosion	5% salt water solution, 48 hours	

*V.S.W.R. Measurement System

The above V.S.W.R. standard values were measured using the measurement system of the diagram below.

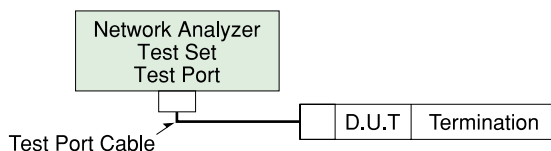

Note 1: Cable type connectors were measured with SMA conversion adapters attached to both ends of the harness product of a suitable 100cm cable.

Note 2: Board type connectors were mounted to a 50 Ω glass epoxy board and measurements were conducted with SMA conversion adapters attached.

Materials

Part	Material		Finish	Remarks
Shell	Phosphor bronze		Silver plating	_____
Male center contact	Brass		Gold plating	_____
Female center contact	Phosphor bronze		Gold plating	_____
Insulator	Plug	PBT	Color: Black	UL94V-0
	Receptacle	LCP	Color: Beige	UL94V-0

■ Cable Assembly (Plug)

Part No.	U.FL-LP-040	U.FL-LP-066	U.FL-LP(V)-040	U.FL-LP-062	U.FL-LP-088
Mated Height	2.5mm Max. (2.4mm Nom.)	2.5mm Max. (2.4mm Nom.)	2.0mm Max. (1.9mm Nom.)	2.4mm Max. (2.3mm Nom.)	2.4mm Max. (2.3mm Nom.)
Applicable cable	Dia. 0.81mm Coaxial cable	Dia. 1.13mm and Dia. 1.32mm Coaxial cable	Dia. 0.81mm Coaxial cable	Dia. 1mm Coaxial cable	Dia. 1.37mm Coaxial cable
Weight (mg)	53.7	59.1	34.8	45.5	71.7

● Cable Guide

Description	Cable Type	Cable Specification						
		Inner Conductor*	Dielectric Diameter	Outer Conductor*	Jacket Diameter	Nominal Impedance	Nominal attenuation	
						At 3GHz	At 6GHz	
Dia.0.81mm Coaxial Cable	04	7/0.05 SA (AWG36)	Dia.0.40 PFA	Single Shield SA	Dia.0.81 PFA	50 ohms	6.45dB/m	9.42dB/m
Dia.1.13mm Coaxial Cable	068	7/0.08 SA (AWG32)	Dia.0.68 FEP	Single Shield SA[TA]	Dia.1.13 FEP	50 ohms	3.43dB/m [3.73dB/m]	5.13dB/m [5.44dB/m]
Dia.1.32mm Coaxial Cable	066	7/0.08 SA (AWG32)	Dia.0.66 FEP	Double Shield TA	Dia.1.32 FEP	50 ohms	3.8dB/m	5.6dB/m
Dia.1mm Coaxial Cable	062	7/0.071 SA (AWG33)	Dia.0.62 FEP	Tape, single Shield TAT	Dia.1 FEP	50 ohms	3.1dB/m	4.4dB/m
Dia.1.37mm Coaxial Cable	088	7/0.102 SA (AWG30)	Dia.0.88 FEP	Single Shield TA	Dia.1.37 FEP	50 ohms	2.8dB/m	4.3dB/m

(data as provided by material suppliers, for reference only)

* SA : Silver plated annealed copper wire, TA : Tin plated annealed copper wire, TAT : Tin plated copper wire alloyed with tin

■ How to Specify Cable Assembled Plug

Dimension of U.FL Series assembly products should be made as indicated below.

Double-Ended Cable Assembly	Single-Ended Cable Assembly

● Ordering Information

U.FL - [1] LP - [2] - A - (L)

① ② ③ ④

① Series name	U.FL
② Assembly type	LP: Single ended 2LP: Double ended
③ Cable type	04 : Dia.0.81mm Coaxial Cable 068 : Dia.1.13mm Coaxial Cable 066 : Dia.1.32mm Coaxial Cable 062 : Dia.1 mm Coaxial Cable 088 : Dia.1.37mm Coaxial Cable
④ Total Length(mm)	Length is expressed in mm units.

● Total Standard Tolerance for Total Length of Cable Assembly

Total Length(mm)	Standard Tolerance (mm)
35 ≤ L ≤ 200	± 4
200 < L ≤ 500	± 8
500 < L ≤ 1000	±12
1000 < L	±1.5%

Note: Shortest length L is 35 mm.

Please contact Hirose Sales Representative for cable length and cable end treatment.

■ Receptacles

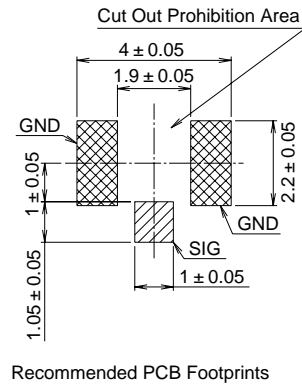
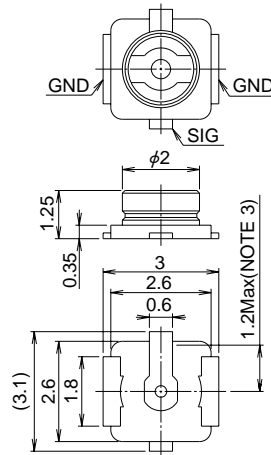
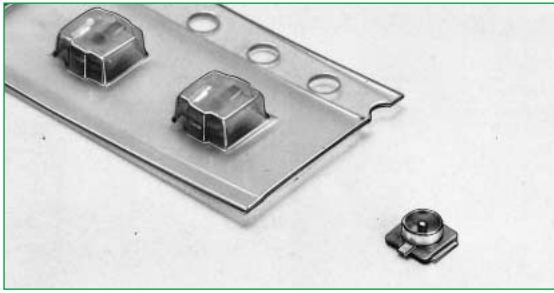

Note 1: Receptacles of (01) specification are sold by the pack with 100 pieces per pack. Please order in pack units.

Note 2: Receptacles of (10) specification are sold by the reel (which contains 2,500 pieces). Please order in reel units.

Note 3: Permissible value for mold resin which gets onto the center contact.

Part No.	CL No.	Packaging	Weight (mg)
U.FL-R-SMT(01)	331-0471-0-01	Bag packaging (100 pieces/bag)	15.7/unit
U.FL-R-SMT(10)	331-0471-0-10	Reel packaging (2500 pieces/reel)	

● Packaging Specifications

Embossed Carrier Tape Dimensions

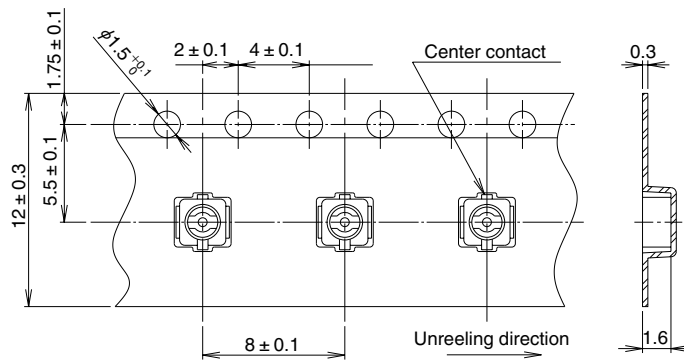

Reel Dimensions

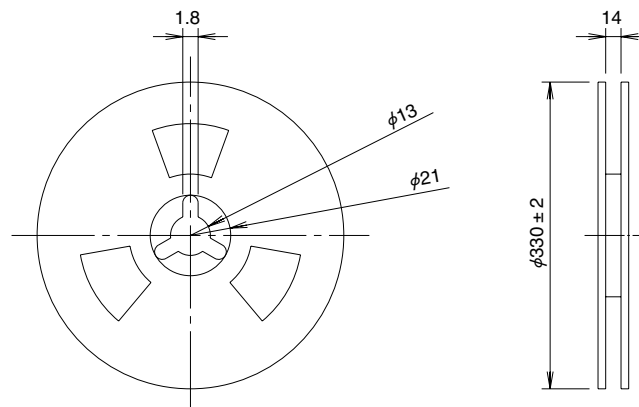

■ Conversion Adapter

● SMA Conversion Adapter

(Mating portion: U.FL side jack - SMA side plug)



Note: The U.FL side mating portions has a lower lock retention force than the regular product, therefore, cannot be used for purposes other than performance measurements.

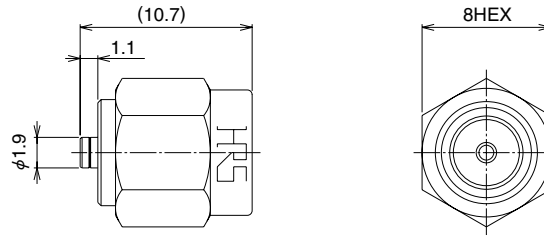

Part No.	CL No.
HRMP-U.FLJ	311-0300-2

● SMA Conversion Adapter

(Mating portion: U.FL side plug - SMA side jack)



Note: The U.FL side mating portions has a lower lock retention force than the regular product, therefore, cannot be used for purposes other than performance measurements.

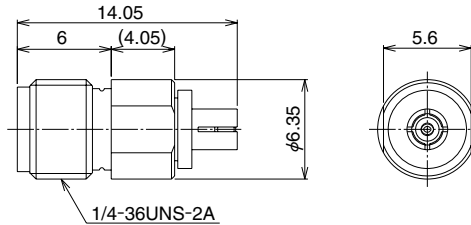

Part No.	CL No.
HRMJ-U.FLP	311-0301-5

● SMA Conversion Adapter

(Mating portion: U.FL side plug-SMA side jack)



Note: This connector is used by compressing the mated portion of U.FL side onto the U.FL-R-SMT portion.

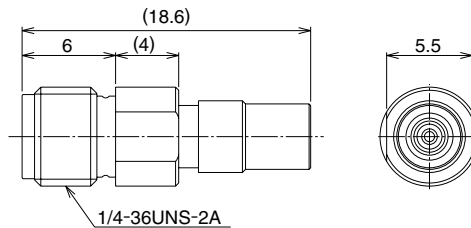

Part No.	CL No.
HRMJ-U.FLP-ST1	311-0385-5

■ Receptacle for Check

This receptacle is used for inspecting the continuity, withstand voltage, and other aspects of the harness product.



This receptacle is used for check the continuity, withstanding voltage, and other performance of the cable assembly products.

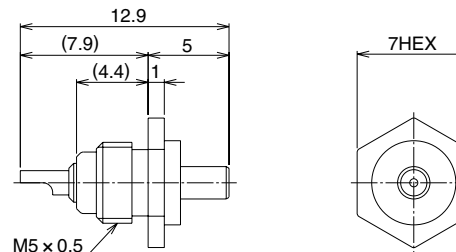

Part No.	CL No.
U.FL-R-1	331-0466-0

■ Extraction Jig

This jig is used for extraction from a mating condition.



Note: Part No. U.FL-LP-N-2 for U.FL-LP-040/066/088.
Part No. U.FL-LP(V)-N-2 for U.FL-LP(V)-040/U.FL-LP-062.

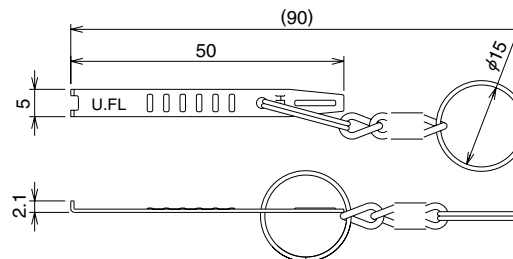

Part No.	CL No.
U.FL-LP-N-2	331-0494-5
U.FL-LP(V)-N-2	331-0493-2

Usage Precautions

1. Plugs

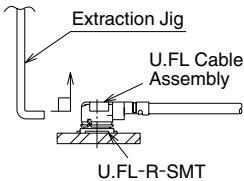
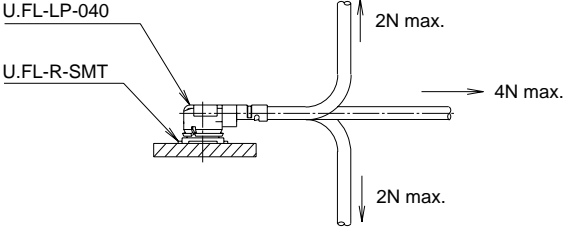
<p>(1) Connection/ disconnection of connectors</p>	<p>1) To disconnect connectors, hook the end portion of U.FL-LP-N-2 and U.FL-LP(V)-N-2 onto the connector cover and pull off vertically in the direction of the connector mating axis. To remove the connector directly, hold the connector cover and pull off vertically in the direction of the connector mating axis. (Please exercise caution so as not to injure fingertips or nails.)</p> <p>2) To mate the connectors, the mating axes of both connectors are aligned and the connectors are inserted as perpendicularly as possible. Do not attempt to insert on an extreme angle.</p>	
<p>(2) Permissible load on the cable after connector mating.</p>	<p>After the connectors are mating, do not apply a load to the cable in excess of the values indicated in the diagram below.</p> 	
<p>(3) Precautions</p>	<p>Do NOT forcefully twist or deform wires.</p>	

2. Receptacles

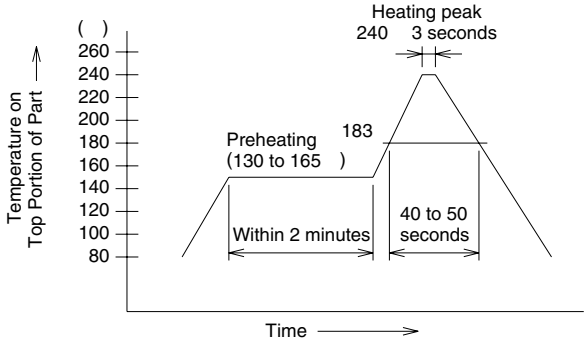
<p>(1) Recommended temperature profile (Reference)</p>	 <p>1) The temperature profile indicates the board surface temperature at the point of contacts with the connector terminals (for surface mounted receptacle). 2) The temperature profile will change depending on conditions which include such factors as the size of the board, the solder used, and the solder thickness.</p>	
<p>(2) Recommended manual soldering (Reference)</p>	<p>Manual soldering: 350°C for 5 seconds</p>	
<p>(3) Recommended screen thickness</p>	<p>0.1 to 0.15 mm</p>	

NOTES :

A series of horizontal dashed lines for writing notes.

USA:**HIROSE ELECTRIC U.S.A., INC.**

2688 Westhills Court, Simi Valley, CA 93065-6235

Phone : 1 805 522 7958

Fax : 1 805 522 3217

<http://www.hirose.com>**UNITED KINGDOM:****HIROSE ELECTRIC UK LTD.**Crownhill Business Centre 22 Vincent Avenue
Crownhill, Milton Keynes MK8 OAB

Phone : 44 1908 305400

Fax : 44 1908 305401

<http://www.hirose.co.uk>**HONG KONG:****HIROSE ELECTRIC CO., LTD.**Unit 506, Energy Plaza. 92 Granville Road, Tsim Sha
Tsui East, Kowloon

Phone : 852 2803 5338

Fax : 852 2591 6560

EUROPE BRANCH:**HIROSE ELECTRIC CO., LTD.**

Beechavenue 46.1119PV

Schiphol-Rijk, The Netherlands

Phone : 31 20 6557460

Fax : 31 20 6557469

<http://hiroseeurope.com>**KOREA:****HIROSE KOREA CO., LTD.**

(#2NA311, Shihwa Industrial Complex),

1261-10, Jeongwhang-Dong, Shihung-City, Kyunggi-Do

Phone : 82 31 496 7000, 7124

Fax : 82 31 496 7100

<http://www.hirose.co.kr>**TAIWAN:****HIROSE ELECTRIC CO., LTD.**

No.28 Lane 247 Sec. 2 Yen Ping N, Rd. Taipei

Phone : 886 2 2557 7351, 7352

Fax : 886 2 2552 9851

GERMANY:**HIROSE ELECTRIC GmbH**

Zeppelinstrasse 42 D-73760 Ostfildern Kemnat

Phone : 49 711 4560021

Fax : 49 711 4560729

<http://www.hirose.de>**CHINA:****HIROSE ELECTRIC TRADING(SHANGHAI) CO., LTD.**

3705, Bund Center, 222 Yan An Road(E), Shanghai 20002

Phone : 86 21 6335 2538

Fax : 86 21 6335 0767

SINGAPORE:**HIROSE ELECTRIC CO., LTD.**

10 Anson Road #34-13 International Plaza 079903

Phone : 65 6324 6113

Fax : 65 6324 6123

**HRS****HIROSE ELECTRIC CO., LTD.**5-23, OSAKI 5-CHOME, SHINAGAWA-KU, TOKYO 141-8587, JAPAN
PHONE: 81-3-3491-9741, FAX: 81-3-3493-2933