

# UGP20A thru UGP20K

## Glass Passivated Junction Ultra Fast Rectifiers Reverse Voltage 50 to 800V Forward Current 2.0A

### FEATURES

- \* Plastic package has Underwriters Laboratories Flammability Classification 94V-0
- \* Ideally suited for use in very high frequency switching power supplies, inverters and as free wheeling diodes
- \* Ultrafast recovery time for high efficiency
- \* Excellent high temperature switching
- \* Soft recovery characteristics
- \* Cavity-free glass passivated junction
- \* High temperature soldering guaranteed:  
260°C/10 seconds, 0.375" (9.5mm) lead length, 5 lbs. (2.3kg) tension

### Mechanical Data

**Case:** JEDEC DO-15, molded plastic over glass DIE

**Terminals:** Plated axial leads, solderable per MIL-STD-750, Method 2026

**Polarity:** Color band denotes cathode end

**Mounting Position:** Any

**Weight:** 0.015oz., 0.40 g

**Handling precaution:** None

### 1. Electrical Characteristic

**Maximum Ratings & Thermal Characteristics Ratings at 25°C ambient temperature unless otherwise specified.**

Parameter Symbol	symbol	UGP20 A	UGP20 B	UGP20 D	UGP20 F	UGP20 G	UGP20 J	UGP20 K	Unit	
device marking code		UGP20 A	UGP20 B	UGP20 D	UGP20 F	UGP20 G	UGP20 J	UGP20 K		
Maximum repetitive peak reverse voltage	$V_{RRM}$	50	100	200	300	400	600	800	V	
Maximum RMS voltage	$V_{RMS}$	35	70	140	210	280	420	560	V	
Maximum DC blocking voltage	$V_{DC}$	50	100	200	300	400	600	800	V	
Maximum average forward rectified current 0.375" (9.5mm) lead length at $T_A = 55^\circ\text{C}$	$I_F(AV)$	2.0								A
Peak forward surge current 8.3ms single half sine-wave superimposed on rated load (JEDEC Method)	$I_{FSM}$	65					60			A
Maximum full load reverse current, full cycle average, 0.375" (9.5mm) lead lengths at $T_A = 55^\circ\text{C}$	$I_R(AV)$	100								$\mu\text{A}$
Typical thermal resistance (Note 2)	$R_{\theta JA}$	40								$^\circ\text{C}/\text{W}$
Operating junction and storage temperature range	$T_J, T_{STG}$	-50 to +150								$^\circ\text{C}$

**Electrical Characteristics Ratings at 25°C ambient temperature unless otherwise specified.**

Parameter Symbol	symbol	UGP20 A	UGP20 B	UGP20 D	UGP20 F	UGP20 G	UGP20 J	UGP20 K	Unit	
Maximum instantaneous forward voltage at 2.0A	$V_F$	0.95			1.25		1.70	2.20	V	
Maximum DC reverse current $T_A = 25^\circ\text{C}$ at rated DC blocking voltage $T_A = 125^\circ\text{C}$	$I_R$	10				100				$\mu\text{A}$
Typical reverse recovery time (Note 1)	$t_{rr}$	35								ns
Typical junction capacitance at 4.0V, 1MHz	$C_J$	22								PF

NOTES:

1.  $I_F = 0.5\text{A}$ ,  $I_R = 1.0\text{A}$ ,  $IRR = 0.25\text{A}$

2. Thermal resistance from junction to ambient at 0.375" (9.5mm) lead length, P.C.B. mounted

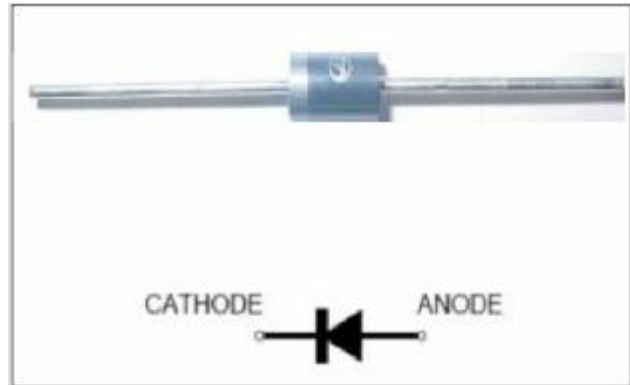

We declare that the material of product compliance with ROHS requirements

# UGP20A thru UGP20K

## 2. Ratings and Characteristic Curves ( TA = 25°C unless otherwise noted )

Fig. 1 - Forward Current Derating Curve

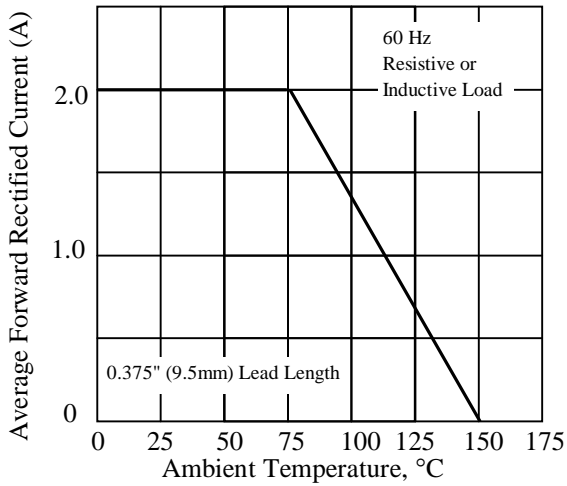

Fig. 2 - Maximum Non-repetitive Peak Forward Surge Current

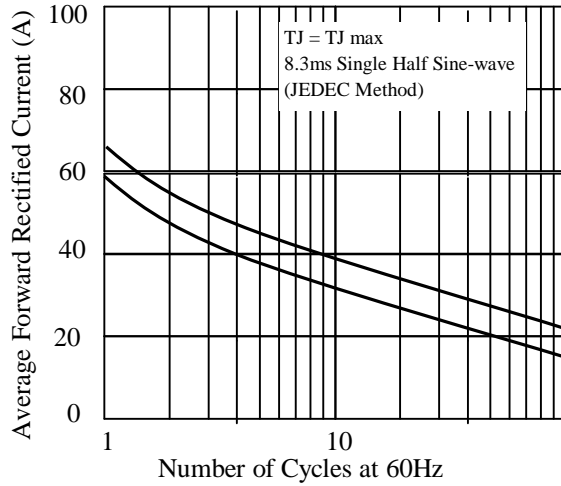

Fig 3. - Typical Instantaneous Forward Characteristics

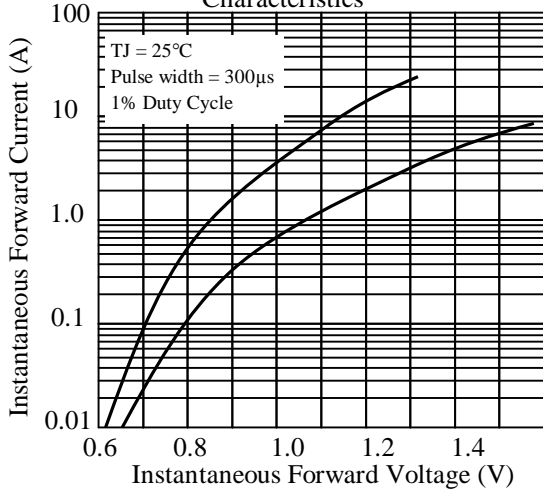

Fig 4. - Typical Reverse Characteristics

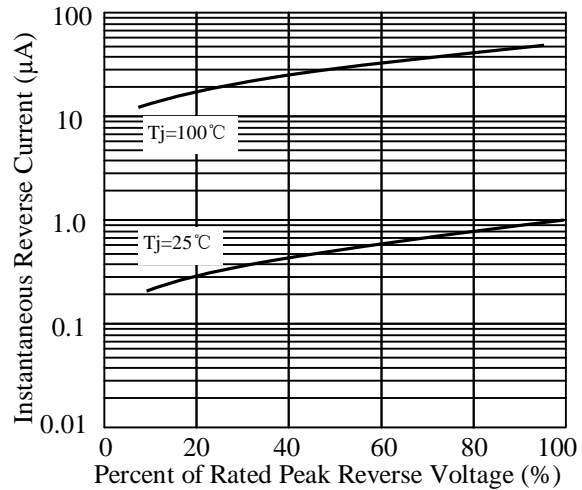

Fig 5. - typical transient thermal impedance

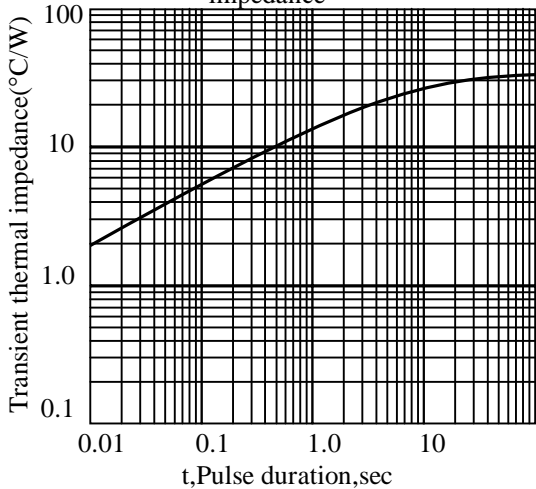
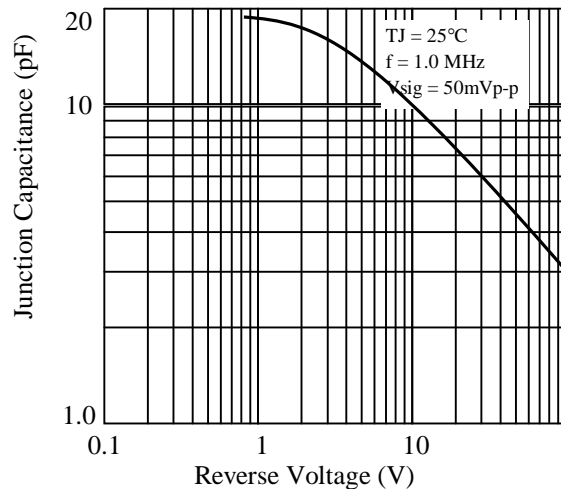
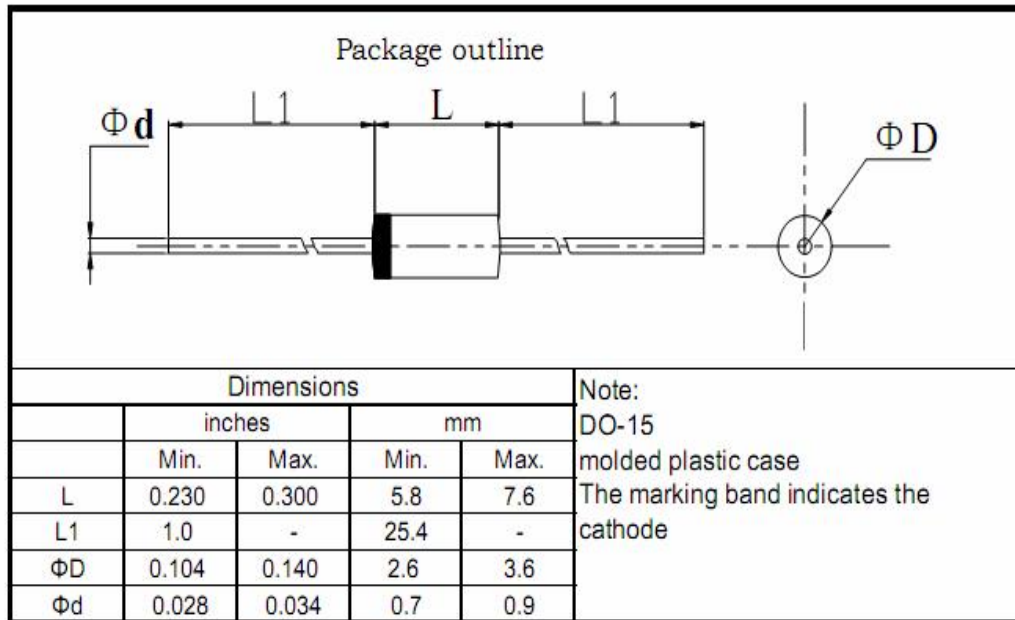

Fig 6. - Typical Junction Capacitance



## UGP20A thru UGP20K

### 3. dimension:



标题：  <b>塑封生产线轴向产品包装规范</b>	文件编号： WI-250
	第 4 版 第 0 次修改
	第 1 页

- 1 弹带盒装 ammo and box
- 1.1. 弹带盒规格 ammo spec.

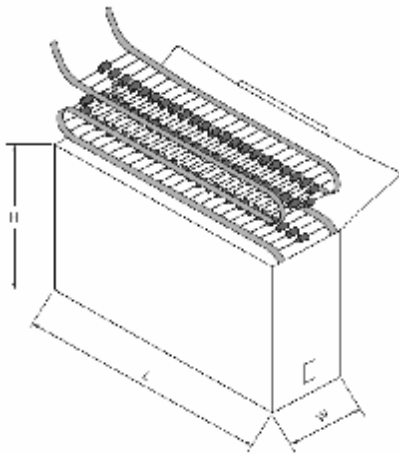

单位：mm

	L	W	H
T52	262±2	76±2	90±2
T42	262±2	64±2	90±2
T26	250±3	45±3	95±3

- 1.2 弹带内盒要求 inner box spec.

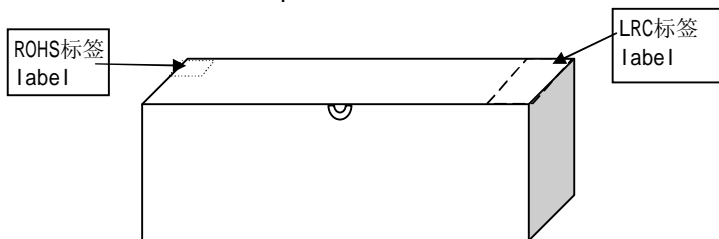

标题: <b>塑封生产线轴向产品包装规范</b>	文件编号: WI-250
	第 4 版 第 0 次修改
	第 2 页

1.4 标签要求 label spec.

1.4.1 LRC标签 LRC label

成型 FORMING \*\*\*\*\* ← 成型规格 forming spec.

型号 TYPE \*\*\*\*\* ← LRC产品型号 type

重复峰压 (V) PRV (V)	****	← 产品重复峰压值 peak repetitive voltage
额定电流 (A) I <sub>o</sub> (A)	**	← 产品额定电流值 average output current
数量 (只) QTY (pcs)	****	← 产品数量 quantity
检验员 CHECKER	02	
日期: DATE:	*****	← 产品生产日期 date

1.4.2 环保标签 environmental protection label



2. 外箱规格 carton spec.

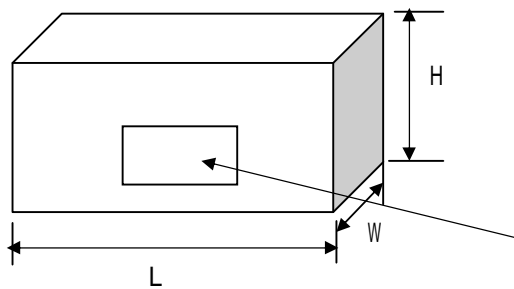

单位: mm

	L	W	H
T52	430±2	280±2	225±2
T42	410±2	285±2	300±2
T26	435±3	280±3	295±3

外箱标签 carton label

3 按以上包装方式, 编带数量和外包装箱产品数量: typing and carton spec.

	塑封外型			
	A-405 & DO-41 & R-1	R-3	DO-15	DO-201AD
每根编带数量 quantity/ammo	3K	1.8K	2K(T52) 1.8K(T26)	0.8K
外箱数量 (T52编带) quantity/cartoon	30K	18K	20K	8.0K
外箱数量 (T26编带) quantity/cartoon	60K	36K	36K	-
外箱数量 (T42编带) quantity/cartoon	54K	32.4K	36K	-

标题:

塑封生产线轴向产品包装规范

文件编号: WI-250

第 4 版 第 0 次修改

第 3 页

4 编带规格 brede spec



尺寸代号	编带尺寸 typing dimension					
	26/tape	35/tape	40/tape	42/tape	52/tape	52/tape#
<b>W</b>	26 0.0/+1.6	35 -1.0/+0.5	40 -1.0/+0.5	42 -1.0/+1.0	52 -1.0/+2.0	52 -1.0/+2.0
<b>P</b>	5±0.5	5±0.5	5±0.5	5±0.5	5±0.5	10±0.5
<b>L1-L2</b>	<1.0	<1.0	<1.0	<1.0	<1.0	<1.0
<b>H</b>	6±1.0	6±1.0	6±1.0	6±1.0	6±1.0	6±1.0
<b>Z</b>	<1.0	<1.0	<1.0	<1.0	<1.0	<1.0
<b>R</b>	<1.0	<1.0	<1.0	<1.0	<1.0	<1.0
<b>T</b>	>3.5	>3.5	>3.5	>3.5	>3.5	>3.5

注: 52编带# 为DO-201AD编带规格 "52编带#" just for D0-201AD

1. 红白编带厚度为0.05mm; 两种胶带各自之间无明显色差; 编带要求均为胶带。  
The typing thickness is 0.05mm and color is obvious difference
2. 两端引带20~40cm. Typing lead over 20~40cm
3. 红色编带一端为二极管“负极”; 白色编带一端为二极管“正极”。  
red color is cathode ,white color is anode
4. 无卤 green epoxy compound (无卤产品才贴HF only)

Green



**LRC**

乐山无线电股份有限公司  
Leshan Radio Company, Ltd

## UGP20A thru UGP20K

### 4. Update Record

版次	更新记录	更新作者	更新日期
1	第一版	余波	2010-7-28
2	1.增加包装规范。	周杰	2011-10-28