

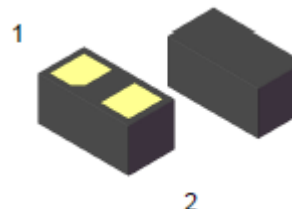

## Features

- Ultra low leakage: nA level
- Operating voltage: 5V
- Low clamping voltage
- Complies with following standards:
  - IEC 61000-4-2 (ESD) immunity test
    - Air discharge:  $\pm 30\text{kV}$
    - Contact discharge:  $\pm 25\text{kV}$
  - IEC61000-4-4 (EFT) 40A (5/50ns)
  - IEC61000-4-5 (Lightning) 4A (8/20 $\mu\text{s}$ )
- RoHS Compliant

## Dimensions DFN0603



## Pin Configuration

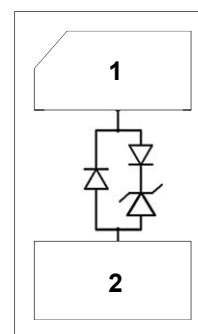

## Applications

- USB 2.0 power and data line
- Set-top box and digital TV
- Digital video interface (DVI)
- Notebook Computers
- SIM Ports
- 10/100 Ethernet

## Mechanical Characteristics

- Package: DFN0603
- Lead Finish: Lead Free
- UL Flammability Classification Rating 94V-0
- Quantity Per Reel: 10,000pcs
- Reel Size: 7 inch

## Absolute Maximum Ratings (T<sub>amb</sub>=25°C unless otherwise specified)

Parameter	Symbol	Value	Unit
Peak Pulse Power (8/20 $\mu\text{s}$ )	P <sub>pp</sub>	60	W
ESD per IEC 61000-4-2 (Air)	V <sub>ESD</sub>	$\pm 30$	Kv
ESD per IEC 61000-4-2 (Contact)		$\pm 25$	
Operating Temperature Range	T <sub>J</sub>	-55 to +125	°C
Storage Temperature Range	T <sub>STJ</sub>	-55 to +150	°C

## Electrical Characteristics (TA=25°C unless otherwise specified)

Part Number	Device Marking	V <sub>RWM</sub> (V)	V <sub>BR</sub> (V)	I <sub>T</sub> (mA)	V <sub>C</sub> @1A	V <sub>C</sub>		I <sub>R</sub> μA (Max)	C (Pf) (Typ.)
						(Max)	(@A)		
ULC0521	5Z	5	6.1	1	9	15	4	1	0.5

## Characteristic Curves

Fig1. 8/20μs Pulse Waveform

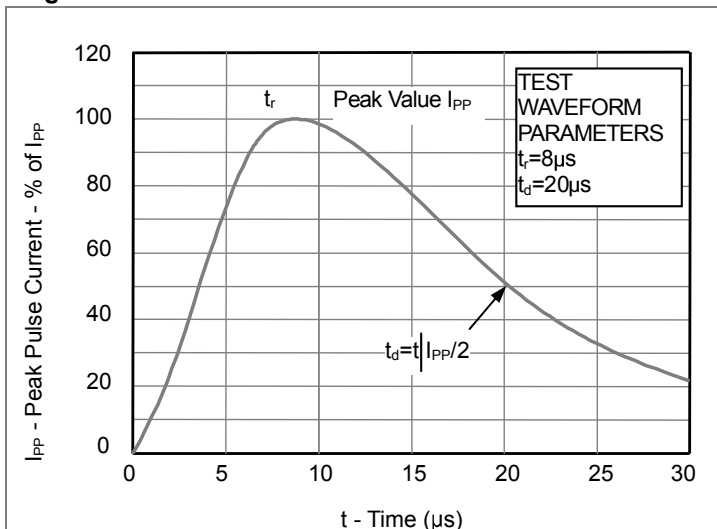

Fig2. ESD Pulse Waveform (according to IEC 61000-4-2)

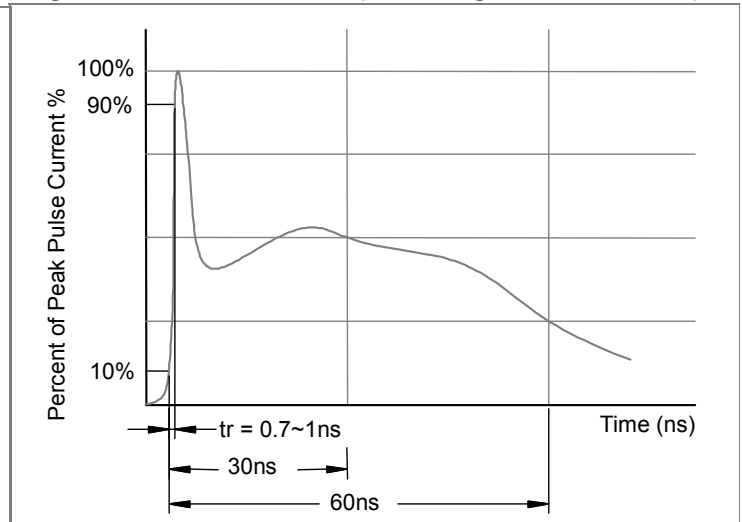
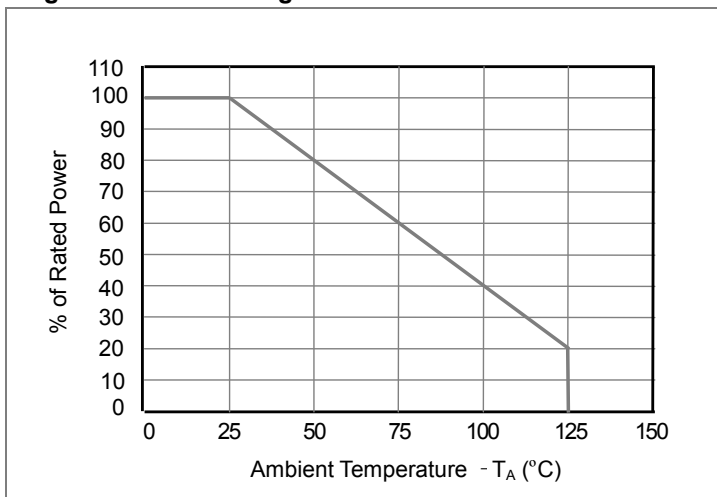
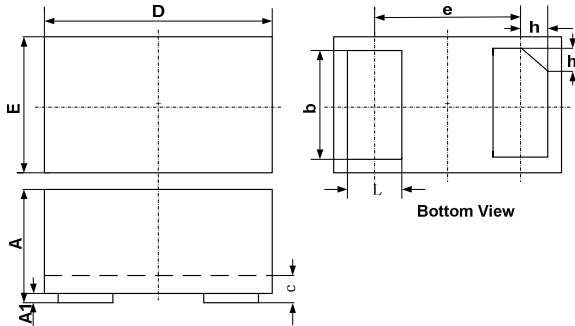

Fig3. Power Derating Curve



**DFN0603-2 Package Outline Drawing**



SYM	DIMENSIONS		
	MILLIMETERS		
	MIN	NOM	MAX
A	0.230		0.330
A1	0.000	0.020	0.050
b	0.215	0.245	0.275
c	0.120	0.150	0.180
D	0.550	0.600	0.650
e	0.355 BSC		
E	0.250	0.300	0.350
L	0.160	0.190	0.220
h	0.079 BSC		

**Suggested Land Pattern**

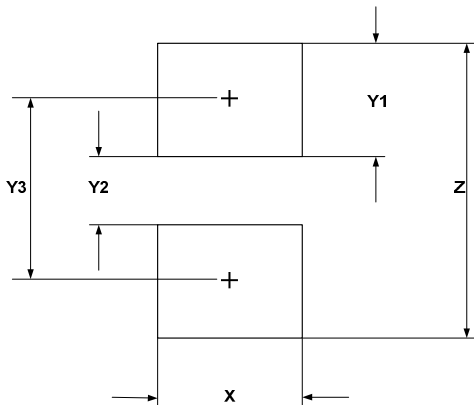

SYM	DIMENSIONS	
	MILLIMETERS	INCHES
X	0.30	0.012
Y1	0.25	0.010
Y2	0.15	0.006
Y3	0.40	0.016
Z	0.65	0.026