

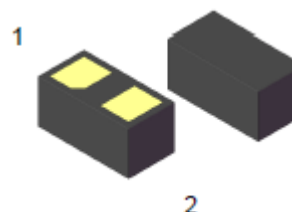

Features

- Ultra low leakage: nA level
- Operating voltage: 5V
- Low clamping voltage
- Complies with following standards:
 - IEC 61000-4-2 (ESD) immunity test
 - Air discharge: $\pm 25\text{kV}$
 - Contact discharge: $\pm 17\text{kV}$
 - IEC61000-4-4 (EFT) 40A (5/50ns)
 - IEC61000-4-5 (Lightning) 4A (8/20 μs)
- RoHS Compliant

Dimensions DFN0603



Pin Configuration

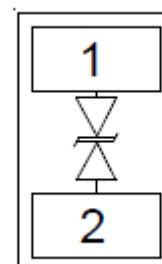

Applications

- USB 2.0 power and data line
- Set-top box and digital TV
- Digital video interface (DVI)
- Notebook Computers
- SIM Ports
- 10/100 Ethernet

Mechanical Characteristics

- Package: DFN0603
- Lead Finish: Lead Free
- UL Flammability Classification Rating 94V-0
- Quantity Per Reel: 15,000pcs
- Reel Size: 7 inch

Absolute Maximum Ratings (T_{amb}=25°C unless otherwise specified)

Parameter	Symbol	Value	Unit
Peak Pulse Power (8/20 μs)	P _{pp}	40	W
ESD per IEC 61000-4-2 (Air)	V _{ESD}	± 25	Kv
ESD per IEC 61000-4-2 (Contact)		± 17	
Operating Temperature Range	T _J	-55 to +125	°C
Storage Temperature Range	T _{STJ}	-55 to +150	°C

Electrical Characteristics (TA=25°C unless otherwise specified)

Part Number	Device Marking	V _{RWM} (V)	V _{BR} (V)	I _T (mA)	V _C @1A	V _C		I _R μA (Max)	C (Pf) (Typ.)
						(Max)	(@A)		
ULC0521C	-	5	6.1	1	11	25	4	1	0.5

Characteristic Curves

Fig1. 8/20μs Pulse Waveform

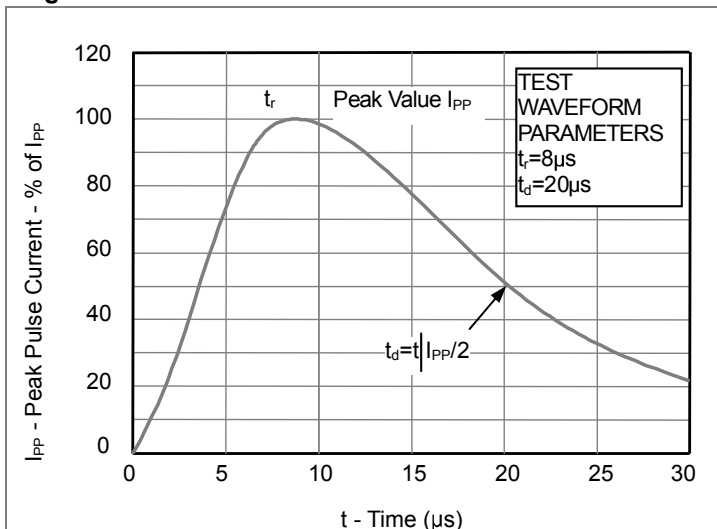

Fig2. ESD Pulse Waveform (according to IEC 61000-4-2)

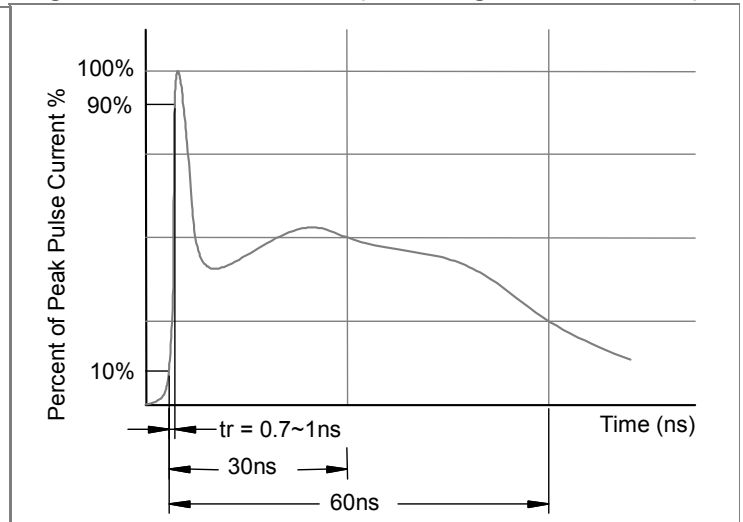
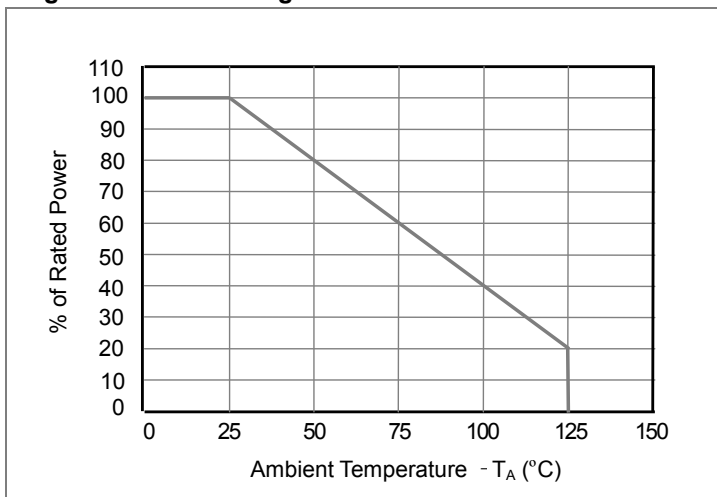
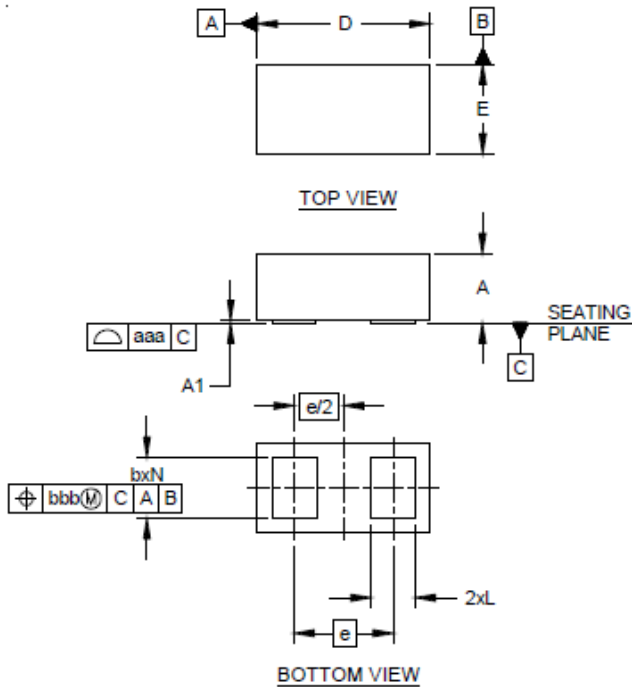

Fig3. Power Derating Curve



DFN0603 Package Outline Drawing



DIMENSIONS			
DIM	MILLIMETERS		
	MIN	NOM	MAX
A	0.235	0.25	0.265
A1	0.000	0.02	0.025
b	0.20	0.22	0.24
D	0.585	0.62	0.655
E	0.285	0.32	0.355
e	0.355BSC		
L	0.14	0.16	0.18
N	2		
aaa	0.08		
bbb	0.10		

Suggested Land Pattern

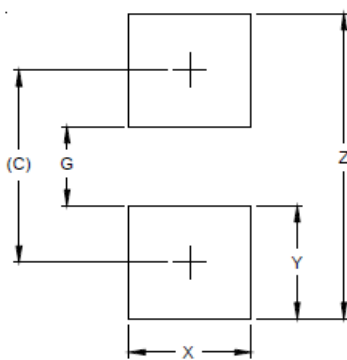

DIMENSIONS	
DIM	MILLIMETERS
C	0.425
G	0.175
X	0.270
Y	0.250
Z	0.675