

Transient Voltage Suppressors Array for ESD Protection

Low Capacitance

ULC3304P10

Description

The ULC3304P10 is designed to protect voltage sensitive components from ESD and transient voltage events. Excellent clamping capability, low leakage, and fast response time, make these parts ideal for ESD protection on designs where board space is at a premium.

Feature

- u 150 Watts Peak Pulse Power per Line ($t_p=8/20\mu s$)
- u Protects Four High Speed Lines
- u Low Clamping Voltage
- u RoHS Compliant
- u IEC61000-4-2 (ESD) $\pm 30kV$ (air), $\pm 30kV$ (contact)
- u IEC61000-4-4 (EFT) 40A (5/50ns)
- u IEC61000-4-5 (Lightning) 10A (8/20 μs)

Applications

- u Portable Electronics
- u USB OTG interfaces
- u Video Graphics Cards
- u Notebooks, Desktops, and Servers
- u Portable Instrumentation
- u Industrial Controls
- u Peripherals

Mechanical Characteristics

Symbol	Parameter	Value	Units
P_{PP}	Peak Pulse Power ($t_p=8/20\mu s$ waveform)	150	W
T_L	Lead Soldering Temperature	260 (10sec)	$^{\circ}C$
T_{STG}	Storage Temperature Range	-55 to +150	$^{\circ}C$
T_{OP}	Operating Temperature Range	-55 to +150	$^{\circ}C$
	IEC61000-4-2 (ESD)		
	Air Discharge	± 30	KV
	Contact Discharge	± 30	
	IEC61000-4-4 (EFT)	40	A
	IEC61000-4-5 (Lightning)	10	A

DFN2510P10

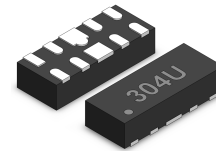

Functional Diagram

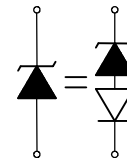
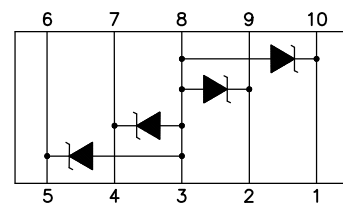

Configuration per Line

Mechanical Characteristics

- u DFN2510P10 (2.5x1.0mm) Package
- u Molding Compound Flammability Rating : UL 94V-0
- u Weight 5.0 Milligrams (Approximate)
- u Quantity Per Reel : 3,000pcs
- u Reel Size : 7 inch
- u Lead Finish : Lead Free

Transient Voltage Suppressors Array for ESD Protection

Low Capacitance

ULC3304P10

Electrical Characteristics (@ 25°C Unless Otherwise Specified)

Part Number	Device Marking	V _{RWM} (V) (Max.)	V _B (V) (Min.)	I _T (mA)	V _C @1A (Max.)	V _C		I _R (μA) (Max.)	C (pF) (Typ.)
						(Max.)	(@A)		
ULC3304P10	304U	3.3	4.0	1	6.5	15	10	1	0.5

Characteristic Curves

Fig1. 8/20μs Pulse Waveform

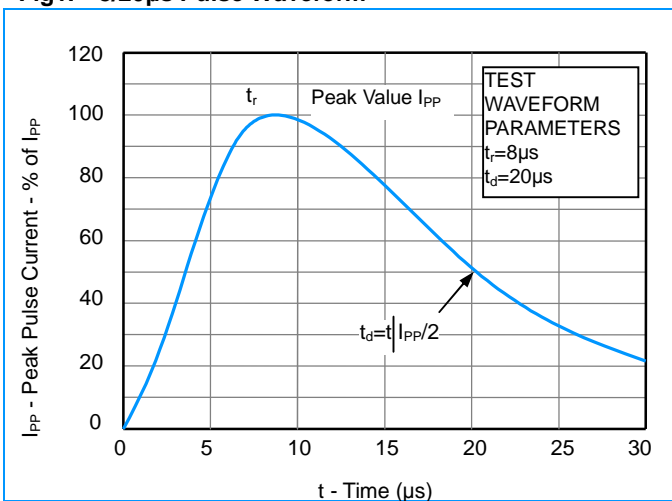

Fig2. ESD Pulse Waveform (according to IEC 61000-4-2)

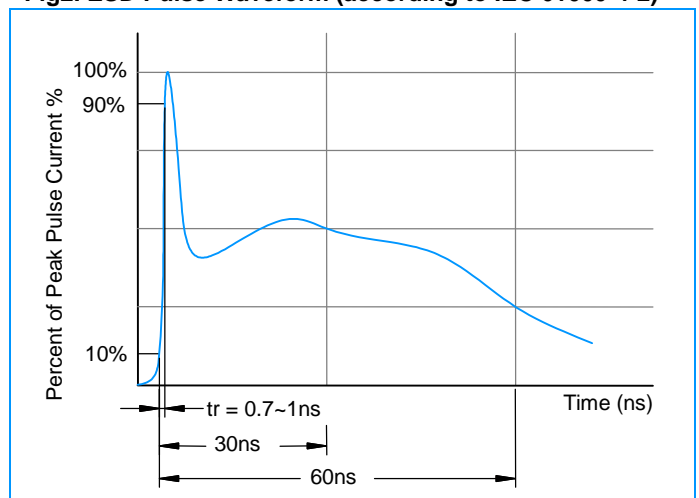

Fig3. ESD Clamping (+8KV Contac per IEC61000-4-2)

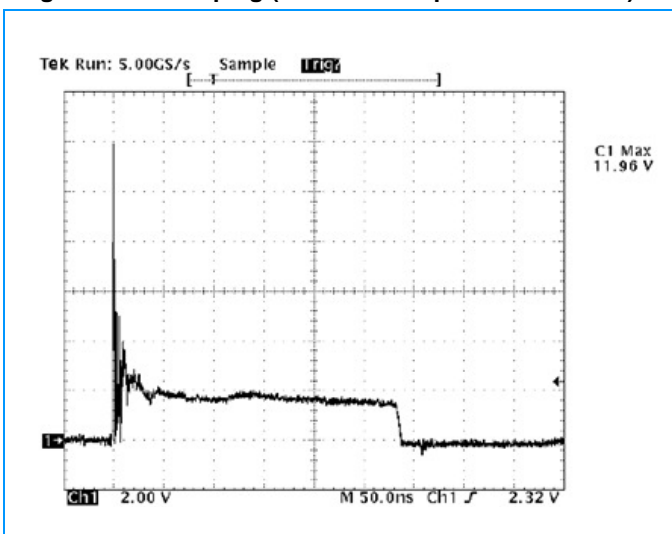
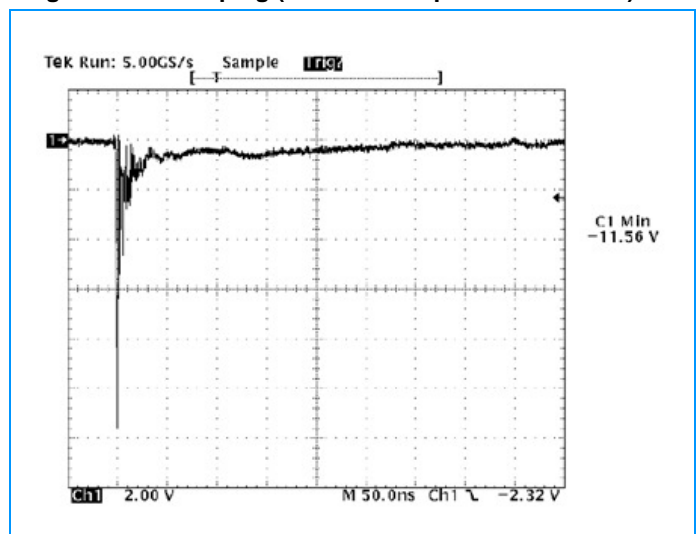

Fig4. ESD Clamping (-8KV Contac per IEC61000-4-2)



Transient Voltage Suppressors Array for ESD Protection

Low Capacitance

ULC3304P10

Transmission Line Pulse (TLP)

Transmission Line Pulse (TLP) is a measurement technique used in the Electrostatic Discharge (ESD) arena to characterize performance attributes of devices under ESD stresses. TLP is able to obtain current versus voltage (I-V) curves in which each data point is obtained with a 100 ns long pulse, with currents up to 40 A. TLP was first used in the ESD field to study human body model (HBM) in integrated circuits, but it is an equally valid tool in the field of system level ESD. The applicability of TLP to system level ESD is illustrated in Figure 1, which compares an 8 kV IEC61000-4-2 current waveform with TLP current pulses of 8 and 16 A. The current levels and time duration for the pulses are similar and the initial rise time for the TLP pulse is comparable to the rise time of the IEC61000-4-2's initial current spike. This application note will give a basic introduction to TLP measurements and explain the datasheet parameters extracted from TLP for Yeashin Technology's protection products.

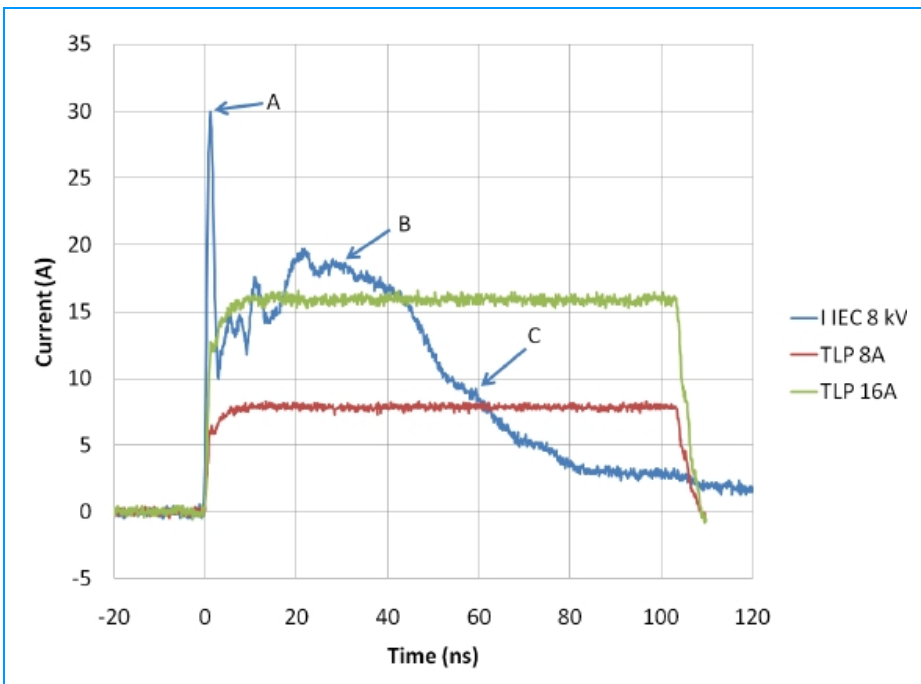

Comparison of a Current Waveform of IEC61000-4-2 with TLP Pulses at 8 and 16 A.

The IEC61000-4-2 ESD waveforms is true to the Standard and is shown here as captured on an oscilloscope. The points A, B, and C show the points on the waveforms specified in IEC61000-4-2.

	4A (tp=100ns)	8A (tp=100ns)
ULC3304P10	5.5V(typ.)	8.5V(typ.)

Transient Voltage Suppressors Array for ESD Protection

Low Capacitance

ULC3304P10

DFN2510P10 Package Outline & Dimensions

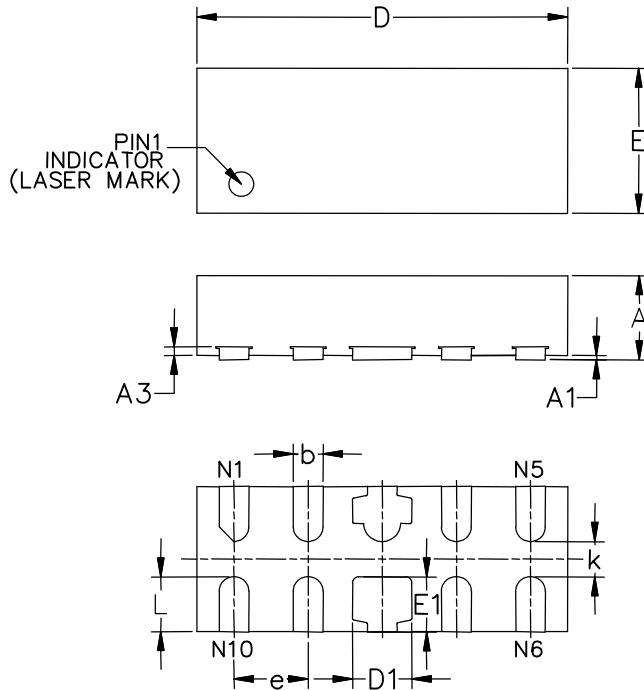

Symbol	Millimeters		Inches	
	Min.	Max.	Min.	Max.
A	0.50	0.60	0.020	0.024
A1	0.00	0.05	0.000	0.002
A3	0.11REF		0.004REF	
D	2.45	2.55	0.096	0.100
E	0.95	1.05	0.037	0.041
D1	0.35	0.45	0.014	0.018
E1	0.35	0.45	0.014	0.018
k	0.15MIN		0.006MIN	
b	0.15	0.25	0.006	0.010
e	0.50TYP.		0.020TYP.	
L	0.35	0.45	0.014	0.018

Soldering Footprint

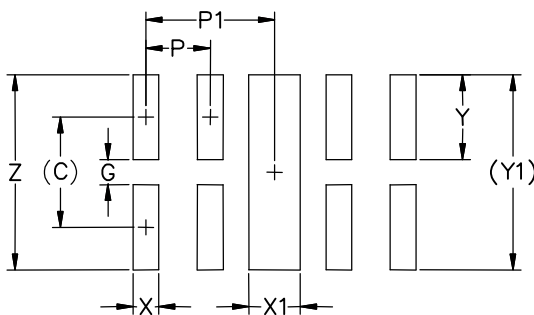

Symbol	Inches	Millimeters
C	(0.034)	(0.875)
G	0.008	0.20
P	0.020	0.50
P1	0.039	1.00
X	0.008	0.20
X1	0.016	0.40
Y	0.027	0.675
Y1	(0.061)	1.55
Z	0.061	1.55