

ULN2003A, ULQ2003A

High Voltage, High Current Darlington Transistor Arrays

The seven NPN Darlington connected transistors in these arrays are well suited for driving lamps, relays, or printer hammers in a variety of industrial and consumer applications. Their high breakdown voltage and internal suppression diodes insure freedom from problems associated with inductive loads. Peak inrush currents to 500 mA permit them to drive incandescent lamps.

The ULx2003A with a 2.7 kΩ series input resistor is well suited for systems utilizing a 5.0 V TTL or CMOS Logic.

Features

- These are Pb-Free Devices

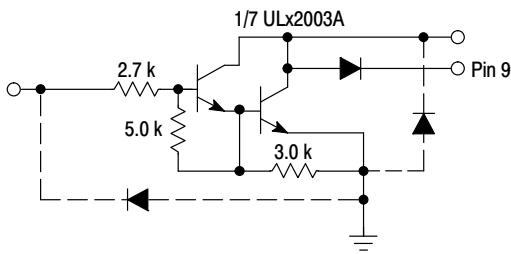
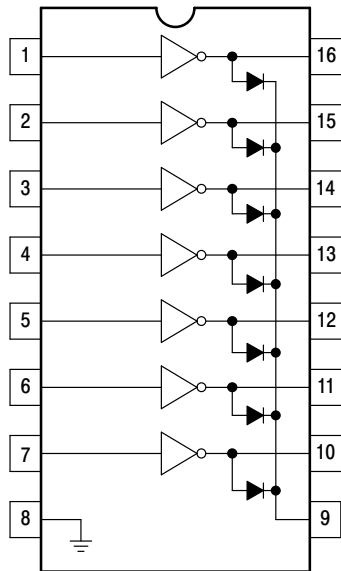

Figure 1. Representative Schematic Diagram



(Top View)

Figure 2. Pin Connections



ON Semiconductor®

<http://onsemi.com>

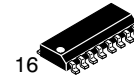

16
1
SOIC-16
D SUFFIX
CASE 751B

MARKING DIAGRAMS

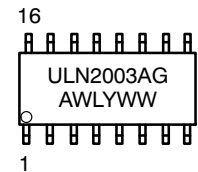

A = Assembly Location
WL = Wafer Lot
Y = Year
WW = Work Week
G = Pb-Free Package

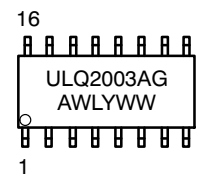

ORDERING INFORMATION

Device	Package	Shipping†
ULN2003ADR2G	SOIC-16 (Pb-Free)	2500 Tape & Reel
ULQ2003ADR2G	SOIC-16 (Pb-Free)	2500 Tape & Reel

†For information on tape and reel specifications, including part orientation and tape sizes, please refer to our Tape and Reel Packaging Specifications Brochure, BRD8011/D.

ULN2003A, ULQ2003A

MAXIMUM RATINGS ($T_A = 25^\circ\text{C}$, and rating apply to any one device in the package, unless otherwise noted.)

Rating	Symbol	Value	Unit
Output Voltage	V_O	50	V
Input Voltage	V_I	30	V
Collector Current - Continuous	I_C	500	mA
Base Current - Continuous	I_B	25	mA
Operating Ambient Temperature Range ULN2003A ULQ2003A	T_A	-20 to +85 -40 to +85	$^\circ\text{C}$
Storage Temperature Range	T_{stg}	-55 to +150	$^\circ\text{C}$
Junction Temperature	T_J	150	$^\circ\text{C}$
Thermal Resistance, Junction-to-Ambient Case 751B, D Suffix	$R_{\theta JA}$	100	$^\circ\text{C}/\text{W}$
Thermal Resistance, Junction-to-Case Case 751B, D Suffix	$R_{\theta JC}$	20	$^\circ\text{C}/\text{W}$
Electrostatic Discharge Sensitivity (ESD) Human Body Model (HBM) Machine Model (MM) Charged Device Model (CDM)	ESD	2000 400 1500	V

Stresses exceeding Maximum Ratings may damage the device. Maximum Ratings are stress ratings only. Functional operation above the Recommended Operating Conditions is not implied. Extended exposure to stresses above the Recommended Operating Conditions may affect device reliability.

ULN2003A, ULQ2003A

ELECTRICAL CHARACTERISTICS (T_A = 25°C, unless otherwise noted)

Characteristic	Symbol	Min	Typ	Max	Unit
Output Leakage Current (V _O = 50 V, T _A = +85°C) (V _O = 50 V, T _A = +25°C)	I _{CEX}	- -	- -	100 50	μA
Collector-Emitter Saturation Voltage (I _C = 350 mA, I _B = 500 μA) (I _C = 200 mA, I _B = 350 μA) (I _C = 100 mA, I _B = 250 μA)	V _{CE(sat)}	- - -	1.1 0.95 0.85	1.6 1.3 1.1	V
Input Current - On Condition (V _I = 3.85 V)	I _{I(on)}	-	0.93	1.35	mA
Input Voltage - On Condition (V _{CE} = 2.0 V, I _C = 200 mA) (V _{CE} = 2.0 V, I _C = 250 mA) (V _{CE} = 2.0 V, I _C = 300 mA)	V _{I(on)}	- - -	- - -	2.4 2.7 3.0	V
Input Current - Off Condition (I _C = 500 μA, T _A = 85°C)	I _{I(off)}	50	100	-	μA
DC Current Gain (V _{CE} = 2.0 V, I _C = 350 mA)	h _{FE}	1000	-	-	-
Input Capacitance	C _I	-	15	30	pF
Turn-On Delay Time (50% E _I to 50% E _O)	t _{on}	-	0.25	1.0	μs
Turn-Off Delay Time (50% E _I to 50% E _O)	t _{off}	-	0.25	1.0	μs
Clamp Diode Leakage Current (V _R = 50 V)	I _R	- -	- -	50 100	μA
Clamp Diode Forward Voltage (I _F = 350 mA)	V _F	-	1.5	2.0	V

ULN2003A, ULQ2003A

TYPICAL PERFORMANCE CURVES - $T_A = 25^\circ\text{C}$

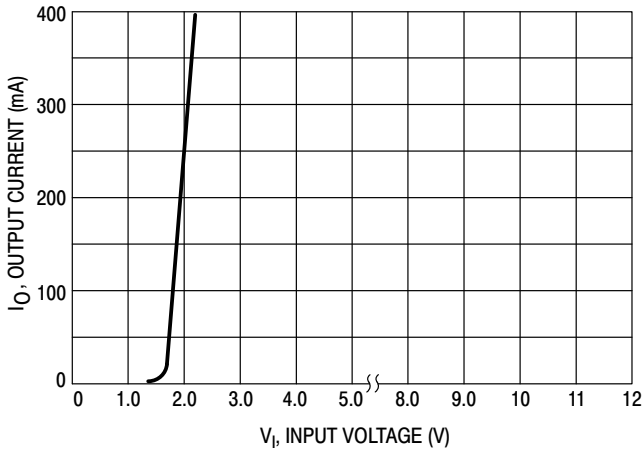

Figure 3. Output Current versus Input Voltage

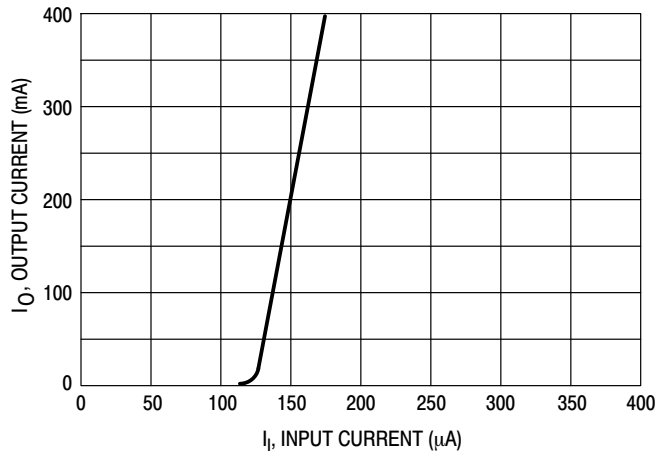

Figure 4. Output Current versus Input Current

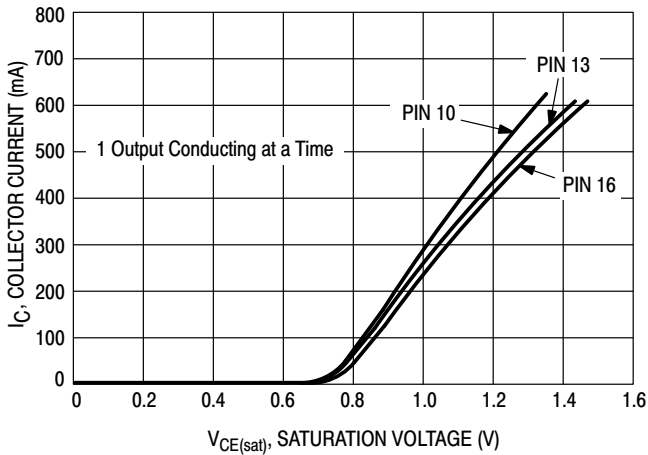

Figure 5. Typical Output Characteristics

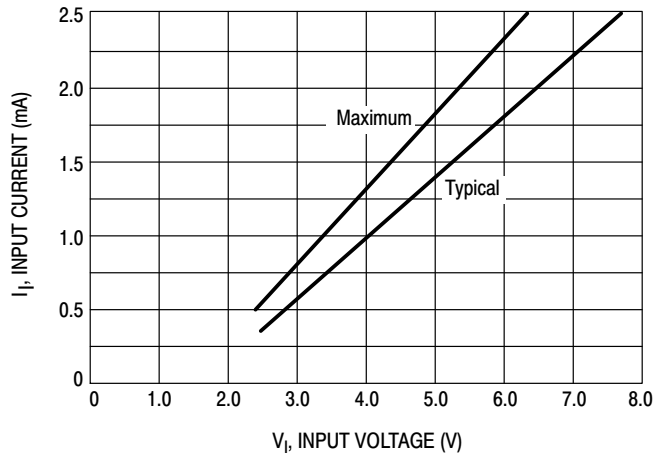

Figure 6. Input Characteristics

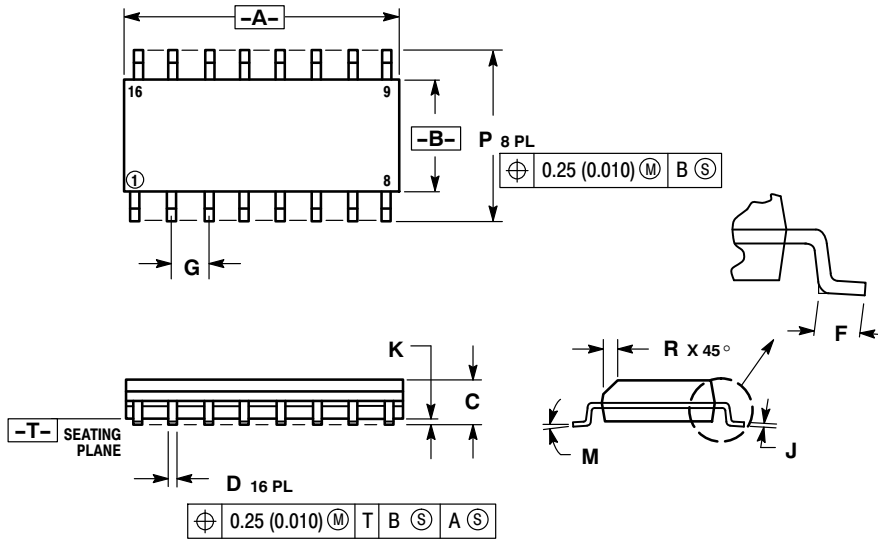

Figure 7. Maximum Collector Current versus Duty Cycle (and Number of Drivers in Use)

ULN2003A, ULQ2003A

PACKAGE DIMENSIONS

SOIC-16
D SUFFIX
CASE 751B-05
ISSUE K



NOTES:

1. DIMENSIONING AND TOLERANCING PER ANSI Y14.5M, 1982.
2. CONTROLLING DIMENSION: MILLIMETER.
3. DIMENSIONS A AND B DO NOT INCLUDE MOLD PROTRUSION.
4. MAXIMUM MOLD PROTRUSION 0.15 (0.006) PER SIDE.
5. DIMENSION D DOES NOT INCLUDE DAMBAR PROTRUSION. ALLOWABLE DAMBAR PROTRUSION SHALL BE 0.127 (0.005) TOTAL IN EXCESS OF THE D DIMENSION AT MAXIMUM MATERIAL CONDITION.

DIM	MILLIMETERS		INCHES	
	MIN	MAX	MIN	MAX
A	9.80	10.00	0.386	0.393
B	3.80	4.00	0.150	0.157
C	1.35	1.75	0.054	0.068
D	0.35	0.49	0.014	0.019
F	0.40	1.25	0.016	0.049
G	1.27 BSC		0.050 BSC	
J	0.19	0.25	0.008	0.009
K	0.10	0.25	0.004	0.009
M	0°	7°	0°	7°
P	5.80	6.20	0.229	0.244
R	0.25	0.50	0.010	0.019

SOLDERING FOOTPRINT*

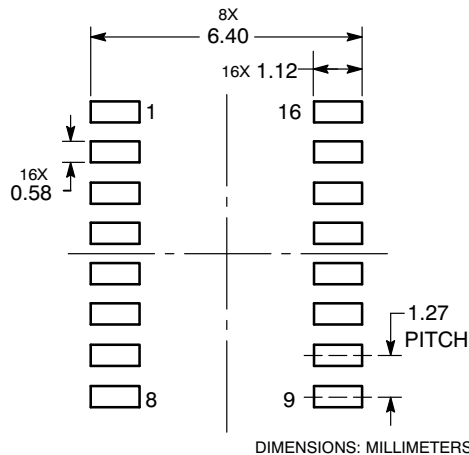

DIMENSIONS: MILLIMETERS

*For additional information on our Pb-Free strategy and soldering details, please download the ON Semiconductor Soldering and Mounting Techniques Reference Manual, SOLDERRM/D.

ON Semiconductor and are registered trademarks of Semiconductor Components Industries, LLC (SCILLC). SCILLC reserves the right to make changes without further notice to any products herein. SCILLC makes no warranty, representation or guarantee regarding the suitability of its products for any particular purpose, nor does SCILLC assume any liability arising out of the application or use of any product or circuit, and specifically disclaims any and all liability, including without limitation special, consequential or incidental damages. "Typical" parameters which may be provided in SCILLC data sheets and/or specifications can and do vary in different applications and actual performance may vary over time. All operating parameters, including "Typicals" must be validated for each customer application by customer's technical experts. SCILLC does not convey any license under its patent rights nor the rights of others. SCILLC products are not designed, intended, or authorized for use as components in systems intended for surgical implant into the body, or other applications intended to support or sustain life, or for any other application in which the failure of the SCILLC product could create a situation where personal injury or death may occur. Should Buyer purchase or use SCILLC products for any such unintended or unauthorized application, Buyer shall indemnify and hold SCILLC and its officers, employees, subsidiaries, affiliates, and distributors harmless against all claims, costs, damages, and expenses, and reasonable attorney fees arising out of, directly or indirectly, any claim of personal injury or death associated with such unintended or unauthorized use, even if such claim alleges that SCILLC was negligent regarding the design or manufacture of the part. SCILLC is an Equal Opportunity/Affirmative Action Employer. This literature is subject to all applicable copyright laws and is not for resale in any manner.

PUBLICATION ORDERING INFORMATION

LITERATURE FULFILLMENT:
Literature Distribution Center for ON Semiconductor
P.O. Box 5163, Denver, Colorado 80217 USA
Phone: 303-675-2175 or 800-344-3860 Toll Free USA/Canada
Fax: 303-675-2176 or 800-344-3867 Toll Free USA/Canada
Email: orderlit@onsemi.com

N. American Technical Support: 800-282-9855 Toll Free USA/Canada
Europe, Middle East and Africa Technical Support:
Phone: 421 33 790 2910
Japan Customer Focus Center
Phone: 81-3-5773-3850

ON Semiconductor Website: www.onsemi.com

Order Literature: <http://www.onsemi.com/orderlit>

For additional information, please contact your local Sales Representative