

SERIES ULS-2800H AND ULS-2800R HIGH-VOLTAGE, HIGH-CURRENT DARLINGTON ARRAYS

MIL-STD-883 Compliant

FEATURES

- TTL, DTL, PMOS, or CMOS Compatible Inputs
- Peak Output Current to 600 mA
- Transient-Protected Outputs
- Side-Brazed Hermetic Package
- Cer-DIP Hermetic Package
- High-Reliability Screening to MIL-STD-883, Class B
- -55°C to +125°C Temperature Range

DESIGNED TO SERVE as interface between low-level logic circuitry and high-power loads, Series ULS-2800H and ULS-2800R arrays consist of eight silicon NPN Darlington power drivers on a common monolithic substrate. They are ideally suited to driving relays, solenoids, lamps, and other devices in high-reliability military or aerospace applications with up to 3 A output current per package.

These devices are screened to MIL-STD-883, Class B and are supplied in either the popular glass/metal side-brazed 18-pin hermetic package (suffix 'H') or ceramic/glass cer-DIP hermetic package (suffix 'R'). Both package styles conform to the dimensional requirements of MIL-M-38510 and are rated for operation over the full military temperature range of -55°C to +125°C. Reverse-bias burn-in and 100% high-reliability screening are standard.

The 30 integrated circuits described in this bulletin permit the circuit designer to select the optimal device for any application. In addition to the two package styles, there are five input characteristics, two output-voltage ratings, and two output-current ratings. The appropriate part for specific applications can be determined from the Device Part Number Designation chart. All units have open-collector outputs and on-chip diodes for inductive-load transient suppression.

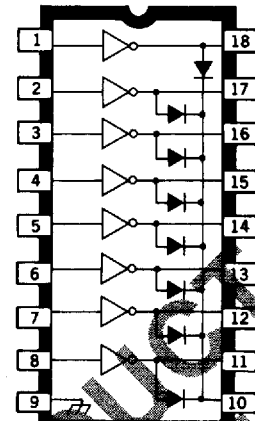

Dwg. No. A-11322

Device Part Number Designation

$V_{CE(MAX)}$	50 V	50 V	95 V
$I_{C(MAX)}$	500 mA	600 mA	500 mA

	Part Number		
General Purpose PMOS, CMOS	ULS-2801*	ULS-2811*	ULS-2821*
14-25 V PMOS	ULS-2802*	ULS-2812*	ULS-2822*
5 V TTL, CMOS	ULS-2803*	ULS-2813*	ULS-2823*
6-15 V CMOS, PMOS	ULS-2804*	ULS-2814*	ULS-2824*
High-Output TTL	ULS-2805*	ULS-2815*	ULS-2825*

*Complete part number includes a final letter to indicate package (H = glass/metal side-brazed, R = ceramic/glass cer-DIP)

SERIES ULS-2800H AND ULS-2800R HIGH-VOLTAGE, HIGH-CURRENT DARLINGTON ARRAYS

ABSOLUTE MAXIMUM RATINGS

Output Voltage, V_{CE}	
(ULS-280X*, ULS-281X*)	50 V
(ULS-282X*)	95 V
Input Voltage, V_{IN}	
(ULS-28X2, X3, X4*)	30 V
(ULS-28X5*)	15 V
Peak Output Current, I_{OUT}	
(ULS-280X*, ULS-282X*)	500 mA
(ULS-281X*)	600 mA
Ground Terminal Current, I_{GND}	3.0 A
Continuous Input Current, I_{IN}	25 mA
Power Dissipation, P_D	
(one Darlington pair)	1.0 W
(total package)	See Graph
Operating Temperature Range, T_A	-55°C to +125°C
Storage Temperature Range, T_S	-65°C to +150°C

ALLOWABLE PACKAGE POWER DISSIPATION

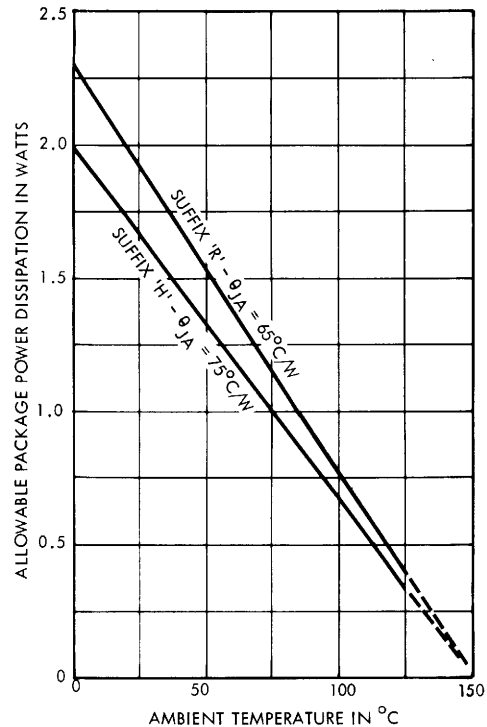

Dwg. No. A-10,879A

PARTIAL SCHEMATICS

ULS-28X1*
(Each Driver)

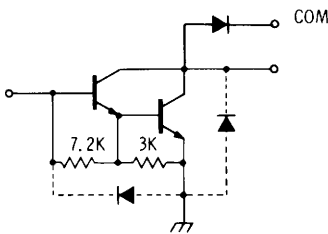

Dwg. No. A-9595

ULS-28X2*
(Each Driver)

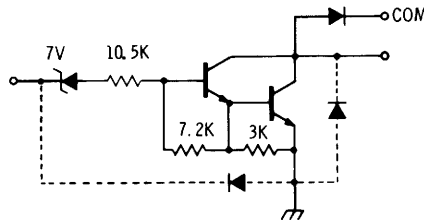

DWG. No. A-9650

Dwg. No. A-9650

ULS-28X3*
(Each Driver)

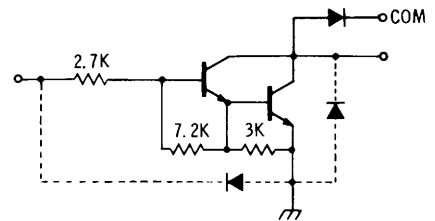

DWG. No. A-9651

Dwg. No. A-9651

ULS-28X4*
(Each Driver)

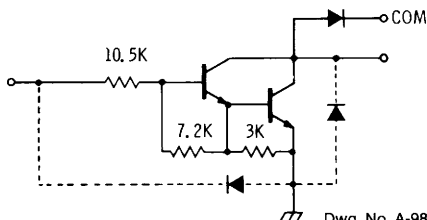

Dwg. No. A-9898A

ULS-28X5*
(Each Driver)

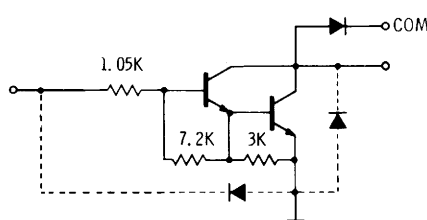

Dwg. No. A-10,228

*Complete part number includes a final letter to indicate package (H = glass/metal side-brazed, R = ceramic/glass cer-DIP).
X = digit to identify specific device. Specification or limit shown applies to family of devices with remaining digits as shown.

SERIES ULS-2800H AND ULS-2800R

ELECTRICAL CHARACTERISTICS over operating temperature range (unless otherwise noted)

Characteristic	Symbol	Applicable Devices	Test Conditions			Limits			
			Temp.	Voltage/Current	Fig.	Min.	Typ.	Max.	Units
Output Leakage Current	I_{CEX}	All		$V_{CE} = 50\text{ V}$	1A	—	—	100	μA
		ULS-2802*		$V_{CE} = 50\text{ V}, V_{IN} = 6\text{ V}$	1B	—	—	500	μA
		ULS-2804*		$V_{CE} = 50\text{ V}, V_{IN} = 1\text{ V}$	1B	—	—	500	μA
Collector-Emitter Saturation Voltage	$V_{CE(SAT)}$	All	- 55°C	$I_C = 350\text{ mA}, I_B = 850\ \mu\text{A}$	2	—	1.6	1.8	V
				$I_C = 200\text{ mA}, I_B = 550\ \mu\text{A}$	2	—	1.3	1.5	V
				$I_C = 100\text{ mA}, I_B = 350\ \mu\text{A}$	2	—	1.1	1.3	V
			+ 25°C	$I_C = 350\text{ mA}, I_B = 500\ \mu\text{A}$	2	—	1.25	1.6	V
				$I_C = 200\text{ mA}, I_B = 350\ \mu\text{A}$	2	—	1.1	1.3	V
				$I_C = 100\text{ mA}, I_B = 250\ \mu\text{A}$	2	—	0.9	1.1	V
			+ 125°C	$I_C = 350\text{ mA}\dagger, I_B = 500\ \mu\text{A}$	2	—	1.6	1.8	V
				$I_C = 200\text{ mA}, I_B = 350\ \mu\text{A}$	2	—	1.3	1.5	V
				$I_C = 100\text{ mA}, I_B = 250\ \mu\text{A}$	2	—	1.1	1.3	V
Input Current	$I_{IN(ON)}$	ULS-2802*		$V_{IN} = 17\text{ V}$	3	480	850	1300	μA
		ULS-2803*		$V_{IN} = 3.85\text{ V}$	3	650	930	1350	μA
		ULS-2804*		$V_{IN} = 5.0\text{ V}$	3	240	350	500	μA
				$V_{IN} = 12\text{ V}$	3	650	1000	1450	μA
		ULS-2805*		$V_{IN} = 3.0\text{ V}$	3	—	1500	2400	μA
Input Voltage	$V_{IN(OFF)}$	All	+ 125°C	$I_C = 500\ \mu\text{A}$	4	25	50	—	μA
		ULS-2802*	- 55°C	$V_{CE} = 2.0\text{ V}, I_C = 300\text{ mA}$	5	—	—	18	V
+ 125°C	$V_{CE} = 2.0\text{ V}, I_C = 300\text{ mA}$			5	—	—	13	V	
ULS-2803*	- 55°C		$V_{CE} = 2.0\text{ V}, I_C = 200\text{ mA}$	5	—	—	3.3	V	
			$V_{CE} = 2.0\text{ V}, I_C = 250\text{ mA}$	5	—	—	3.6	V	
			$V_{CE} = 2.0\text{ V}, I_C = 300\text{ mA}$	5	—	—	3.9	V	
+ 125°C	$V_{CE} = 2.0\text{ V}, I_C = 200\text{ mA}\dagger$		5	—	—	2.4	V		
	$V_{CE} = 2.0\text{ V}, I_C = 250\text{ mA}\dagger$		5	—	—	2.7	V		
	$V_{CE} = 2.0\text{ V}, I_C = 300\text{ mA}\dagger$		5	—	—	3.0	V		
ULS-2804*	- 55°C		$V_{CE} = 2.0\text{ V}, I_C = 125\text{ mA}$	5	—	—	6.0	V	
			$V_{CE} = 2.0\text{ V}, I_C = 200\text{ mA}$	5	—	—	8.0	V	
			$V_{CE} = 2.0\text{ V}, I_C = 275\text{ mA}$	5	—	—	10	V	
	+ 125°C		$V_{CE} = 2.0\text{ V}, I_C = 350\text{ mA}$	5	—	—	12	V	
			$V_{CE} = 2.0\text{ V}, I_C = 125\text{ mA}$	5	—	—	5.0	V	
			$V_{CE} = 2.0\text{ V}, I_C = 200\text{ mA}\dagger$	5	—	—	6.0	V	
ULS-2805*	- 55°C		$V_{CE} = 2.0\text{ V}, I_C = 275\text{ mA}\dagger$	5	—	—	7.0	V	
			$V_{CE} = 2.0\text{ V}, I_C = 350\text{ mA}\dagger$	5	—	—	8.0	V	
			$V_{CE} = 2.0\text{ V}, I_C = 350\text{ mA}\dagger$	5	—	—	3.0	V	
D-C Forward Current Transfer Ratio	h_{FE}		ULS2801*	- 55°C	$V_{CE} = 2.0\text{ V}, I_C = 350\text{ mA}$	2	500	—	—
		+ 25°C		$V_{CE} = 2.0\text{ V}, I_C = 350\text{ mA}$	2	1000	—	—	—
Turn-On Delay	t_{PLH}	All	+ 25°C		8	—	250	1000	ns
Turn-Off Delay	t_{PHL}	All	+ 25°C		8	—	250	1000	ns
Clamp Diode Leakage Current	I_R	All		$V_R = 50\text{ V}$	6	—	—	50	μA
Clamp Diode Forward Voltage	V_f	All		$I_f = 350\text{ mA}\dagger$	7	—	1.7	2.0	V

*Complete part number includes a final letter to indicate package (H = glass/metal side-braced, R = ceramic/glass cer-DIP).

Note 1: All limits stated apply to the complete Darlington series except as specified for a single device type.

Note 2: The $I_{IN(OFF)}$ current limit guarantees against partial turn-on of the output.

Note 3: The $V_{IN(ON)}$ voltage limit guarantees a minimum output sink current per the specified test conditions.

†Pulse Test, $t_p \leq 1\ \mu\text{s}$, see graph.

**SERIES ULS-2800H AND ULS-2800R
HIGH-VOLTAGE, HIGH-CURRENT DARLINGTON ARRAYS**

SERIES ULS-2810H AND ULS-2810R

ELECTRICAL CHARACTERISTICS over operating temperature range (unless otherwise noted)

Characteristic	Symbol	Applicable Devices	Test Conditions			Limits			
			Temp.	Voltage/Current	Fig.	Min.	Typ.	Max.	Units
Output Leakage Current	I_{CEX}	All		$V_{CE} = 50\text{ V}$	1A	—	—	100	μA
		ULS-2812*		$V_{CE} = 50\text{ V}, V_{IN} = 6\text{ V}$	1B	—	—	500	μA
		ULS-2814*		$V_{CE} = 50\text{ V}, V_{IN} = 1\text{ V}$	1B	—	—	500	μA
Collector-Emitter Saturation Voltage	$V_{CE(SAT)}$	All	-55°C	$I_C = 500\text{ mA}, I_B = 1100\ \mu\text{A}$	2	—	1.8	2.1	V
				$I_C = 350\text{ mA}, I_B = 850\ \mu\text{A}$	2	—	1.6	1.8	V
				$I_C = 200\text{ mA}, I_B = 550\ \mu\text{A}$	2	—	1.3	1.5	V
			+25°C	$I_C = 500\text{ mA}, I_B = 600\ \mu\text{A}$	2	—	1.7	1.9	V
				$I_C = 350\text{ mA}, I_B = 500\ \mu\text{A}$	2	—	1.25	1.6	V
				$I_C = 200\text{ mA}, I_B = 350\ \mu\text{A}$	2	—	1.1	1.3	V
			+125°C	$I_C = 500\text{ mA}^\dagger, I_B = 600\ \mu\text{A}$	2	—	1.8	2.1	V
				$I_C = 350\text{ mA}^\dagger, I_B = 500\ \mu\text{A}$	2	—	1.6	1.8	V
				$I_C = 200\text{ mA}, I_B = 350\ \mu\text{A}$	2	—	1.3	1.5	V
Input Current	$I_{IN(ON)}$	ULS-2812*		$V_{IN} = 17\text{ V}$	3	480	850	1300	μA
		ULS-2813*		$V_{IN} = 3.85\text{ V}$	3	650	930	1350	μA
		ULS-2814*		$V_{IN} = 5.0\text{ V}$	3	240	350	500	μA
				$V_{IN} = 12\text{ V}$	3	650	1000	1450	μA
		ULS-2815*		$V_{IN} = 3.0\text{ V}$	3	—	1500	2400	μA
	$I_{IN(OFF)}$	All	+125°C	$I_C = 500\ \mu\text{A}$	4	25	50	—	μA
Input Voltage	$V_{IN(ON)}$	ULS-2812*	-55°C	$V_{CE} = 2.0\text{ V}, I_C = 500\text{ mA}$	5	—	—	23.5	V
			+125°C	$V_{CE} = 2.0\text{ V}, I_C = 500\text{ mA}$	5	—	—	17	V
		ULS-2013*	-55°C	$V_{CE} = 2.0\text{ V}, I_C = 250\text{ mA}$	5	—	—	3.6	V
				$V_{CE} = 2.0\text{ V}, I_C = 300\text{ mA}$	5	—	—	3.9	V
				$V_{CE} = 2.0\text{ V}, I_C = 500\text{ mA}$	5	—	—	6.0	V
			+125°C	$V_{CE} = 2.0\text{ V}, I_C = 250\text{ mA}^\dagger$	5	—	—	2.7	V
				$V_{CE} = 2.0\text{ V}, I_C = 300\text{ mA}^\dagger$	5	—	—	3.0	V
				$V_{CE} = 2.0\text{ V}, I_C = 500\text{ mA}^\dagger$	5	—	—	3.5	V
		ULS-2814*	-55°C	$V_{CE} = 2.0\text{ V}, I_C = 275\text{ mA}$	5	—	—	10	V
				$V_{CE} = 2.0\text{ V}, I_C = 350\text{ mA}$	5	—	—	12	V
				$V_{CE} = 2.0\text{ V}, I_C = 500\text{ mA}$	5	—	—	17	V
			+125°C	$V_{CE} = 2.0\text{ V}, I_C = 275\text{ mA}^\dagger$	5	—	—	7.0	V
				$V_{CE} = 2.0\text{ V}, I_C = 350\text{ mA}^\dagger$	5	—	—	8.0	V
				$V_{CE} = 2.0\text{ V}, I_C = 500\text{ mA}^\dagger$	5	—	—	9.5	V
		ULS-2815*	-55°C	$V_{CE} = 2.0\text{ V}, I_C = 350\text{ mA}$	5	—	—	3.0	V
				$V_{CE} = 2.0\text{ V}, I_C = 500\text{ mA}$	5	—	—	3.5	V
			+125°C	$V_{CE} = 2.0\text{ V}, I_C = 350\text{ mA}^\dagger$	5	—	—	2.4	V
				$V_{CE} = 2.0\text{ V}, I_C = 500\text{ mA}^\dagger$	5	—	—	2.6	V
D-C Forward Current Transfer Ratio	h_{FE}	ULS-2811*	-55°C	$V_{CE} = 2.0\text{ V}, I_C = 500\text{ mA}$	2	450	—	—	—
			+25°C	$V_{CE} = 2.0\text{ V}, I_C = 500\text{ mA}$	2	900	—	—	—
Turn-On Delay	t_{PLH}	All	+25°C		8	—	250	1000	ns
Turn-Off Delay	t_{PHL}	All	+25°C		8	—	250	1000	ns
Clamp Diode Leakage Current	I_R	All		$V_R = 50\text{ V}$	6	—	—	50	μA
Clamp Diode Forward Voltage	V_f	All		$I_f = 350\text{ mA}^\dagger$	7	—	1.7	2.0	V
				$I_f = 500\text{ mA}^\dagger$	7	—	—	2.5	V

*Complete part number includes a final letter to indicate package (H = glass/metal side-brazed, R = ceramic/glass cer-DIP).

Note 1: All limits stated apply to the complete Darlington series except as specified for a single device type.

Note 2: The $I_{IN(OFF)}$ current limit guarantees against partial turn-on of the output.

Note 3: The $V_{IN(ON)}$ voltage limit guarantees a minimum output sink current per the specified test conditions.

†Pulse Test, $t_p \leq 1\ \mu\text{s}$, see graph.

SERIES ULS-2820H AND ULS-2820R
ELECTRICAL CHARACTERISTICS over operating temperature range (unless otherwise noted)

Characteristic	Symbol	Applicable Devices	Test Conditions			Limits				
			Temp.	Voltage/Current	Fig.	Min.	Typ.	Max.	Units	
Output Leakage Current	I_{CEX}	All		$V_{CE} = 95\text{ V}$	1A	—	—	100	μA	
		ULS-2822*		$V_{CE} = 95\text{ V}, V_{IN} = 6\text{ V}$	1B	—	—	500	μA	
		ULS-2824*	25°C	$V_{CE} = 95\text{ V}, V_{IN} = 1\text{ V}$	1B	—	—	500	μA	
			+125°C	$V_{CE} = 95\text{ V}, V_{IN} = 0.5\text{ V}$	1B	—	—	500	μA	
Collector-Emitter Saturation Voltage	$V_{CE(SAT)}$	All	-55°C	$I_C = 350\text{ mA}, I_B = 850\ \mu\text{A}$	2	—	1.6	1.8	V	
				$I_C = 200\text{ mA}, I_B = 550\ \mu\text{A}$	2	—	1.3	1.5	V	
				$I_C = 100\text{ mA}, I_B = 350\ \mu\text{A}$	2	—	1.1	1.3	V	
			+25°C	$I_C = 350\text{ mA}, I_B = 500\ \mu\text{A}$	2	—	1.25	1.6	V	
				$I_C = 200\text{ mA}, I_B = 350\ \mu\text{A}$	2	—	1.1	1.3	V	
				$I_C = 100\text{ mA}, I_B = 250\ \mu\text{A}$	2	—	0.9	1.1	V	
			+125°C	$I_C = 350\text{ mA}\dagger, I_B = 500\ \mu\text{A}$	2	—	1.6	1.8	V	
				$I_C = 200\text{ mA}, I_B = 350\ \mu\text{A}$	2	—	1.3	1.5	V	
				$I_C = 100\text{ mA}, I_B = 250\ \mu\text{A}$	2	—	1.1	1.3	V	
Input Current	$I_{IN(ON)}$	ULS-2822*		$V_{IN} = 17\text{ V}$	3	480	850	1300	μA	
		ULS-2823*		$V_{IN} = 3.85\text{ V}$	3	650	930	1350	μA	
		ULS-2824*		$V_{IN} = 5.0\text{ V}$	3	240	350	500	μA	
				$V_{IN} = 12\text{ V}$	3	650	1000	1450	μA	
		ULS-2825*		$V_{IN} = 3.0\text{ V}$	3	—	1500	2400	μA	
	$I_{IN(OFF)}$	All	+125°C	$I_C = 500\ \mu\text{A}$	4	20	50	—	μA	
Input Voltage	$V_{IN(ON)}$	ULS-2822*	-55°C	$V_{CE} = 2.0\text{ V}, I_C = 300\text{ mA}$	5	—	—	18	V	
				$V_{CE} = 2.0\text{ V}, I_C = 300\text{ mA}$	5	—	—	13	V	
			ULS-2823*	-55°C	$V_{CE} = 2.0\text{ V}, I_C = 200\text{ mA}$	5	—	—	3.3	V
					$V_{CE} = 2.0\text{ V}, I_C = 250\text{ mA}$	5	—	—	3.6	V
					$V_{CE} = 2.0\text{ V}, I_C = 300\text{ mA}$	5	—	—	3.9	V
			+125°C	$V_{CE} = 2.0\text{ V}, I_C = 200\text{ mA}\dagger$	5	—	—	2.4	V	
		$V_{CE} = 2.0\text{ V}, I_C = 250\text{ mA}\dagger$		5	—	—	2.7	V		
		$V_{CE} = 2.0\text{ V}, I_C = 300\text{ mA}\dagger$		5	—	—	3.0	V		
		ULS-2824*	-55°C	$V_{CE} = 2.0\text{ V}, I_C = 125\text{ mA}$	5	—	—	6.0	V	
				$V_{CE} = 2.0\text{ V}, I_C = 200\text{ mA}$	5	—	—	8.0	V	
				$V_{CE} = 2.0\text{ V}, I_C = 275\text{ mA}$	5	—	—	10	V	
				$V_{CE} = 2.0\text{ V}, I_C = 350\text{ mA}$	5	—	—	12	V	
			+125°C	$V_{CE} = 2.0\text{ V}, I_C = 125\text{ mA}$	5	—	—	5.0	V	
				$V_{CE} = 2.0\text{ V}, I_C = 200\text{ mA}\dagger$	5	—	—	6.0	V	
				$V_{CE} = 2.0\text{ V}, I_C = 275\text{ mA}\dagger$	5	—	—	7.0	V	
				$V_{CE} = 2.0\text{ V}, I_C = 350\text{ mA}\dagger$	5	—	—	8.0	V	
		ULS-2825*	-55°C	$V_{CE} = 2.0\text{ V}, I_C = 350\text{ mA}$	5	—	—	3.0	V	
			+125°C	$V_{CE} = 2.0\text{ V}, I_C = 350\text{ mA}\dagger$	5	—	—	2.4	V	
D-C Forward Current Transfer Ratio	h_{FE}	ULS2821*	-55°C	$V_{CE} = 2.0\text{ V}, I_C = 350\text{ mA}$	2	500	—	—	—	
			+25°C	$V_{CE} = 2.0\text{ V}, I_C = 350\text{ mA}$	2	1000	—	—	—	
Turn-On Delay	t_{PLH}	All	+25°C		8	—	250	1000	ns	
Turn-Off Delay	t_{PHL}	All	+25°C		8	—	250	1000	ns	
Clamp Diode Leakage Current	I_R	All		$V_R = 95\text{ V}$	6	—	—	50	μA	
Clamp Diode Forward Voltage	V_f	All		$I_f = 350\text{ mA}\dagger$	7	—	1.7	2.0	V	

*Complete part number includes a final letter to indicate package (H = glass/metal side-brazed, R = ceramic/glass cer-DIP).

Note 1: All limits stated apply to the complete Darlington series except as specified for a single device type.

Note 2: The $I_{IN(OFF)}$ current limit guarantees against partial turn-on of the output.

Note 3: The $V_{IN(ON)}$ voltage limit guarantees a minimum output sink current per the specified test conditions.

†Pulse Test, $t_p \leq 1\ \mu\text{s}$, see graph.

**SERIES ULS-2800H AND ULS-2800R
HIGH-VOLTAGE, HIGH-CURRENT DARLINGTON ARRAYS**

TEST FIGURES

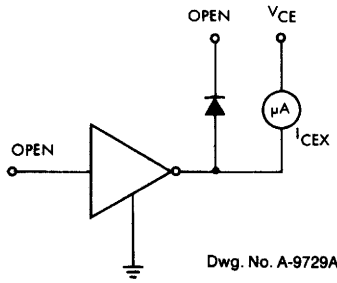

FIGURE 1A

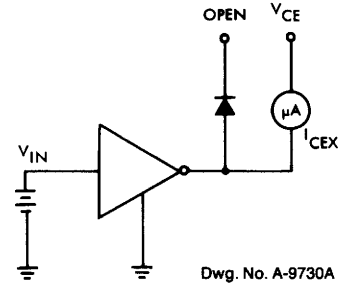

FIGURE 1B

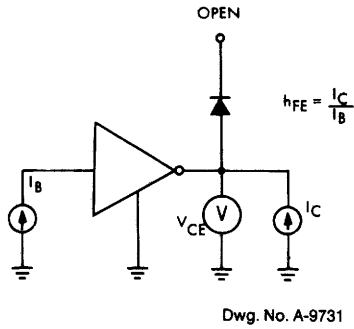

FIGURE 2

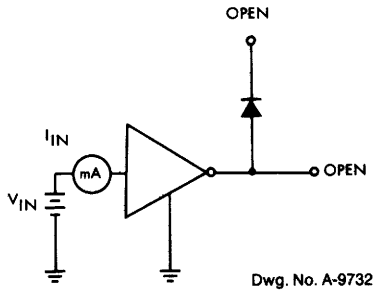

FIGURE 3

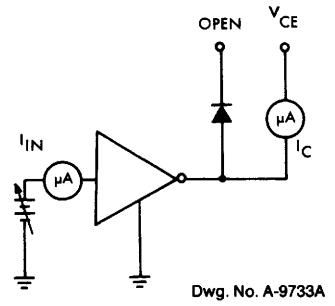

FIGURE 4

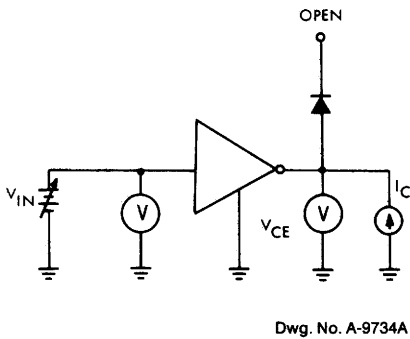

FIGURE 5

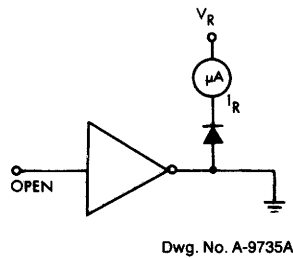

FIGURE 6

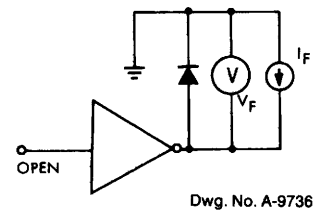
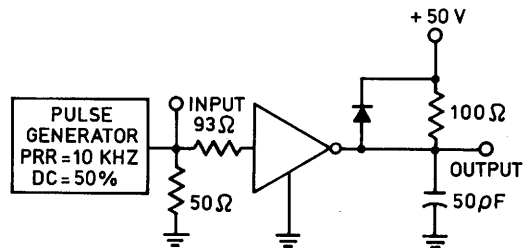

FIGURE 7

**SERIES ULS-2800H AND ULS-2800R
HIGH-VOLTAGE, HIGH-CURRENT DARLINGTON ARRAYS**

	V_{in}
ULS-28X1*	3.5 V
ULS-28X2*	13 V
ULS-28X3*	3.5 V
ULS-28X4*	12 V
ULS-28X5*	3.5 V



Dwg. No. A-13,273

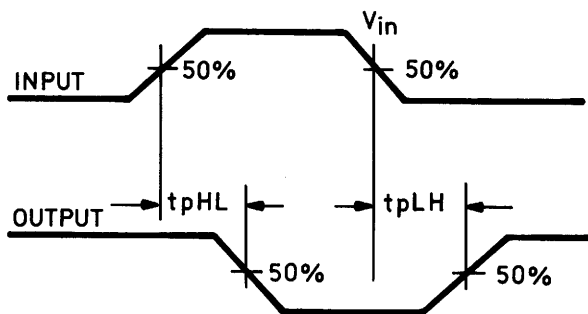

Dwg. No. A-13,272

* Complete part number includes a final letter to indicate package.
X = Digit to identify specific device. Specification shown applies to family of devices with remaining digits as shown.

FIGURE 8

**COLLECTOR CURRENT
AS A FUNCTION OF SATURATION VOLTAGE**

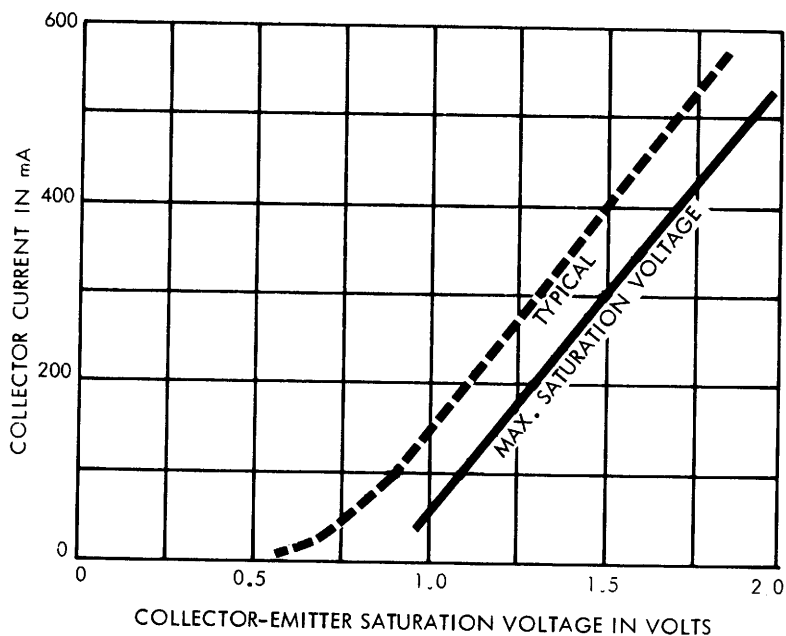

Dwg. No. A-9754C

**COLLECTOR CURRENT
AS A FUNCTION OF INPUT CURRENT**

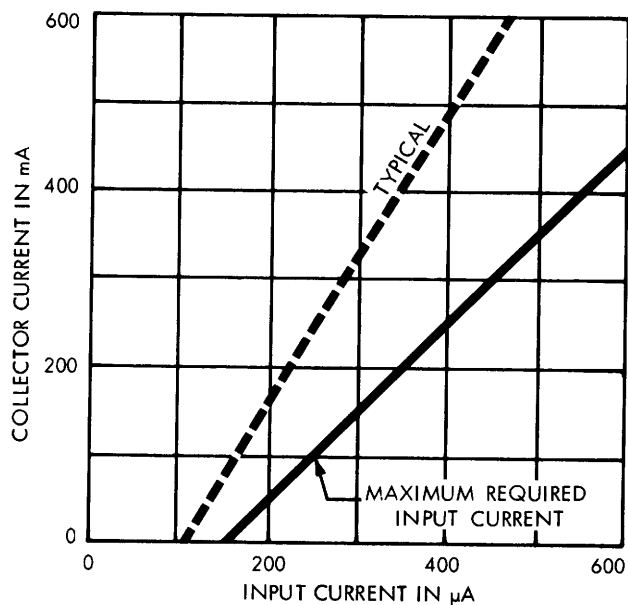

Dwg. No. A-10,872B

SERIES ULS-2800H

**PEAK COLLECTOR CURRENT
AS A FUNCTION OF DUTY CYCLE AT +50°C**

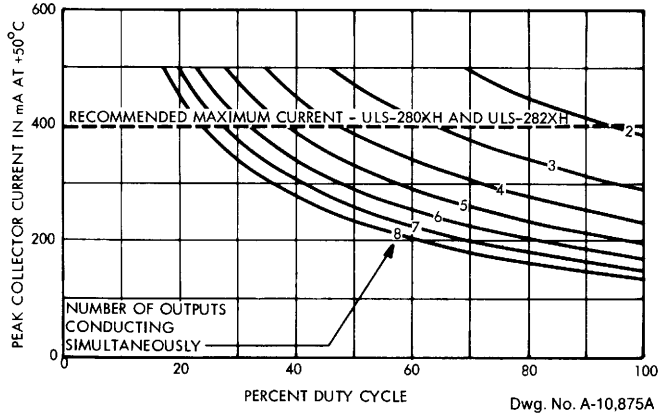

**PEAK COLLECTOR CURRENT
AS A FUNCTION OF DUTY CYCLE AT +75°C**

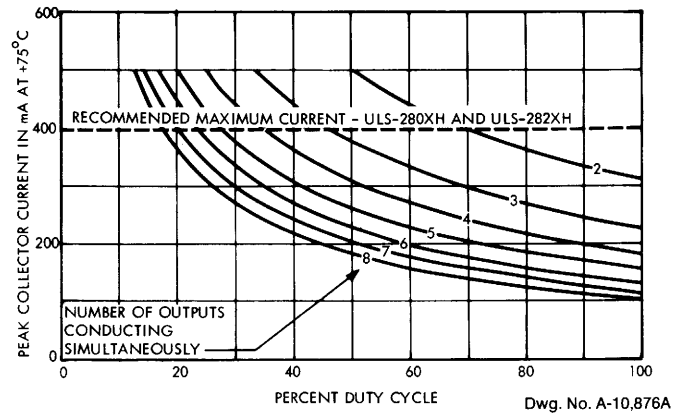

**PEAK COLLECTOR CURRENT
AS A FUNCTION OF DUTY CYCLE AT +100°C**

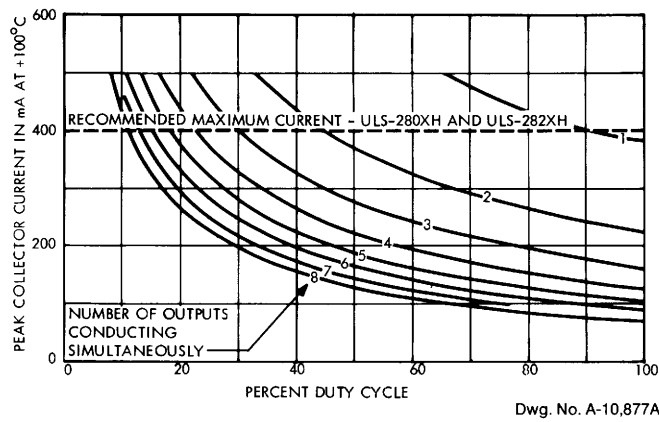

**PEAK COLLECTOR CURRENT
AS A FUNCTION OF DUTY CYCLE AT +125°C**

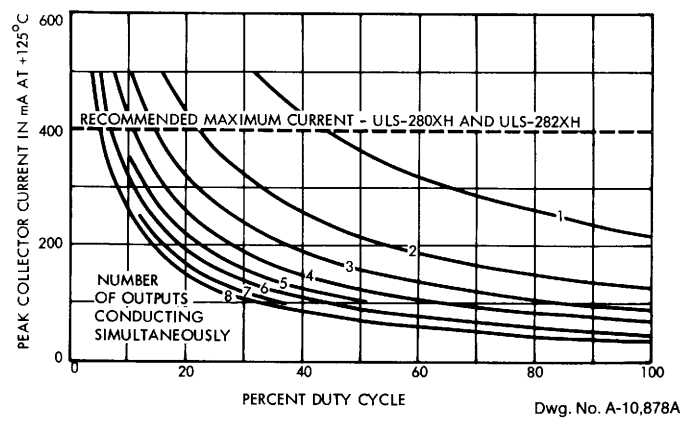

X = digit to identify specific device. Specification or limit shown applies to family of devices with remaining digits as shown.

SERIES ULS-2800R

**PEAK COLLECTOR CURRENT
AS A FUNCTION OF DUTY CYCLE AT +50°C**

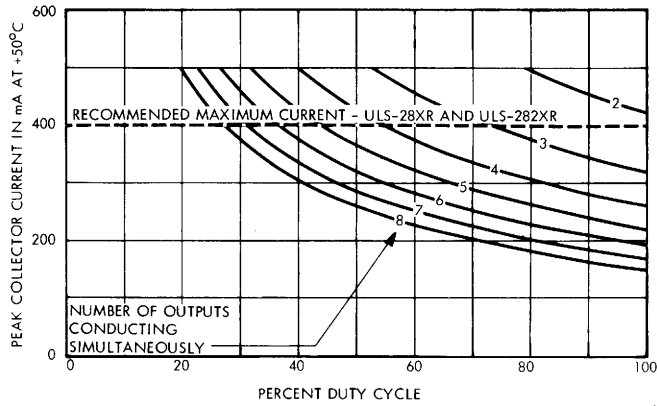

Dwg. No. A-10,870A

**PEAK COLLECTOR CURRENT
AS A FUNCTION OF DUTY CYCLE AT +75°C**

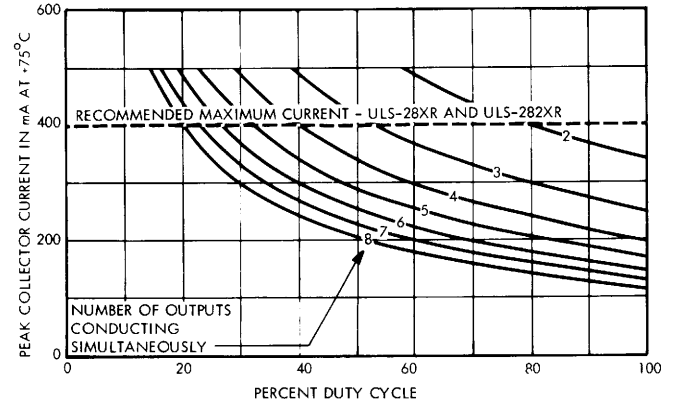

Dwg. No. A-10,871A

**PEAK COLLECTOR CURRENT
AS A FUNCTION OF DUTY CYCLE AT +100°C**

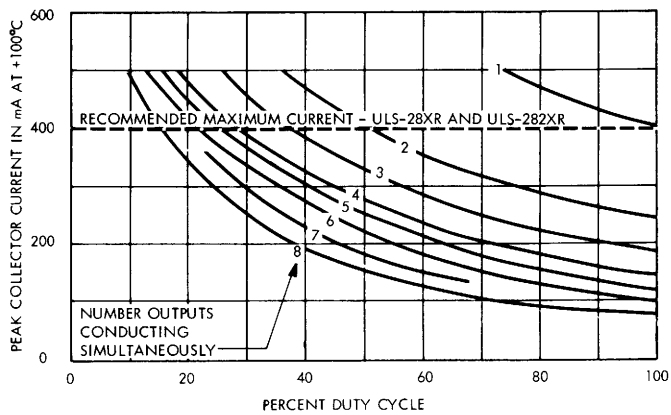

Dwg. No. A-12,466

**PEAK COLLECTOR CURRENT
AS A FUNCTION OF DUTY CYCLE AT +125°C**

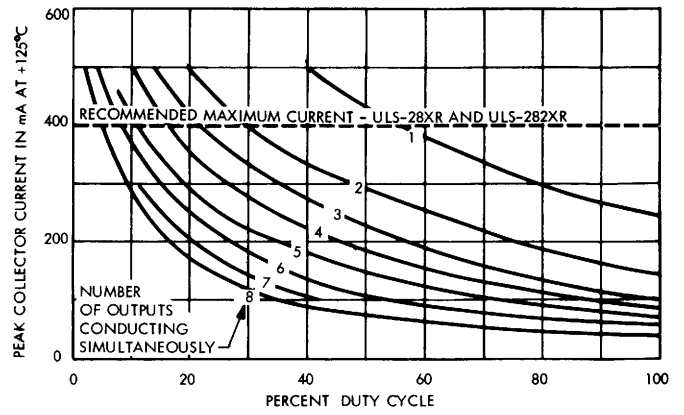

Dwg. No. A-12,467

X = digit to identify specific device. Specification or limit shown applies to family of devices with remaining digits as shown.

INPUT CURRENT AS A FUNCTION OF INPUT VOLTAGE

ULS-28X2

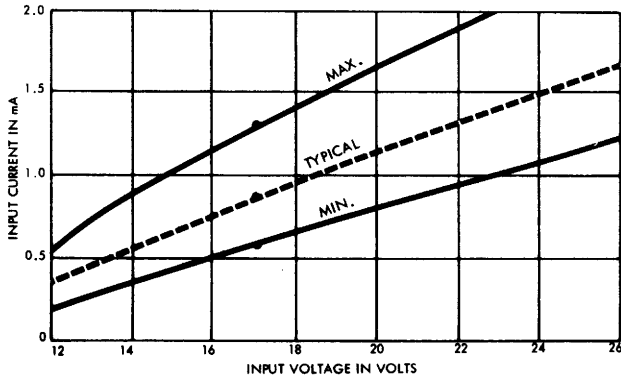

Dwg. No. A-10,225A

ULS-28X3

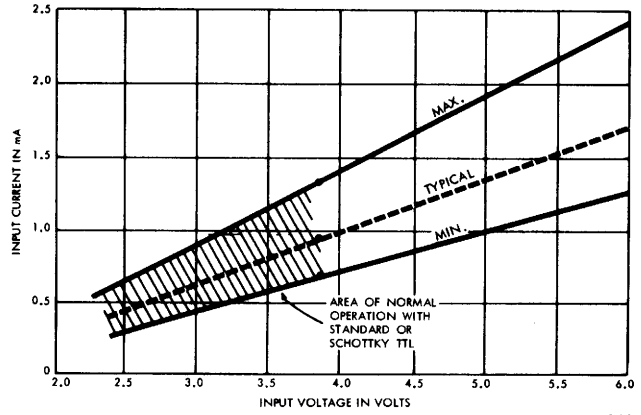

Dwg. No. A-10,224A

ULS-28X4

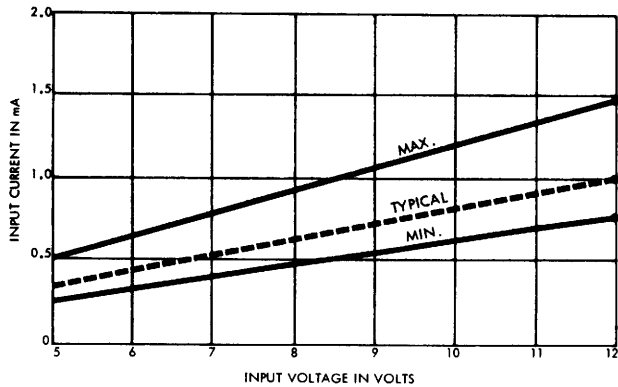

Dwg. No. A-10,226A

ULS-28X5

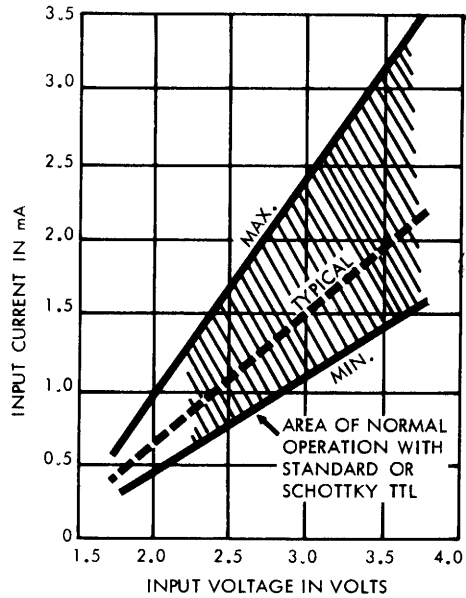

Dwg. No. A-10,874A

X = digit to identify specific device. Specification or limit shown applies to family of devices with remaining digits as shown.

HERMETIC GLASS/METAL 'H' PACKAGE

DIMENSIONS IN INCHES

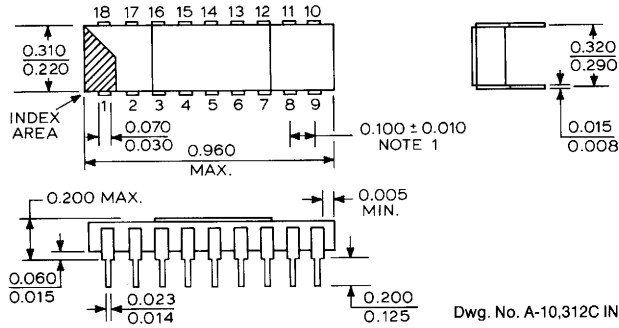

DIMENSIONS IN MILLIMETERS

Based on 1" = 25.4 mm

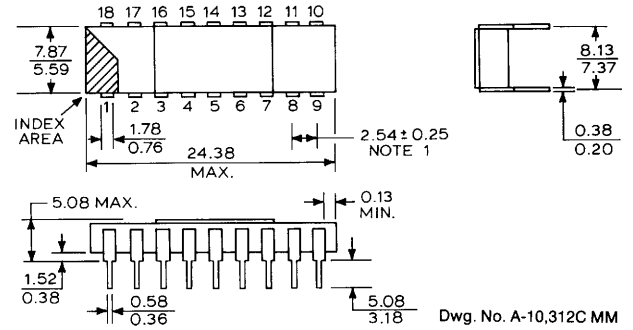

This package conforms to military specification MIL-M-38510, case outline D-6, configuration 3. Devices using this package are marked to indicate compliance to the latest issue of MIL-STD-883. For example: ULS2801H-883.

HERMETIC CERAMIC/GLASS 'R' PACKAGE

DIMENSIONS IN INCHES

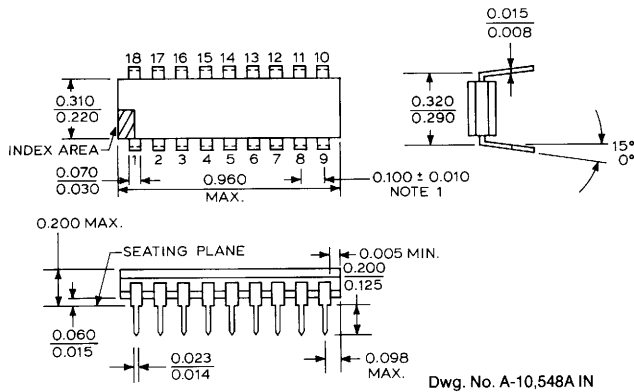

DIMENSIONS IN MILLIMETERS

Based on 1" = 25.4 mm

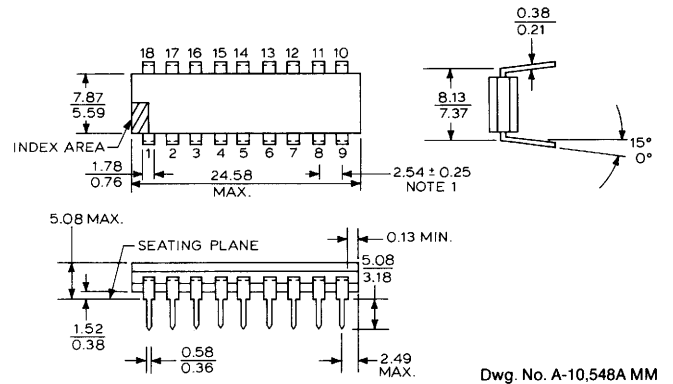

This package conforms to military specification MIL-M-38510, case outline D-6, configuration 1. Devices using this package are marked to indicate compliance to the latest issue of MIL-STD-883. For example: ULS2803R-883.

NOTES:

1. Lead spacing tolerance is non-cumulative.
2. Exact body and lead configuration at vendor's option within limits shown.
3. Lead gauge plane is 0.030 in. (0.76 mm) max. below seating plane.

