

Quad, Wide-Bandwidth SPDT Video Analog Switch

UM330 TSSOP16

General Description

The UM330 is a quad, bi-directional, single-pole/double-throw (SPDT) video analog switch operates from a single +5V supply. The device is recommended for both RGB and composite video switching applications. The video switch can be driven from a current output RAMDAC or voltage output composite video source.

The UM330 features quad 6Ω R_{ON} (TYP) SPDT switches with 500MHz bandwidth and low crosstalk. The switch offers a high-performance, low-cost solution to switch between video sources. The switch is available in Pb-free TSSOP16 package.

Applications

- Personal Video Recorders
- Terrestrial Set-Top Boxes
- Hard Disk Recorders
- DVD Players
- Game Consoles
- Digital VCRs
- Desktop Video Editors
- Audio and Video Switching

Features

- Wide Bandwidth: 500MHz(TYP)
- Low On-Resistance: 6Ω (TYP)
- Single-Supply Operation: 5V
- Fast Switching Time
- Rail-to-Rail Operation
- Typical Power Consumption($5\mu W$)
- TTL/CMOS Compatible
- Low Crosstalk: -60dB (10MHz)
- Hot Insertion Capable(It will need extra protection in power path)
- Micro Size Package: TSSOP16

Pin Configurations

Top View

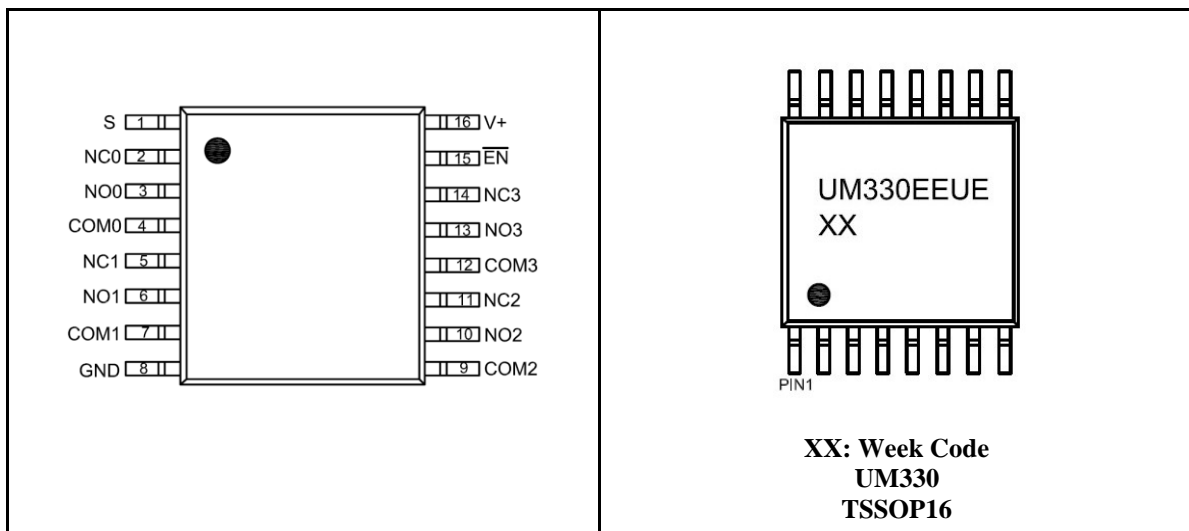

Pin Description

Name	Function
NC0,NC1,NC2,NC3,NO0,NO1,NO2,NO3	Analog video I/O
S	Select input
EN	Switch-enable input
COM0,COM1,COM2,COM3	Analog video I/O
GND	Ground
V ₊	Power supply

Block Diagram

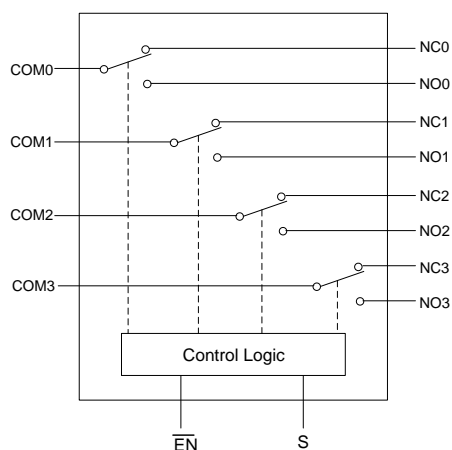

Function Table

$\overline{\text{EN}}$	S	COM0	COM1	COM2	COM3	Function
H	X	Hi-Z	Hi-Z	Hi-Z	Hi-Z	Disable
L	L	NC0	NC1	NC2	NC3	S=0
L	H	NO0	NO1	NO2	NO3	S=1

Ordering Information

Part Number	Packaging Type	Marking Code	Shipping Qty
UM330	TSSOP16	UM330EEUE	3000pcs/13 Inch Tape & Reel

Absolute Maximum Ratings

Symbol	Parameter	Limit	Unit
V ₊	Supply Voltage	- 0.3 to + 6.0	V
V _S	DC Output Voltage	- 0.3 to + 6.0	
V _{IN}	DC Input Voltage	- 0.3 to + 6.0	
I _O	Continuous Current	±200	mA
T _O	Operating Temperature Range	- 40 to +85	°C
T _J	Junction Temperature	+150	
T _{STG}	Storage Temperature Range	- 65 to +150	
T _L	Junction Lead Temperature (Soldering, 10seconds)	+300	
ESD	ESD Method 3015.7	4000	

DC Electrical Characteristics

 (Over the Operating Range, V₊=+5V±10%, T_A=-40°C to +85°C.)

Symbol	Parameter	Test Conditions	Limits (-40 to 85 °C)			Unit
			Min	Typ	Max	
V _{ANALOG}	Analog Signal Range		0		2.0	V
R _{ON}	On Resistance	V ₊ =4.5V, V _I =1.0V, R _L =75Ω, I _{ON} =13mA		6	9	Ω
		V ₊ =4.5V, V _I =2.0V, R _L =75Ω, I _{ON} =26mA		7	10	Ω
I _{CC}	Quiescent Power Supply Current	V ₊ =5.5V, V _{IN} = GND or 5V		0.1	1	μA
I _{CC(T)}	Transience Power Supply Current	V ₊ =4.3V, V _{IN} =1.8V		11	20	μA
Δ I _{CC}	Supply Current per Input @ TTL HIGH	V ₊ =5.5V, V _{IN} = 3.4V			15	μA
I _{IH}	Input High Current	V ₊ =5.5V, V _{IN} = V ₊			±1	μA
I _{IL}	Input Low Current	V ₊ =5.5V, V _{IN} = GND			±1	μA
I _O	Analog Output Leakage Current	0≤NO,NC or COM≤V ₊ , Switch OFF			±1	μA
I _{OS}	Short Circuit Current			230		mA
V _{IH}	Input High Voltage		2			V
V _{IL}	Input Low Voltage		-0.5		0.8	V
V _{IK}	Clamp Diode Voltage	V ₊ =4.5V, I _{IN} = -18mA	-0.7	-0.9		V
V _H	Input Hysteresis at Control Pins			200		mV

AC Electrical Characteristics

Symbol	Parameter	Test Conditions	Limits (-40 to 85 °C)			Unit
			Min	Typ	Max	
t_{ON}	Turn On Time	$R_L=75\Omega, C_L=20pF$		14	17	ns
t_{OFF}	Turn Off Time	$R_L=75\Omega, C_L=20pF$		4	7	ns
V_{ISO}	Off Isolation	$R_L=150\Omega, f = 10MHz$		-50		dB
V_{CT}	Crosstalk	$R_{IN}=10\Omega, R_L=150\Omega, f = 10MHz$		-60		dB
BW	-3dB Bandwidth	$R_L=150\Omega$		500		MHz
DG	Differential Gain	$R_L=150\Omega, f = 3.58MHz$		0.51		%
DP	Differential Phase	$R_L=150\Omega, f = 3.58MHz$		0.01		°
I_{CCD}	Supply Current per Input per MHz	$V_+=5.5V, NO, NC$ and COM Pins Open, $EN=GND$, Control Input Toggling 50% Duty Cycle		0.25		mA/MHz
Capacitance						
C_{IN}	Input/Enable Capacitance	$V_{IN}= 0V, f=1MHz$		5		pF
C_{OFF}	Switch Off Capacitance	$V_{IN}= 0V, f=1MHz$		5		pF
C_{ON}	Switch On Capacitance	$V_{IN}= 0V, f=1MHz$		10		pF

Switching Time Test

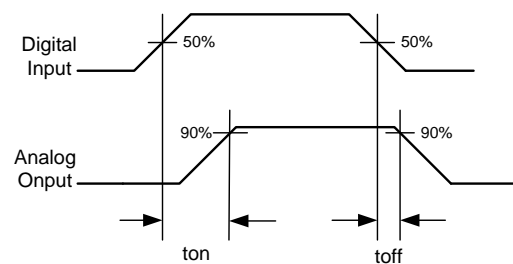
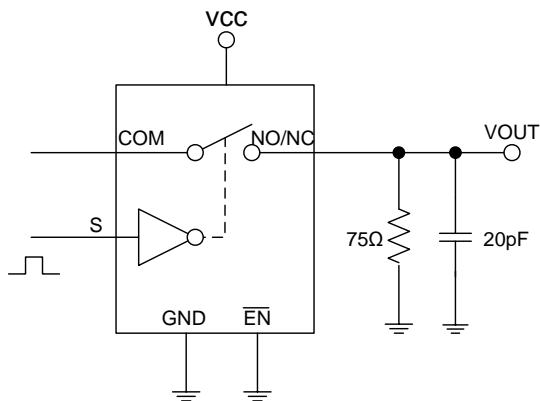

Typical Operating Characteristics

Bandwidth vs. Frequency

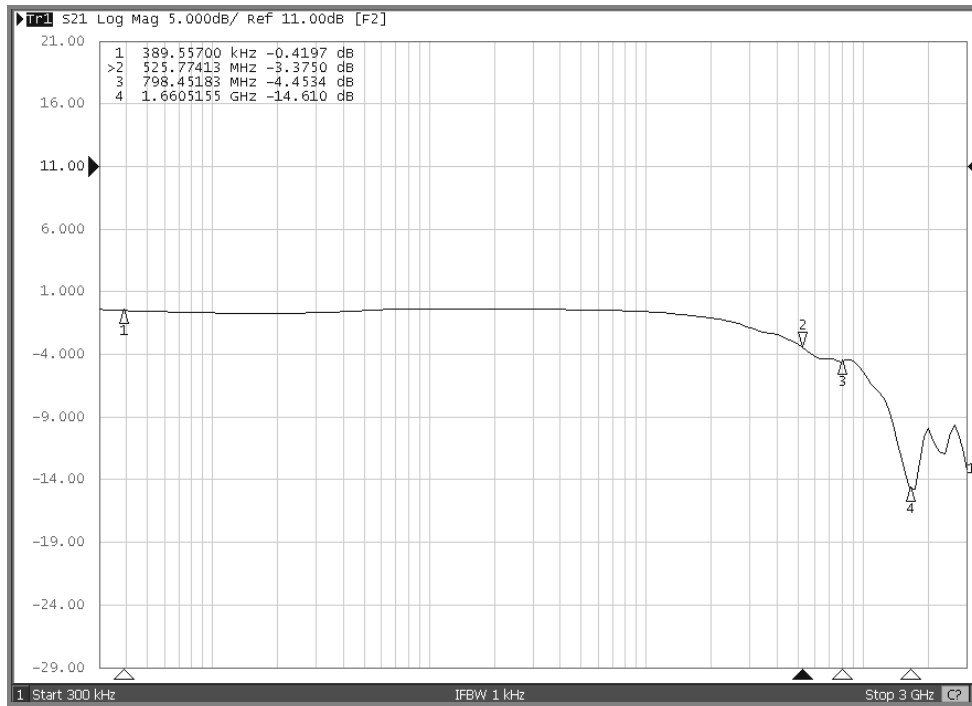

Off-Isolation vs. Frequency



Crosstalk vs. Frequency

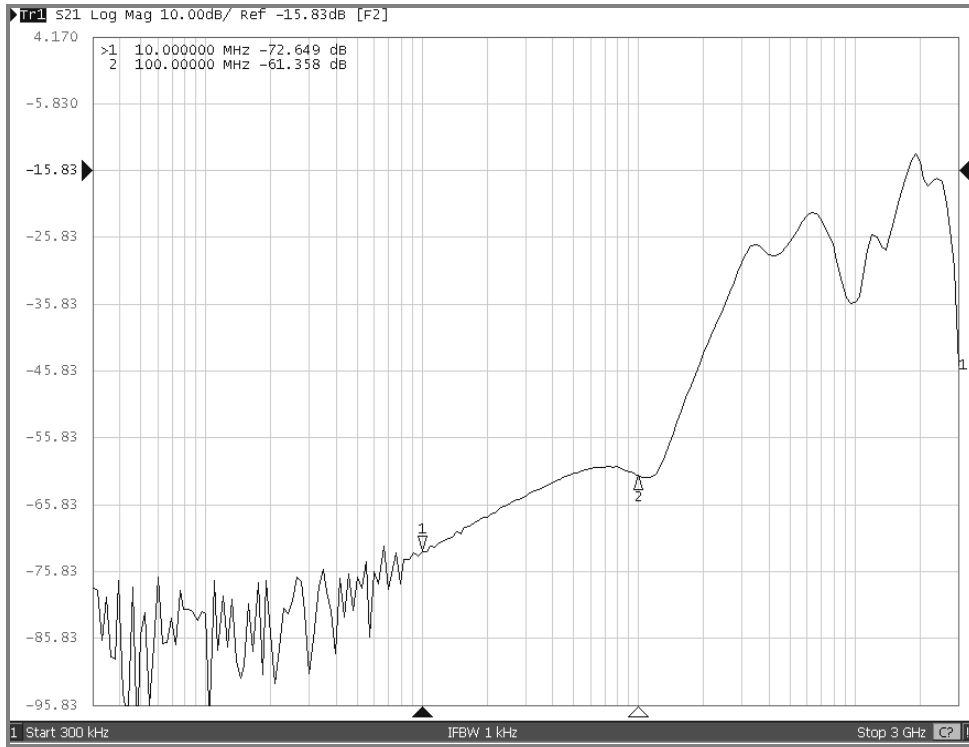

Package Information

UM330 TSSOP16

Outline Drawing

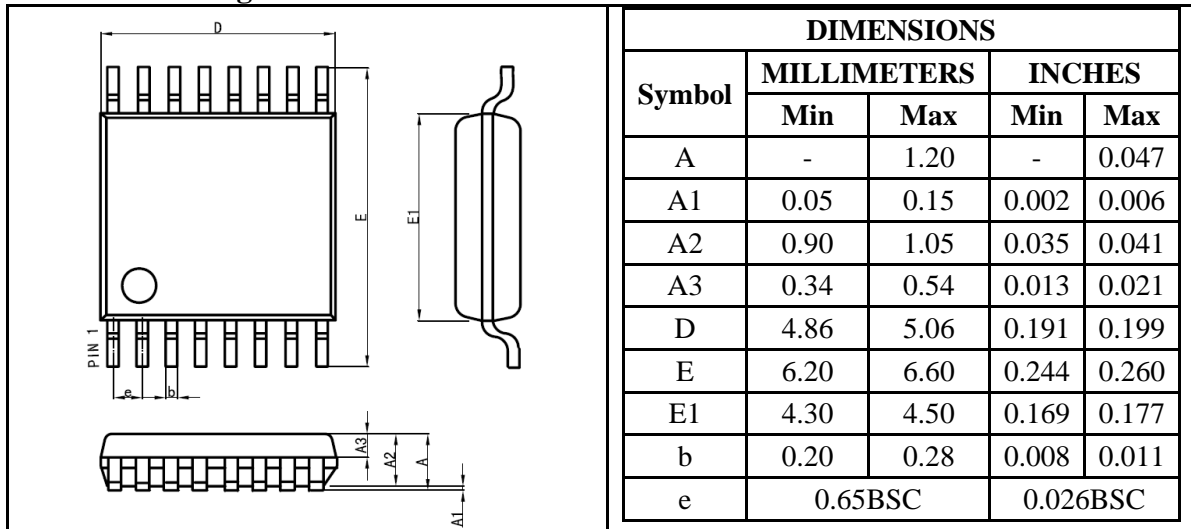

Land Pattern

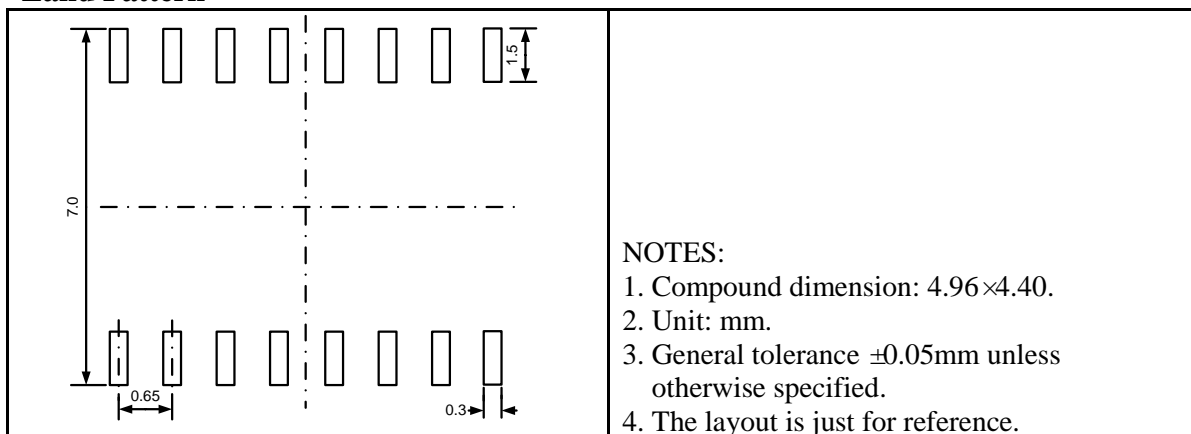

Tape and Reel Orientation

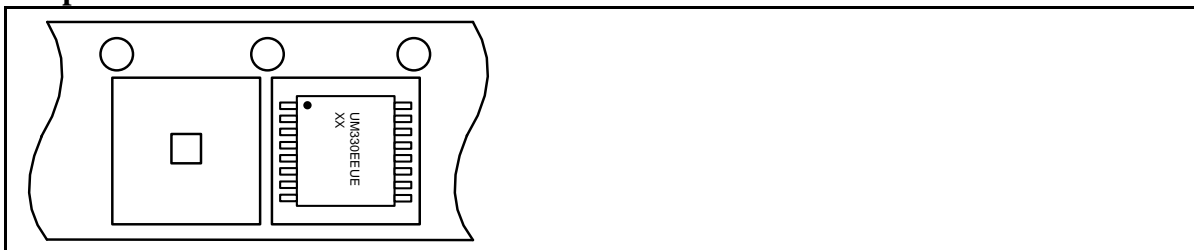

IMPORTANT NOTICE

The information in this document has been carefully reviewed and is believed to be accurate. Nonetheless, this document is subject to change without notice. Union assumes no responsibility for any inaccuracies that may be contained in this document, and makes no commitment to update or to keep current the contained information, or to notify a person or organization of any update. Union reserves the right to make changes, at any time, in order to improve reliability, function or design and to attempt to supply the best product possible.



Union Semiconductor, Inc

Add: Unit 606, No.570 Shengxia Road, Shanghai 201210

Tel: 021-51093966

Fax: 021-51026018

Website: www.union-ic.com