

***±15kV ESD-Protected, Slew-Rate-Limited, Fail-Safe,
True RS-485 Transceivers***

UM3352E SOP8/DIP8

General Description

The UM3352E series are ±15kV ESD-protected, high-speed, half-duplex transceivers for RS-485 communication that contain one driver and one receiver. The device features fail-safe circuitry, which guarantees a logic-high receiver output when the receiver inputs are open, shorted or idle. This means that the receiver output will be logic high if all transmitters on a terminated bus are disabled (high impedance). The UM3352E features reduced slew-rate driver that minimizes EMI and reduces reflections caused by improperly terminated cables, allowing error-free data transmission up to 500kbps. It also features enhanced ESD protection. All transmitter outputs and receiver inputs incorporate advanced structures allowing them to survive ESD events in excess of ±15kV Human Body Mode and IEC61000-4-2 Air Discharge Mode, ±8kV IEC61000-4-2 Contact Discharge Mode. New ESD structures protect the device whether or not it is powered up and without degrading the RS-485 common mode range of -7V to 12V. The UM3352E includes a hot swap circuit inside, which allows live cable insertion and removal. Proprietary protection circuit built on A and B ports, can dissipate high surge current up to 6A to ground.

The transceivers typically draw 450µA of supply current when unloaded, or when fully loaded with the drivers disabled. The device has a 1/8-unit-load receiver input impedance that allows up to 256 transceivers on the bus and are intended for half-duplex communications.

Applications

- RS-485 Transceivers
- Intelligent Meters and Sensors
- Industrial Control
- Lighting Systems
- Security Systems
- HVAC Application

Features

- ESD Protection for RS-485 I/O Pins
±15kV—Human Body Mode
±15kV—IEC61000-4-2, Air Discharge Mode
±8kV—IEC61000-4-2, Contact Discharge Mode
- True Fail-Safe Receiver
- Enhanced Slew-Rate Limiting Facilitates Error-Free Data Transmission
- 2µA Low-Current Shutdown Mode
- -7V to +12V Common-Mode Input Voltage Range
- Allows up to 256 Transceivers on the Bus
- Thermal Shutdown
- Current-Limiting for Driver Overload Protection
- Hot Swap Capability

Ordering Information

Part Number	Operating Temperature	Mark Code	Package Type	Shipping Qty
UM3352EESA	-40 °C to +85 °C	UM3352EESA	SOP8	2500pcs/13 Inch Tape & Reel
UM3352EEPA	-40 °C to +85 °C	UM3352EEPA	DIP8	50pcs/Tube

Device Electrical Characteristic Summary

Part Number	Guaranteed Data Rate (Mbps)	Low-Power Shutdown	Slew-Rate Limited	Driver/Receiver Enable	Shutdown Current (µA)	Transceivers On Bus	±15kV ESD Protection
UM3352E	0.5	Yes	Yes	Yes	2	256	Yes

Absolute Maximum Ratings

Symbol	Parameter	Value	Unit
V_{CC}	Supply Voltage	+7	V
	Control Input Voltage (\overline{RE} , DE)	-0.3V to ($V_{CC} + 0.3V$)	V
	Driver Input Voltage (DI)	-0.3V to ($V_{CC} + 0.3V$)	V
	Driver Output Voltage (A, B)	-7.5 to +12.5	V
	Receiver Input Voltage (A, B)	-7.5 to +12.5	V
	Receiver Output Voltage (RO)	-0.3V to ($V_{CC} + 0.3V$)	V
T_A	Ambient Temperature	-40 to +85	°C
T_{STG}	Storage Temperature Range	-65 to +160	°C
T_L	Lead Temperature for Soldering 10 seconds	+300	°C

DC Electrical Characteristics

($V_{CC}=+5V \pm 5\%$, $T_A=-40\text{ °C}$ to $+85\text{ °C}$, unless otherwise noted. Typical values are at $V_{CC}=+5V$ and $T_A=+25\text{ °C}$.) (Note 1)

Parameter	Symbol	Test Conditions	Min	Typ	Max	Unit
SUPPLY CURRENT						
Supply Current	I_{CC}	No Load, DI=GND or V_{CC}	$\overline{RE}=V_{CC}$, DE=0V or V_{CC}		0.45	mA
			DE=0V, $\overline{RE}=0V$		0.45	
Supply Current in Shutdown Mode	I_{SHDN}	DE = GND, $\overline{RE} = V_{CC}$		2		μA
LOGIC						
Input High Voltage	V_{IH}	DE, DI, \overline{RE}	2.0			V
Input Low Voltage	V_{IL}	DE, DI, \overline{RE}			0.8	V
Input Hysteresis	V_{HYS}	DE, DI, \overline{RE}	100			mV
Input Leakage Current	I_{LEAK}	DE, DI, \overline{RE}			± 2	μA
DRIVER						
Differential Driver Output	V_{OD1}	No Load, Figure 2			5	V
Differential Driver Output	V_{OD2}	Figure 2, $R_{LOAD}=50\Omega$	1.5			V
Change-in-Magnitude of Differential Output Voltage	ΔV_{OD}	Figure 2, $R_{LOAD}=50\Omega$ (Note 2)			0.2	V
Driver Common-Mode Output Voltage	V_{OC}	Figure 2, $R_{LOAD}=50\Omega$			3.0	V
Change-in-Magnitude of Common-Mode Voltage	ΔV_{OC}	Figure 2, $R_{LOAD}=50\Omega$ (Note 2)			0.2	V
Driver Short-Circuit Output Current (Note 3)	I_{OSD}	$V_{OUT}=-7V$		-250		mA
		$V_{OUT}=12V$		250		

DC Electrical Characteristics (Continued)

($V_{CC}=+5V \pm 5\%$, $T_A=-40\text{ }^\circ\text{C}$ to $+85\text{ }^\circ\text{C}$, unless otherwise noted. Typical values are at $V_{CC}=+5V$ and $T_A=+25\text{ }^\circ\text{C}$.) (Note 1)

Parameter	Symbol	Test Conditions	Min	Typ	Max	Unit
RECEIVER						
Receiver Differential Threshold Voltage	V_{TH}	$-7V \leq V_{CM} \leq 12V$	-200		-50	mV
Receiver Input Hysteresis	ΔV_{TH}	$V_{CM}=0V$		25		mV
Receiver Input Resistance	R_{IN}	$-7V \leq V_{CM} \leq 12V$	96			k Ω
Input Current (A and B)	I_{IN2}	DE=GND, V _{CC} =GND or 5V	V _{IN} =12V		1.0	mA
			V _{IN} =-7V		-0.8	
Receiver Output High Voltage	V_{OH}	$I_O=-1.5mA$, $V_{ID}=+200mV$	$V_{CC}-1.5$			V
Receiver Output Low Voltage	V_{OL}	$I_O=2.5mA$, $V_{ID}=-200mV$			0.4	V
Three-State Output Current at Receiver	I_{OZR}	$V_{CC}=5V$, $0V \leq V_O \leq V_{CC}$			± 1	μA
Receiver Output Short Circuit Current	I_{OSR}	$0V \leq V_{RO} \leq V_{CC}$	± 8		± 60	mA
ESD Protection						
ESD Protection for A, B		Human Body Mode		± 15		kV
		IEC61000-4-2 Air Discharge Mode		± 15		
		IEC61000-4-2 Contact Discharge Mode		± 8		

Note 1: All currents into the device are positive; all currents out of the device are negative. All voltages are referred to device ground unless otherwise noted.

Note 2: ΔV_{OD} and ΔV_{OC} are the changes in V_{OD} and V_{OC} , respectively, when the DI input changes state.

Note 3: Maximum current level applies to peak current just prior to fold back current limiting; minimum current level applies during current limiting.

Switching Characteristics

($V_{CC}=+5V \pm 5\%$, $T_A=-40\text{ }^\circ\text{C}$ to $+85\text{ }^\circ\text{C}$, unless otherwise noted. Typical values are at $V_{CC}=+5V$ and $T_A=+25\text{ }^\circ\text{C}$.)

Parameter	Symbol	Test Conditions	Min	Typ	Max	Unit
Maximum Data Rate	f_{MAX}			500		kbps
Driver Input-to-Output	t_{DPLH}	Figures 3 and 7, $R_{DIFF}=54\Omega$, $C_{L1}=C_{L2}=100\text{pF}$		50	1000	ns
	t_{DPHL}			50	1000	
Driver Output Skew $t_{DPLH} - t_{DPHL}$	t_{DSKEW}	Figures 3 and 7, $R_{DIFF}=54\Omega$, $C_{L1}=C_{L2}=100\text{pF}$		15	100	ns
Driver Rise or Fall Time	t_{DR}, t_{DF}	Figures 3 and 7, $R_{DIFF}=54\Omega$, $C_{L1}=C_{L2}=100\text{pF}$		100	750	ns
Driver Enable to Output High	t_{DZH}	Figures 4 and 8, $C_L=100\text{pF}$, S2 Closed		30	2500	ns
Driver Enable to Output Low	t_{DZL}	Figures 4 and 8, $C_L=100\text{pF}$, S1 Closed		30	2500	ns
Driver Disable Time from Low	t_{DLZ}	Figures 4 and 8, $C_L=15\text{pF}$, S1 Closed		60	200	ns
Driver Disable Time from High	t_{DHZ}	Figures 4 and 8, $C_L=15\text{pF}$, S2 Closed		100	200	ns
Receiver Input to Output	t_{RPLH}, t_{RPHL}	$ V_{ID} \geq 2.0V$, Rise and Fall Time of $V_{ID} \leq 15\text{ns}$		75	200	ns
Differential Receiver Skew $t_{RPLH} - t_{RPHL}$	t_{RSKD}	Figures 6 and 9, $ V_{ID} \geq 2.0V$, Rise and Fall Time of $V_{ID} \leq 15\text{ns}$		0	30	ns
Receiver Enable to Output Low	t_{RZL}	Figures 5 and 10, $C_L=100\text{pF}$, S1 Closed		20	50	ns
Receiver Enable to Output High	t_{RZH}	Figures 5 and 10, $C_L=100\text{pF}$, S2 Closed		20	50	ns
Receiver Disable Time from Low	t_{RLZ}	Figures 5 and 10, $C_L=100\text{pF}$, S1 Closed		20	50	ns
Receiver Disable Time from High	t_{RHZ}	Figures 5 and 10, $C_L=100\text{pF}$, S2 Closed		20	50	ns
Time to Shutdown	t_{SHDN}	(Note 4)		200	600	ns
Driver Enable from Shutdown to Output High	$t_{DZH(SHDN)}$	Figures 4 and 8, $C_L=15\text{pF}$, S2 Closed		700	4500	ns
Driver Enable from Shutdown to Output Low	$t_{DZL(SHDN)}$	Figures 4 and 8, $C_L=15\text{pF}$, S1 Closed		700	4500	ns
Receiver Enable from Shutdown to Output High	$t_{RZH(SHDN)}$	Figures 5 and 10, $C_L=100\text{pF}$, S2 Closed		700	3500	ns
Receiver Enable from Shutdown to Output Low	$t_{RZL(SHDN)}$	Figures 5 and 10, $C_L=100\text{pF}$, S1 Closed		700	3500	ns

Note 4: The device is put into shutdown by bringing \overline{RE} high and DE low. If the enable inputs are in this state for less than 50ns, the device is guaranteed not to enter shutdown. If the enable inputs are in this state for at least 600ns, the device is guaranteed to have entered shutdown.

Typical Operating Characteristics

($V_{CC}=+5.0V$, $T_A=+25^{\circ}C$, unless otherwise noted.)

Supply Current vs. Temperature

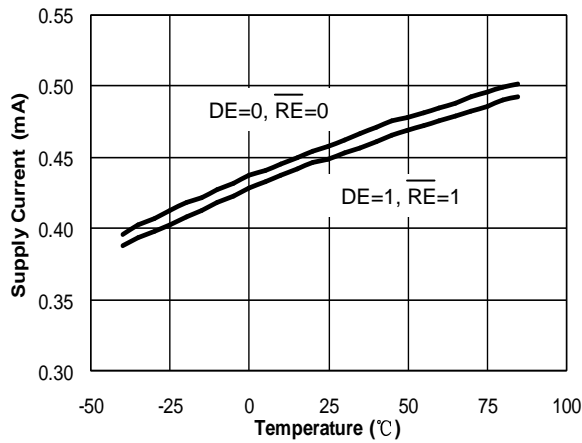

Driver Differential Output Voltage vs. Temperature
 $R_{LOAD}=54\Omega$

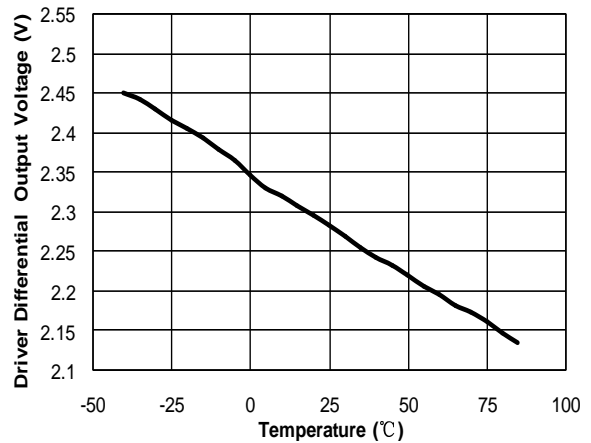

Receiver Output High Voltage vs. Temperature

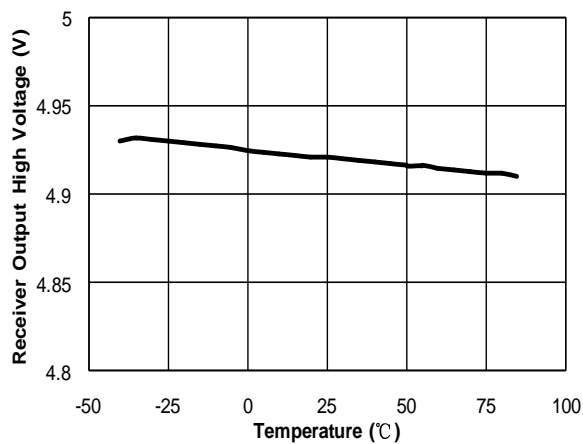

Receiver Output Low Voltage vs. Temperature

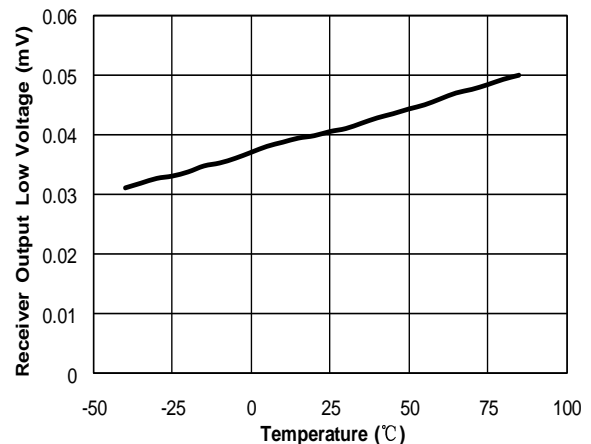

A B Short-Circuit Current vs. Temperature

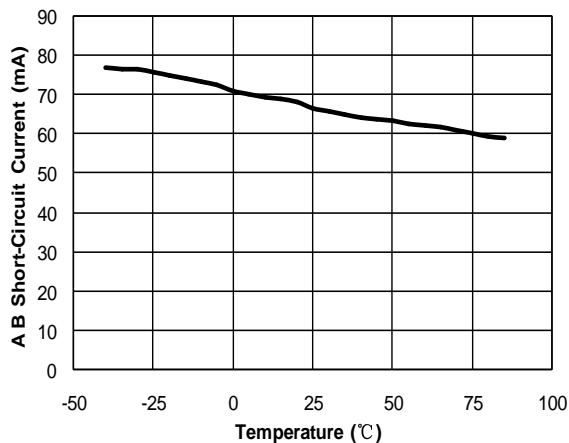

A B Pin I-V Snap Back Characteristic

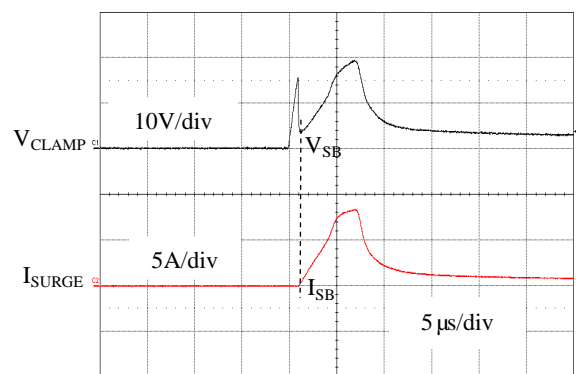

Typical Operating Characteristics (Continued)

 ($V_{CC}=+5.0V$, $T_A=+25^{\circ}C$, unless otherwise noted.)

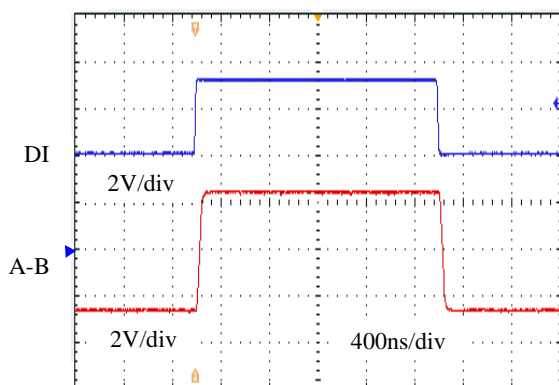
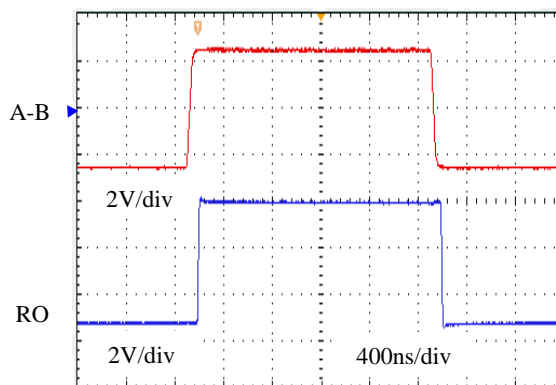
Transmitter Propagation Delay
 $R_L=54\Omega$, $C_L=100pF$

Receiver Propagation Delay
 $R_L=54\Omega$, $C_L=100pF$

Pin Description

Pin Number	Symbol	Function
1	RO	Receiver Output. If $(A-B) \geq -50mV$, RO will be high; if $(A-B) \leq -200mV$, RO will be low.
2	\overline{RE}	Receiver Output Enable. Drive RE low to enable Receiver, RO is high impedance when RE is high. Drive RE high and DE low to enter low-power shutdown mode.
3	DE	Driver Enable. Drive DE high to enable drivers. The outputs are high impedance when DE is low. Drive RE high and DE low to enter low-power shutdown mode.
4	DI	Driver Input. A low on DI forces output A low and output B high. Similarly, a high on DI forces output A high and output B low.
5	GND	Ground
6	A	Non-Inverting Receiver Input and Non-Inverting Driver Output
7	B	Inverting Receiver Input and Inverting Driver Output
8	V_{CC}	Power Supply for RS-485 Transceiver

RS-485 Communication Function Table
Table1. Transmitting

INPUTS			OUTPUTS	
RE	DE	DI	B	A
X	1	1	0	1
X	1	0	1	0
0	0	X	High-Z	High-Z
1	0	X	Shutdown	

X=Don't care; High-Z=High impedance

Table2. Receiving

INPUTS			OUTPUTS
RE	DE	A-B	RO
0	X	$\geq -50mV$	1
0	X	$\leq -200mV$	0
0	X	Open/Shorted	1
1	1	X	High-Z
1	0	X	Shutdown

X=Don't care; High-Z=High impedance

Typical Operating Circuit

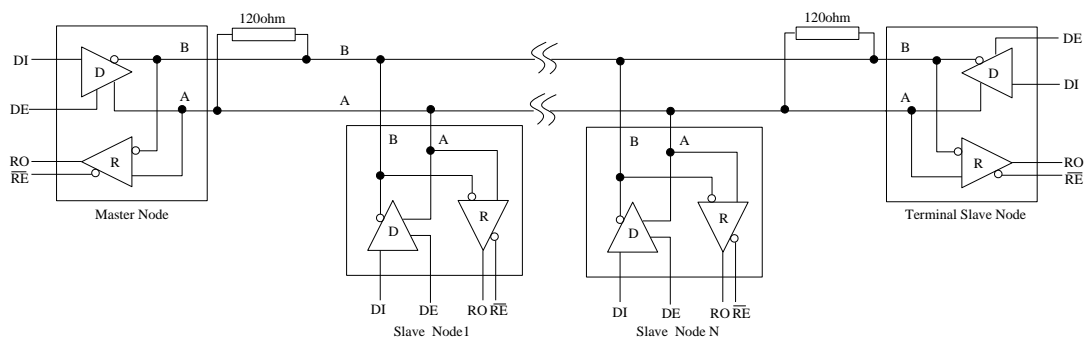

Figure 1. Typical Half-Duplex RS-485 Network

Test Circuit

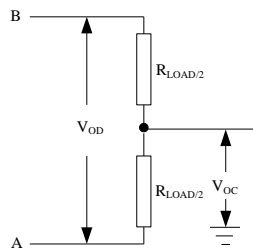

Figure 2. Driver DC Test Load

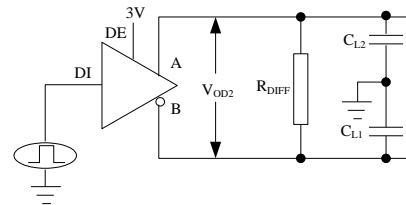

Figure 3. Driver Timing Test Circuit

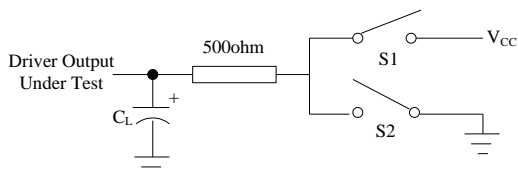

Figure 4. Driver Enable/Disable Timing Test Load

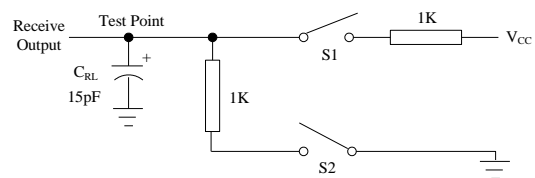

Figure 5. Receiver Enable/Disable Timing Test Load

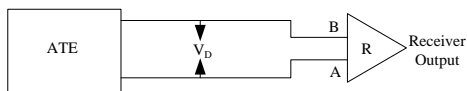
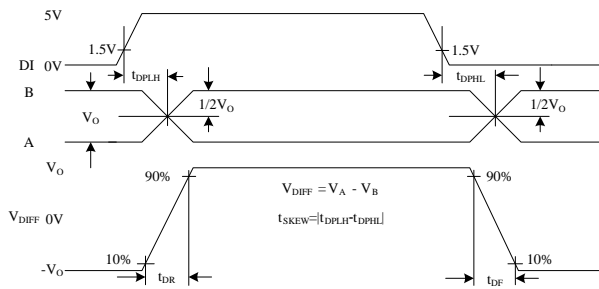
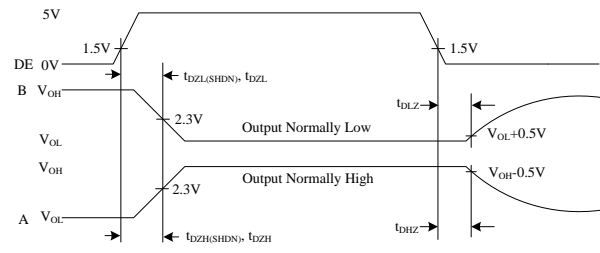
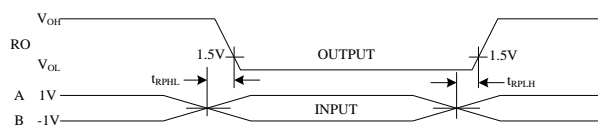
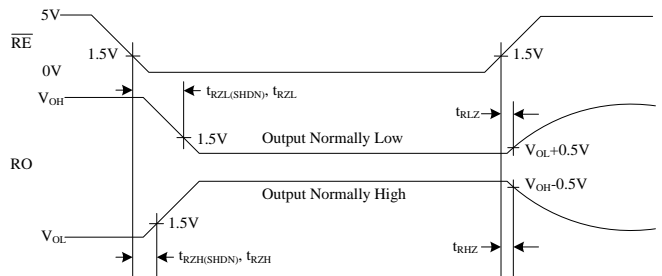

Figure 6. Receiver Propagation Delay Test Circuit

Figure 7. Driver Propagation Delays

Figure 8. Driver Enable and Disable Times

Figure 9. Receiver Propagation Delays

Figure 10. Receiver Enable and Disable Times

Detail Description

The UM3352E high-speed transceivers for RS-485 communication contain one driver and one receiver. The device features fail-safe circuitry, which guarantees a logic-high receiver output when the receiver input is open or shorted, or when it is connected to a terminated transmission line with all drivers disabled. The UM3352E features reduced slew-rate driver that minimizes EMI and reduces reflections caused by improperly terminated cables, allowing error-free data transmission up to 500kbps. It operates from a single +5V supply. Drivers are output short-circuit current limited. Thermal shutdown circuitry protects drivers against excessive power dissipation. When activated, the thermal shutdown circuitry places the driver outputs into a high impedance state.

Fail-Safe

The UM3352E guarantees a logic-high receiver output when the receiver inputs are shorted or open, or when they are connected to a terminated transmission line with all drivers disabled. This is done by setting the receiver threshold between -50mV and -200mV. If the differential receiver input voltage (A-B) is greater than or equal to -50mV, RO is logic high. If A-B is less than or equal to -200mV, RO is logic low. In the case of a terminated bus with all transmitters disabled, the receiver's differential input voltage is pulled to 0V by the termination. With the receiver thresholds of the UM3352E, this results in a logic high with a 50mV minimum noise margin. Unlike previous fail-safe devices, the -50mV to -200mV threshold complies with the $\pm 200\text{mV}$ EIA/TIA-485 standard.

Applications Information

256 Transceivers on the Bus

The standard RS-485 receiver input impedance is 12k Ω (one unit load), and the standard driver can drive up to 32 unit loads. The Union family of transceivers have a 1/8 unit load receiver input impedance (96k Ω), allowing up to 256 transceivers to be connected in parallel on one communication line. Any combination of these devices, as well as other RS-485 transceivers with a total of 32 unit loads or fewer, can be connected to the line.

Reduced EMI and Reflections

The UM3352E is slew-rate limited, minimizing EMI and reducing reflections caused by improperly terminated cables. In general, a transmitter's rise time relates directly to the length of an unterminated stub, which can be driven with only minor waveform reflections. The following equation expresses this relationship conservatively:

$$\text{Length} = t_{\text{RISE}} / (10 \times 1.5 \text{ ns/ft})$$

Where t_{RISE} is the transmitter's rise time.

A system can work well with longer unterminated stubs, even with severe reflections, if the waveform settles out before the receiver's UART samples them.

Low-Power Shutdown Mode

Low-power shutdown mode is initiated by bringing both $\overline{\text{RE}}$ high and DE low. In shutdown, the device typically draws only 2 μA of supply current. $\overline{\text{RE}}$ and DE may be driven simultaneously; the parts are guaranteed not to enter shutdown if $\overline{\text{RE}}$ is high and DE is low for less than 50ns. If the inputs are in this state for at least 600ns, the parts are guaranteed to enter shutdown. Enable times t_{ZH} and t_{ZL} in the Switching Characteristics tables assume the part was not in a low-power shutdown state. Enable times $t_{\text{ZH(SHDN)}}$ and $t_{\text{ZL(SHDN)}}$ assume the parts were shut down. It takes drivers and receivers longer to become enabled from low-power shutdown mode ($t_{\text{ZH(SHDN)}}$, $t_{\text{ZL(SHDN)}}$) than from driver/receiver-disable mode (t_{ZH} , t_{ZL}).

Driver Output Protection

Two mechanisms prevent excessive output current and power dissipation caused by faults or by bus contention. The first, a foldback current limit on the output stage, provides immediate protection against short circuits over the whole common-mode voltage range. The second, a thermal shutdown circuit, forces the driver outputs into a high-impedance state if the die temperature becomes excessive.

Line Length vs. Data Rate

The RS-485/RS-422 standard covers line lengths up to 4000 feet. For line lengths greater than 4000 feet, repeater is required.

ESD Protection

All pins on these devices include class 2 (>2kV) Human Body Model (HBM) ESD protection structures, but the RS-485 pins (driver outputs and receiver inputs) incorporate advanced structures allowing them to survive ESD events in excess of $\pm 15\text{kV}$ HBM, $\pm 15\text{kV}$ IEC61000-4-2 Air Discharge Mode and $\pm 8\text{kV}$ IEC61000-4-2 Contact Discharge Mode. The RS-485 pins are particularly vulnerable to ESD strikes because they typically connect to an exposed port on the exterior of the finished product. Simply touching the port pins, or connecting a cable, can cause an ESD event that might destroy unprotected ICs.

These new ESD structures protect the device whether or not it is powered up, and without degrading the RS-485 common mode range of -7V to +12V. This built-in ESD protection cuts the need for board level protection structures (e.g., transient suppression diodes), and the associated, undesirable capacitive load they present.

IEC61000-4-2 Testing

The IEC61000 test method applies to finished equipments, rather than to an individual IC. Therefore, the pins most likely to suffer an ESD event are those that are exposed to the outside world (the RS-485 pins in this case), and the IC is tested in its typical application configuration (power applied) rather than testing each pin-to-pin combination. The IEC61000 standard's lower current limiting resistor coupled with the larger charge storage capacitor yields a test that is much more severe than the HBM test.

Air-Gap Discharge Test Method

For this test method, a charged probe tip moves toward the IC pin until the voltage arcs to it. The current waveform delivered to the IC pin depends on approach speed, humidity, temperature, etc., so it is difficult to obtain repeatable results. The UM3352E RS-485 pins withstand $\pm 15\text{kV}$ air-gap discharges.

Contact Discharge Test Method

During the contact discharge test, the probe contacts the tested pin before the probe tip is energized, thereby eliminating the variables associated with the air-gap discharge. The result is a more repeatable and predictable test, but equipment limits prevent testing devices at voltages higher than $\pm 8\text{kV}$. The RS-485 pins of all the UM3352E versions survive $\pm 8\text{kV}$ contact discharges.

Typical Applications

The UM3352E transceivers are designed for bidirectional data communications on multipoint bus transmission lines. To minimize reflections, the line should be terminated at both ends in its characteristic impedance, and stub lengths of the main line should be kept as short as possible.

Package Information

SOP8

Outline Drawing

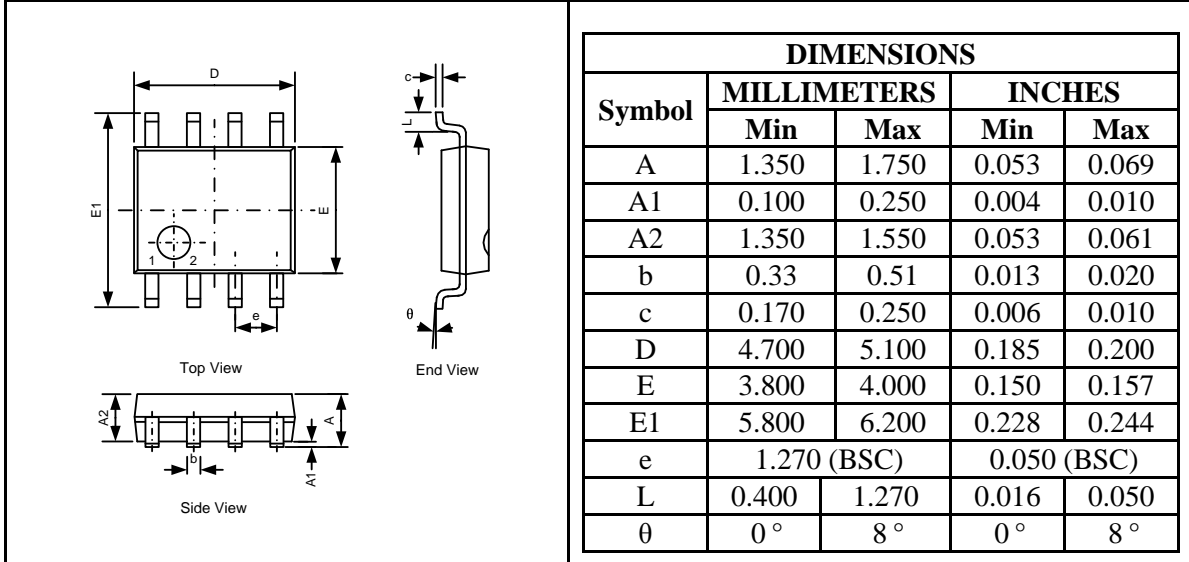

Land Pattern

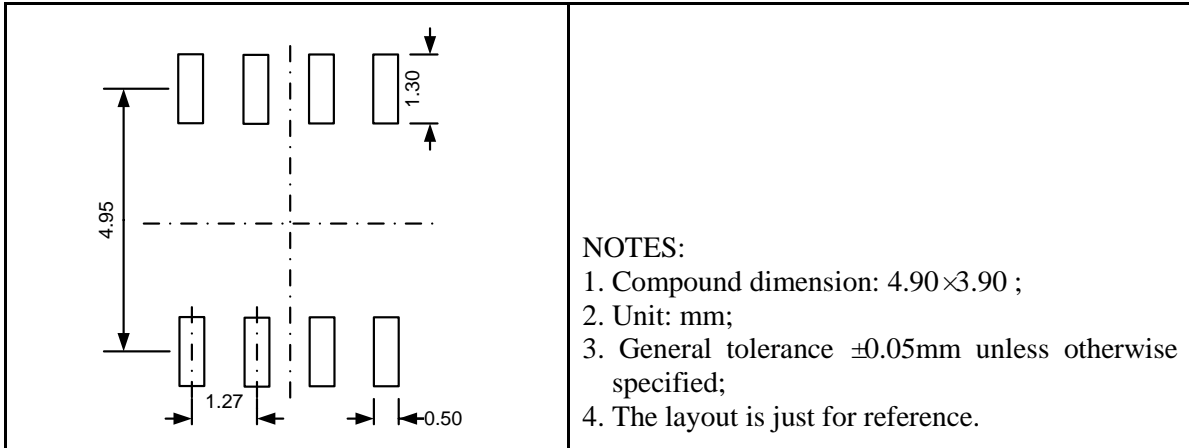

Tape and Reel Orientation



DIP8

Outline Drawing

Symbol	DIMENSIONS			
	MILLIMETERS		INCHES	
	Min	Max	Min	Max
A	-	5.08	-	0.200
A1	0.38	-	0.015	-
A2	3.18	4.45	0.125	0.175
A3	1.40	2.03	0.055	0.080
b	0.41	0.56	0.016	0.022
b1	1.14	1.65	0.045	0.065
C	0.20	0.30	0.008	0.012
D	8.84	9.91	0.348	0.390
D1	0.13	2.03	0.005	0.080
E	7.62	8.26	0.300	0.325
E1	6.10	7.87	0.240	0.310
e	2.54	-	0.100	-
eA	7.62	-	0.300	-
eB	-	10.16	-	0.400
L	2.92	3.81	0.115	0.150

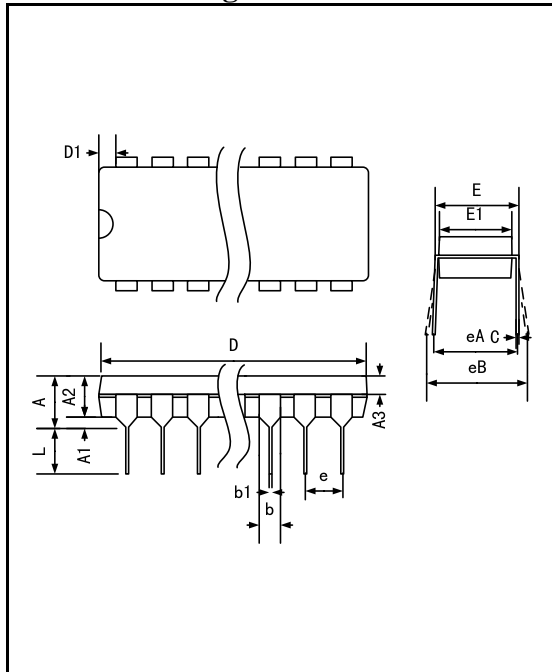

GREEN COMPLIANCE

Union Semiconductor is committed to environmental excellence in all aspects of its operations including meeting or exceeding regulatory requirements with respect to the use of hazardous substances. Numerous successful programs have been implemented to reduce the use of hazardous substances and/or emissions.

All Union components are compliant with the RoHS directive, which helps to support customers in their compliance with environmental directives. For more green compliance information, please visit:

http://www.union-ic.com/index.aspx?cat_code=RoHSDeclaration

IMPORTANT NOTICE

The information in this document has been carefully reviewed and is believed to be accurate. Nonetheless, this document is subject to change without notice. Union assumes no responsibility for any inaccuracies that may be contained in this document, and makes no commitment to update or to keep current the contained information, or to notify a person or organization of any update. Union reserves the right to make changes, at any time, in order to improve reliability, function or design and to attempt to supply the best product possible.



Union Semiconductor, Inc

Add: Unit 606, No. 570 Shengxia Road, Shanghai 201210

Tel: 021-51093966

Fax: 021-51026018

Website: www.union-ic.com