



## Single Output UMP Models

### High-Efficiency, Smaller-Package 25-40 Watt, DC/DC Converters

#### Features

- Higher operating temperatures
- Fully potted
- Designed to meet UL1950 and EN60950 (basic insulation)
-  mark available (75V-input models)
- Fully isolated, 1500Vdc guaranteed
- 25/30/35/40W output power
- Standard pinout! Smaller size!
- New 2" x 3" package fits 3" x 3" footprint
- 5V, 12V or 15V outputs
- Four input voltage ranges:  
10-36V, 18-36V  
18-75V, 36-75V
- High efficiency (to 85%)
- Input under and overvoltage lockout
- V<sub>OUT</sub> trim and on/off control
- Modifications and customs for OEM's

DATEL's new UMP Models are fully potted, 25-40 Watt DC/DC converters designed to meet UL1950 and EN60950 safety standards. The combination of the UMP's higher efficiencies and thermally conductive potting compound enables these devices to achieve higher operating temperatures without derating. The 2" x 3" UMP "footprint" conforms with the standard pinout and pin geometries of most 3" x 3" devices (a 33% space savings) while delivering as much as 60% more power (40W vs. 25W).

Applicable to a wide range of telecom, computer and other OEM applications, UMP Model DC/DC's operate from four input voltage ranges (10-36V for "Q12" models, 18-36V for "D24" models, 18-75V for "Q48" models, and 36-75V for "D48" models). Available output voltages are 5, 12 and 15 Volts.

For reliability and affordability, DATEL exploits contemporary, high-speed, automatic assembly to construct the UMP's traditional, field-proven, SMT-on-pcb designs. Devices employ corrosion-resistant metal cases with plastic headers. Heat generating transformer cores and power semiconductors are mounted directly to the cases, which have threaded inserts for add-on heat sinks or pcb mounting. Devices are specified for -40 to +100°C operation and derating information is provided for operation with/without heat sinks and forced air flow.

All devices feature input pi filters, input undervoltage and overvoltage shutdown, output overvoltage protection, output current limiting, and thermal shutdown. UL, CSA, EN and IEC compliance testing is currently in progress (75V-input devices will be CE marked) as are full EMI/EMC characterizations. Contact DATEL for the latest available information.

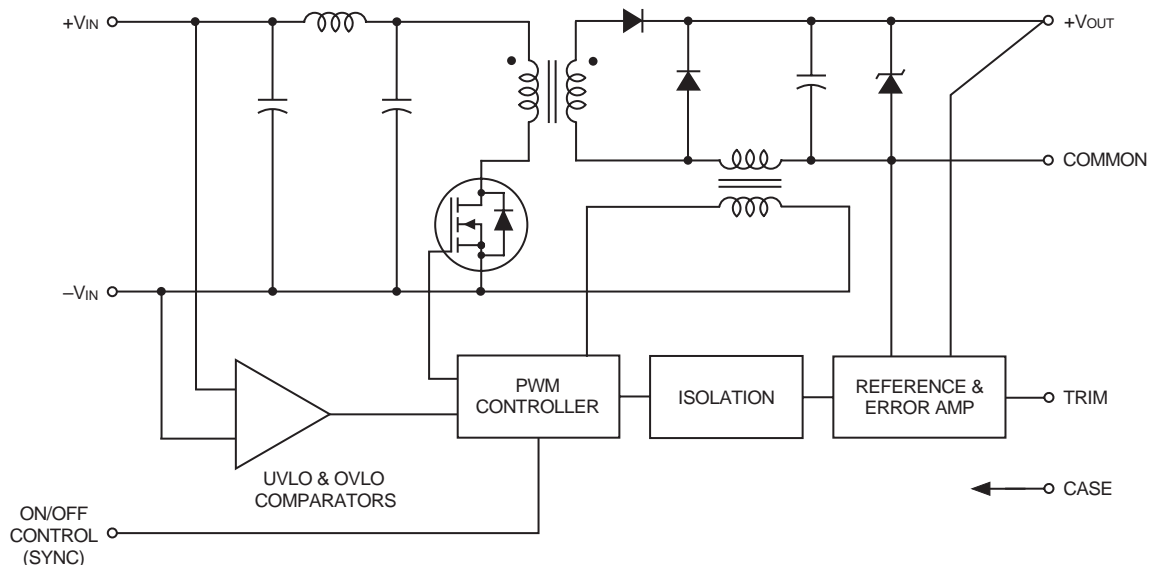

Figure 1. Simplified Schematic

Performance Specifications and Ordering Guide ①

Model	Output						Input			Efficiency		Package (Case, Pinout)
	V <sub>OUT</sub> (Volts)	I <sub>OUT</sub> (Amps)	R/N (mVp-p) ②		Regulation (Max.)		V <sub>IN</sub> Nom. (Volts)	Range (Volts)	I <sub>IN</sub> ④ (mA)	Min.	Typ.	
			Typ.	Max.	Line	Load ③						
UMP-5/5-Q12	5	5	75	100	±0.5%	±1%	24	10-36	50/1366	77%	79%	C11, P14
UMP-5/6-Q48	5	6	80	110	±0.5%	±1%	48	18-75	25/799	79%	80%	C11, P14
UMP-5/7-D24	5	7	75	100	±0.5%	±1%	24	18-36	25/1796	82%	83%	C11, P14
UMP-5/8-D48	5	8	75	100	±0.5%	±1%	48	36-75	25/1026	82%	84%	C11, P14
UMP-12/2.1-Q12	12	2.1	100	150	±0.5%	±1%	24	10-36	50/1326	80%	82%	C11, P14
UMP-12/2.5-Q48	12	2.5	100	150	±0.5%	±1%	48	18-75	30/770	82%	83%	C11, P14
UMP-12/3-D24	12	3	100	150	±0.5%	±1%	24	18-36	25/1825	82%	84%	C11, P14
UMP-12/3.3-D48	12	3.3	100	150	±0.5%	±1%	48	36-75	25/1004	83%	85%	C11, P14
UMP-15/1.7-Q12	15	1.7	100	150	±0.5%	±1%	24	10-36	50/1341	80%	82%	C11, P14
UMP-15/2-Q48	15	2	100	150	±0.5%	±1%	48	18-75	30/770	82%	83%	C11, P14
UMP-15/2.5-D24	15	2.5	100	150	±0.5%	±1%	24	18-36	25/1879	83%	84%	C11, P14
UMP-15/2.65-D48	15	2.65	100	150	±0.5%	±1%	48	36-75	25/1008	83%	85%	C11, P14

- ① Typical at T<sub>A</sub> = +25°C under nominal line voltage and full-load conditions unless otherwise noted.
- ② Ripple/Noise (R/N) measured over a 20MHz bandwidth.
- ③ 10 to 100% load.
- ④ Nominal line voltage, no-load/full-load conditions.

PART NUMBER STRUCTURE

**UMP-5/8-D48**

Output Configuration:

U = Unipolar

Fully Potted Metal Package

Nominal Output Voltage:  
5, 12 or 15 Volts

Input Voltage Range:

- Q12 = 10-36 Volts (24V nominal)
- D24 = 18-36 Volts (24V nominal)
- Q48 = 18-75 Volts (48V nominal)
- D48 = 36-75 Volts (48V nominal)

Maximum Output Current  
in Amps

OUTPUT POWER CONSIDERATIONS

UMP Model DC/DC Converters are classified, by output power, into 25, 30, 35 and 40 Watt devices. For the single-output devices listed above, the maximum available output power is the product of the nominal output voltage and the maximum allowable output current indicated within the part number (see Part Number Structure). A UMP-5/6-Q48, for example, can source 6 Amps from its 5V output (over its entire 18-75V input voltage range) delivering an output power of 30 Watts. A UMP-5/8-D48 can deliver 40 Watts.

MECHANICAL SPECIFICATIONS

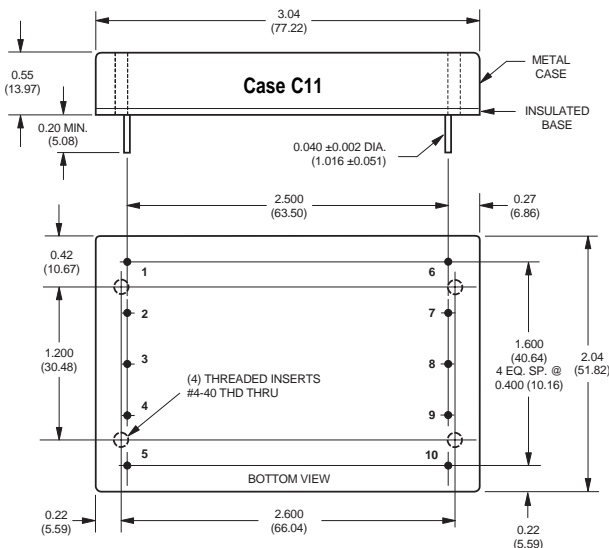

I/O Connections

Pin	Function P14
1	No Pin
2	-Input
3	+Input
4	Case
5	On/Off Control*
6	No Pin
7	No Pin
8	Common
9	+V <sub>OUT</sub>
10	Trim

\* See note 3 on next page.

Optional Heat Sink (Part Number HS-23)

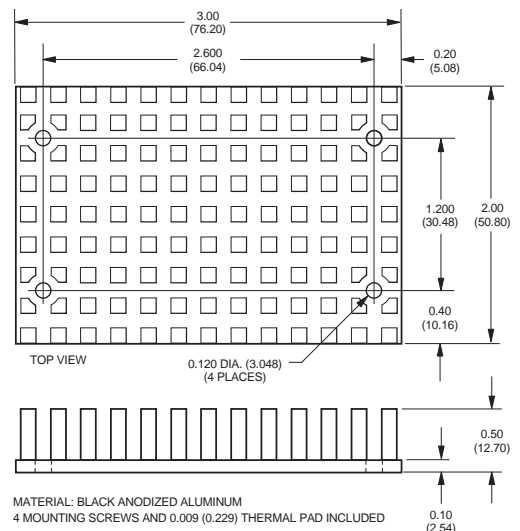

**Performance/Functional Specifications**

Typical @ T<sub>A</sub> = +25°C under nominal line voltage and full-load conditions, unless noted. ①

Input	
<b>Input Voltage Range:</b>	
"Q12" Models	10-36 Volts (24V nominal)
"D24" Models	18-36 Volts (24V nominal)
"Q48" Models	18-75 Volts (48V nominal)
"D48" Models	36-75 Volts (48V nominal)
<b>Undervoltage Lockout:</b>	
"Q12" Models	9 Volts
"D24" Models	17 Volts
"Q48" Models	17 Volts
"D48" Models	34 Volts
<b>Input Current</b>	See Ordering Guide
<b>Input Filter Type</b> ②	Pi
<b>Overshoot Protection:</b>	
"D24" and "Q12" Models	40 Volts
"D48" and "Q48" Models	80 Volts
<b>Reverse-Polarity Protection</b>	Yes (Instantaneous, 6A maximum)
<b>On/Off Control (Pin 5)</b> ③	TTL high (or open) = on, low = off
Output	
<b>V<sub>out</sub> Accuracy (50% load)</b>	±1%, maximum
<b>Temperature Coefficient</b>	±0.02% per °C
<b>Ripple/Noise (20MHz BW)</b> ②	See Ordering Guide
<b>Line/Load Regulation</b>	See Ordering Guide
<b>Efficiency</b>	See Ordering Guide
<b>Isolation Voltage</b>	1500Vdc, minimum
<b>Isolation Capacitance</b>	130pF
<b>Current Limiting</b>	Continuous, auto-recovery
<b>Overshoot Protection</b>	Zener/transorb clamp, magnetic feedback
Dynamic Characteristics	
<b>Transient Response (50% load step)</b>	200µsec max. to ±1.5% of final value
<b>Switching Frequency</b>	165kHz (±10%)
Environmental	
<b>Operating Temperature (ambient):</b>	
Without Derating	-40 to +50°C (model dependent)
With Derating	to +100°C (See Derating Curves)
Maximum Case Temperature	+100°C
<b>Storage Temperature</b>	-40 to +105°C
Physical	
<b>Dimensions</b>	2.04 x 3.04 x 0.55" (51.8 x 77.2 x 14mm)
<b>Shielding</b>	5-sided
<b>Case Connection</b>	Pin 4
<b>Case Material</b>	Zinc with a non-conductive, epoxy-based black enamel finish and plastic baseplate
<b>Pin Material</b>	Brass, solder coated
<b>Weight</b>	6 ounces (170 grams)

① These converters require a minimum 10% output loading to maintain specified regulation. Operation under no-load conditions will not damage these devices; however they may not meet all listed specifications.  
 ② Application-specific input/output filtering can be recommended or perhaps added internally upon request. Contact DATEL Applications Engineering for details.  
 ③ Applying voltage to the Control pin with no input power applied can damage the converter. The On/Off function can be replaced with a Sync function. See page 3-48 for more details.  
 ④ Listed spec is for input-to-output. Input-to-case and output-to-case isolation is 1000Vdc min.

Absolute Maximum Ratings	
<b>Input Voltage:</b>	
"Q12/D24" Models	44 Volts
"Q48/D48" Models	88 Volts
<b>Input Reverse-Polarity Protection</b>	Current must be <6A. Brief duration only. Fusing recommended.
<b>Output Overvoltage Protection</b>	
5V Outputs	6.8 Volts, limited duration
12V Outputs	15 Volts, limited duration
15V Outputs	18 Volts, limited duration
<b>Output Current</b>	Current limited. Max. current and short-circuit duration are model dependent.
<b>Storage Temperature</b>	-40 to +105°C
<b>Lead Temperature (soldering, 10 sec.)</b>	+300°C

These are stress ratings. Exposure of devices to any of these conditions may adversely affect long-term reliability. Proper operation under conditions other than those listed in the Performance/Functional Specifications Table is not implied.

**TECHNICAL NOTES**

**Floating Outputs**

Since these are isolated DC/DC converters, their outputs are "floating." Users may ground either the Common (pin 8) for normal usage or the positive side (+Output, pin 9) to effectively reverse the output polarity.

**Filtering and Noise Reduction**

All UMP 25-40 Watt DC/DC Converters achieve their rated ripple and noise specifications without the use of external input/output capacitors. In critical applications, input/output ripple and noise may be further reduced by installing electrolytic capacitors across the input terminals and/or low-ESR tantalum or electrolytic capacitors across the output terminals. The caps should be located as close to the power converters as possible. Typical values are listed in the tables below. In many applications, using values greater than those listed will yield better results.

**To Reduce Input Ripple**

"Q12/D24" Models	47µF, 50V
"Q48/D48" Models	10µF, 100V

**To Reduce Output Ripple**

5V Outputs	47µF, 10V, Low ESR
12/15V Outputs	22µF, 20V, Low ESR

In critical, space-sensitive applications, DATEL may be able to tailor the internal input/output filtering of these devices to meet your specific requirements. Contact our Applications Engineering Group for additional details.

**Input Fusing**

Certain applications and/or safety agencies may require the installation of fuses at the inputs of power conversion components. For DATEL UMP DC/DC Converters, you should use slow-blow type fuses with values no greater than the following:

V <sub>IN</sub> Range	Fuse Value
"Q12"	4A
"D24"	4A
"Q48"	3A
"D48"	2A

Temperature Derating and Electrical Performance Curves

Q12 Models (25 Watts)

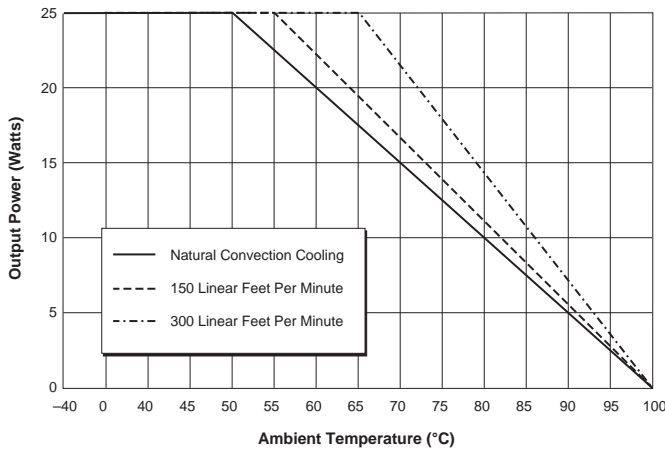

Figure 2a. Temperature Derating Without Heat Sink

Q48 Models (30 Watts)

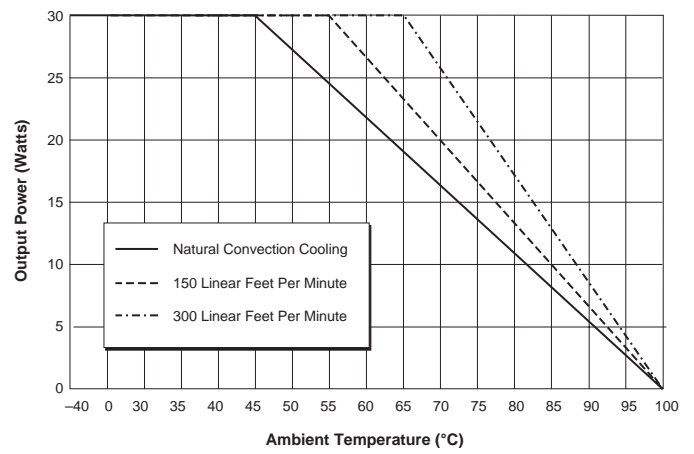

Figure 3a. Temperature Derating Without Heat Sink

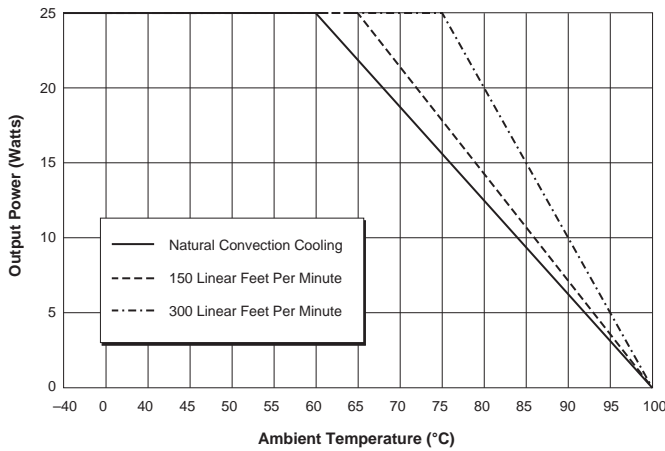

Figure 2b. Temperature Derating With Heat Sink

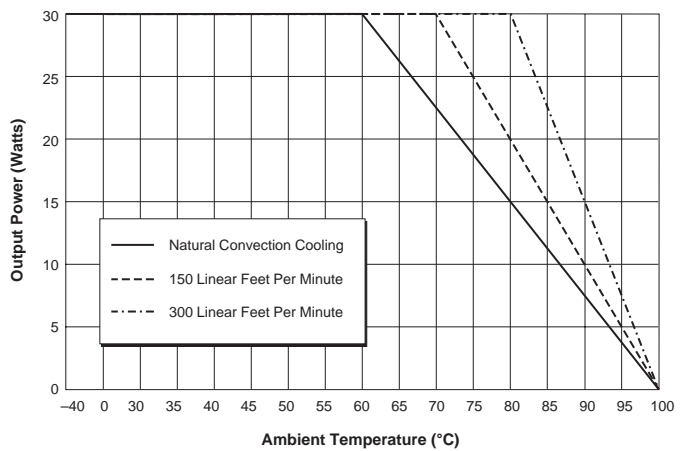

Figure 3b. Temperature Derating With Heat Sink

Model UMP-5/5-Q12

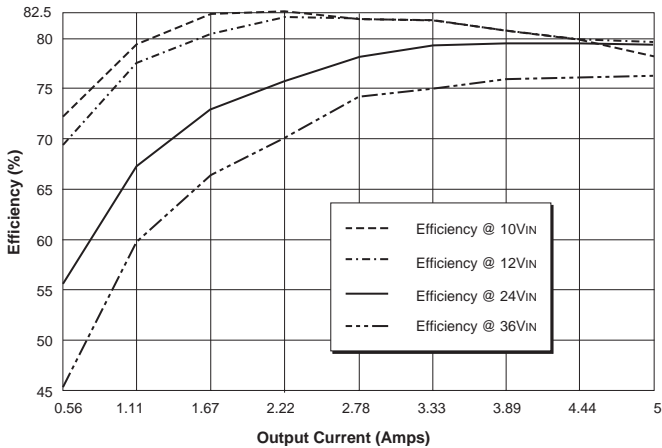

Figure 2c. Efficiency vs. Output Current and Input Voltage

Model UMP-5/6-Q48

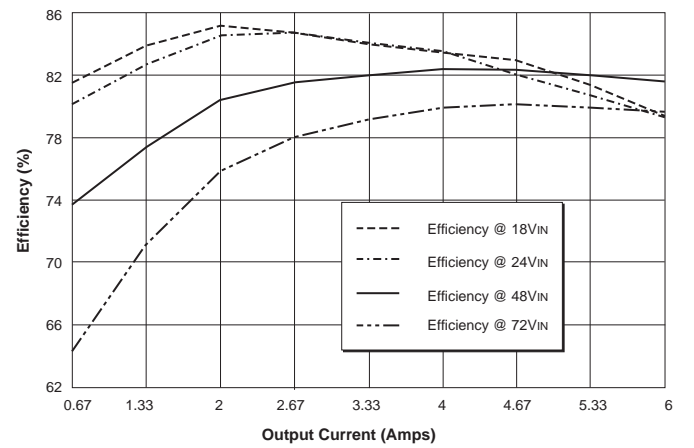

Figure 3c. Efficiency vs. Output Current and Input Voltage

Temperature Derating and Electrical Performance Curves

D24 Models (35 Watts)

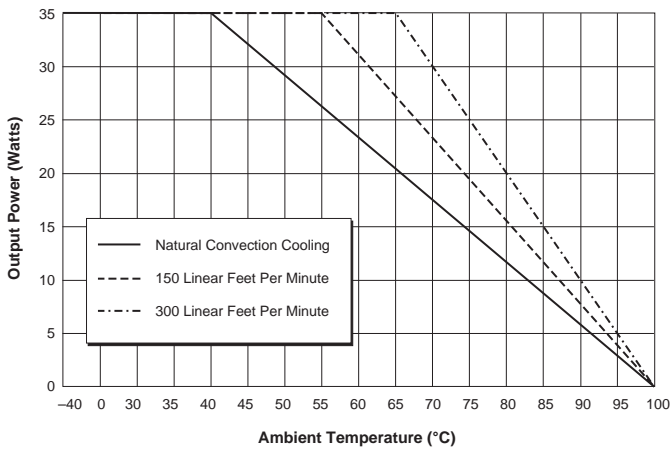

Figure 4a. Temperature Derating Without Heat Sink

D48 Models (40Watts)

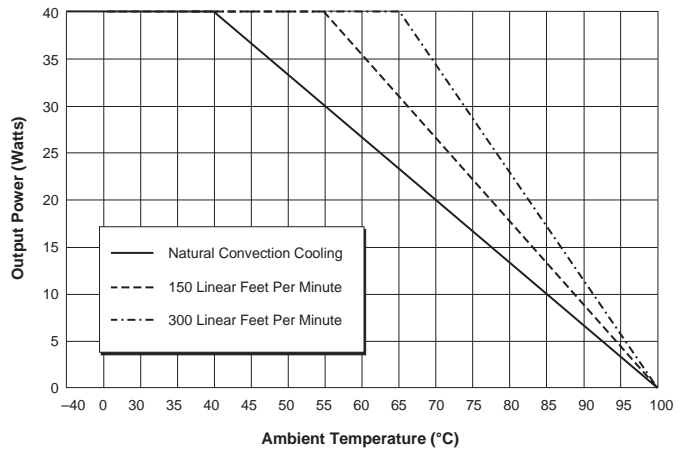

Figure 5a. Temperature Derating Without Heat Sink

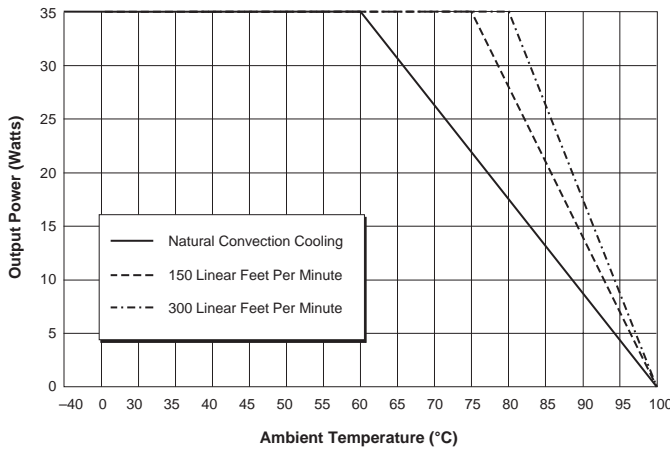

Figure 4b. Temperature Derating With Heat Sink

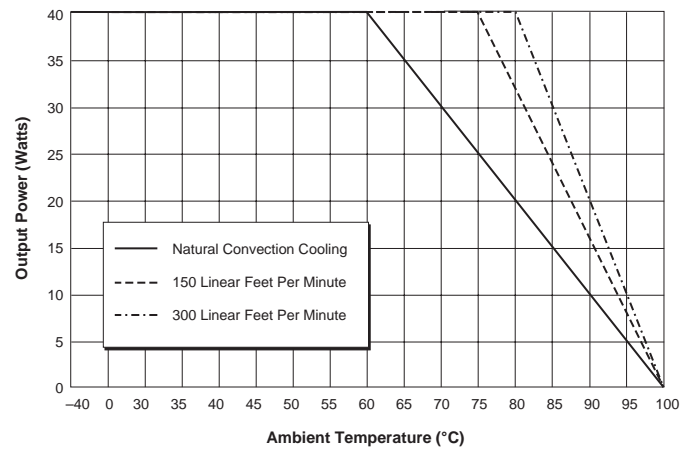

Figure 5b. Temperature Derating With Heat Sink

Model UMP-5/7-D24

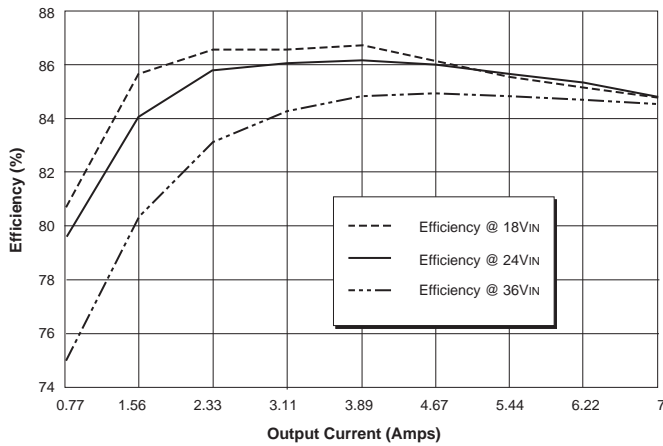

Figure 4c. Efficiency vs. Output Current and Input Voltage

Model UMP-5/8-D48

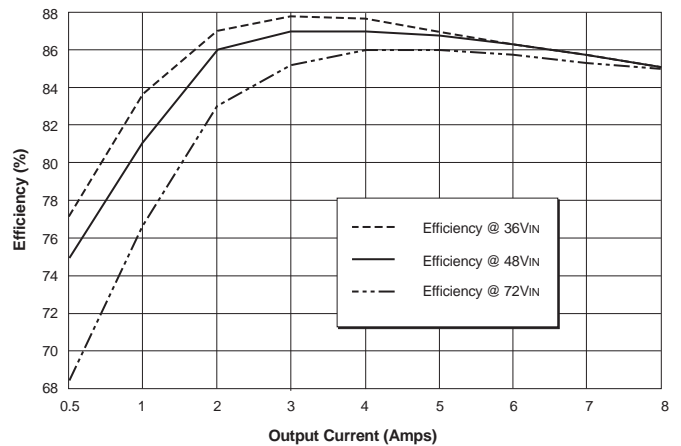

Figure 5c. Efficiency vs. Output Current and Input Voltage

**On/Off Control (Standard)**

The On/Off Control pin (pin 5) may be used for remote on/off operation. As shown in Figure 6, the control pin has an internal  $10k\Omega$  pull-up resistor to approximately 10V. The converter is designed so that it is enabled when the control pin is left open (normal mode) and disabled when the control pin is pulled low (to less than +0.8V relative to -Input, pin 2).

Dynamic control of the on/off function is best accomplished with a mechanical relay or an open-collector/open-drain drive circuit (optically isolated if appropriate). The drive circuit should obviously be able to sink approximately 1mA when activated and withstand more than 10 Volts when deactivated.

Applying an external voltage to pin 5 when no input power is applied to the converter can cause permanent damage to the converter. The on/off control function, however, is designed such that the converter can be disabled (pin 5 pulled low) while input power is ramping up and then "released" once the input has stabilized. Under these circumstances, it takes approximately 30ms for the output of the fully loaded DC/DC to ramp up and settle to within  $\pm 1\%$  of its final value after the converter has been turned on.

**Synchronization (Optional)**

In critical applications employing multiple switching DC/DC converters, it may be desirable to intentionally synchronize the switching of selected converters (so the system noise can be reduced with notch filtering) or to purposely desynchronize the converters (to lessen the current-carrying requirements on intermediate dc buses). UMP DC/DC Converters have been designed so that the On/Off Control function on pin 5 can be replaced with a Sync function. This change has to be implemented by DATEL during the product assembly process. Contact our Applications Engineering Group for additional details.

To synchronize the switching of multiple UMP converters configured with the Sync function, an external clock can be applied to pin 5 of each converter. The clock should be a TTL square wave referenced to -Input (logic high = +2 to +5 Volts, 250 $\mu$ A max.; logic low = 0 to +0.8 Volts, 70 $\mu$ A max.) with a maximum 1 $\mu$ sec "high" duration. The frequency of the synchronizing clock should be higher than that of any individual converter. Therefore, it should be 185kHz  $\pm$ 5kHz.

**Output Trimming**

$V_{OUT}$  may be trimmed  $\pm 5\%$  via a single trimpot or fixed resistor. The trimpot should be connected between +Output (pin 9) and Common (pin 8) with its wiper connected to pin 10 (Trim). A trimpot can also be used to determine the value of a single fixed resistor which can be connected between pin 10 (Trim) and pin 9 (+Output) to trim "down" the output voltages, or between pins 10 (Trim) and 6 (-Output) to trim "up" the output voltages. Fixed resistors should be metal-film types with absolute TCR's less than 100ppm/ $^{\circ}$ C to ensure stability.

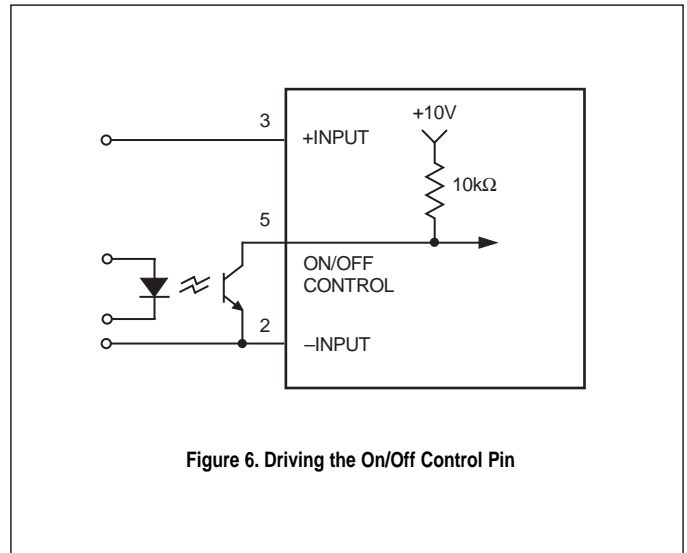

Figure 6. Driving the On/Off Control Pin

**Case Connection**

Unlike most other DC/DC converters, UMP DC/DC's do not have their metal case connected to one of their input pins. The "uncommitted" case is connected to pin 4 which, depending on your system configuration, should be connected to either +Input (pin 3) or -Input (pin 2).

CUSTOM CAPABILITIES

DATEL's world-class design, development and manufacturing team stands ready to work with you to deliver the exact power converter you need for your demanding, large volume, OEM applications. More importantly . . . we'll do it on time and within budget!

Our experienced applications and design staffs; quick-turn prototype capability; highly automated, SMT assembly facilities; and in-line SPC quality-control techniques combine to give us the unique ability to design and deliver any quantity of power converters to the highest standards of quality and reliability.

We have compiled a large library of DC/DC designs that are currently used in a variety of telecom, medical, computer, railway, aerospace and industrial applications. We may already have the converter you need.

Contact us. Our goal is to provide you the highest-quality, most cost-effective power converters available.

EMI RADIATED EMISSIONS

If you're designing with EMC in mind, please note that all of DATEL's UMP 25-40 Watt DC/DC Converters have been characterized for radiated and conducted emissions in our new EMI/EMC laboratory. Testing is conducted in an EMCO 5305 GTEM test cell utilizing EMCO automated EMC test software. Radiated emissions are tested to the limits of FCC Part 15, Class B and CISPR 22 (EN 55022), Class B. Correlation to other specifications can be supplied upon request. Radiated emissions plots to FCC and CISPR 22 for model UMP-5/8-D48 appear below. Published EMC test reports are available for each model number. Contact DATEL's Applications Engineering Department for more details.

**UMP-5/8-D48 Radiated Emissions  
FCC Part 15 Class B, 3 Meters  
Converter Output = +5Vdc @ +6.45 Amps**

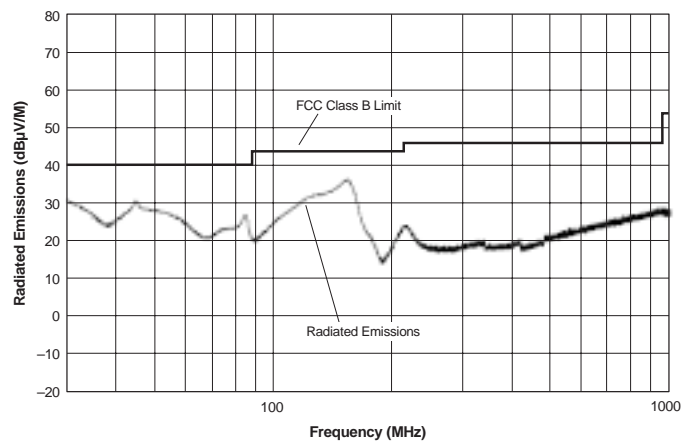

**UMP-5/8-D48 Radiated Emissions  
EN 55022 Class B, 10 Meters  
Converter Output = +5Vdc @ +6.45 Amps**

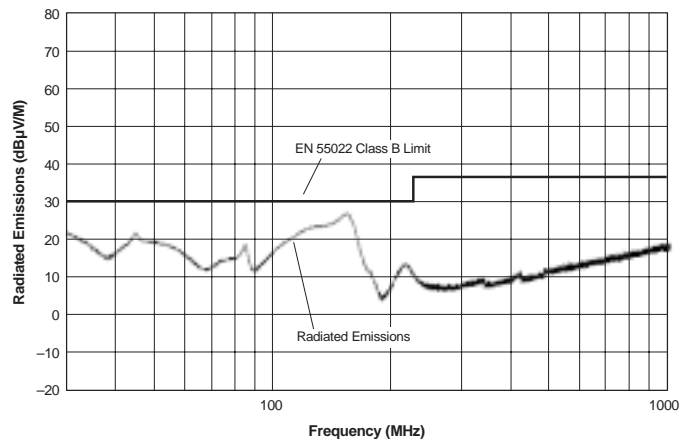

## Quality and Reliability

The UPB Models are the latest DC/DC Converters to emerge from DATEL's new, company-wide approach to designing and manufacturing the most reliable power converters available. The five-pronged program draws our Quality Assurance function into all aspects of new-product design, development, characterization, qualification and manufacturing.

### Design for Reliability

Design for Reliability is woven throughout our multi-phased, new-product-development process. Design-for-reliability practices are fully documented and begin early in the new-product development cycle with the following goals:

1. To work from an approved components/vendors list ensuring the use of reliable components and the rigorous qualification of new components.
2. To design with safety margins by adhering to a strict set of derating guidelines and performing theoretical worst-case analyses.
3. To locate potential design weaknesses early in the product-development cycle by using extensive HALT (Highly Accelerated Life Testing).
4. To prove that early design improvements are effective by employing a thorough FRACA (Failure Reporting Analysis and Corrective Action) system.

### HALT Testing

The goal of the accelerated-stress techniques used by DATEL is to force device maturity, in a short period of time, by exposing devices to excessive levels of "every stimulus of potential value." We use HALT (Highly Accelerated Life Testing) repeatedly during the design and early manufacturing phases to detect potential electrical and mechanical design weaknesses that could result in possible future field failures.

During HALT, prototype and pre-production DC/DC converters are subjected to progressively higher stress levels induced by thermal cycling, rate of temperature change, vibration, power cycling, product-specific stresses (such as dc voltage variation) and combined environments. The stresses are not meant to simulate field environments but to expose any weaknesses in a product's electro/mechanical design and/or assembly processes. The goal of HALT is to make products fail so that device weaknesses can be analyzed and strengthened as appropriate. Applied stresses are continually stepped up until products eventually fail. After corrective actions and/or design

Typical HALT Profile

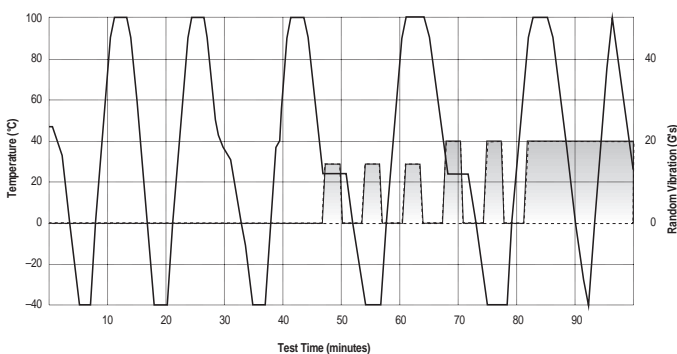

changes, stresses are stepped up again and the cycle is repeated until the "fundamental limit of the technology" is determined.

DATEL has invested in a Qualmark OVS-1 HALT tester capable of applying voltage and temperature extremes as well as 6-axis, linear and rotational, random vibration. A typical HALT profile (shown above) consists of thermal cycling (-55 to +125°C, 30°C/minute) and simultaneous, gradually increasing, random longitudinal and rotational vibration up to 20G's with load cycling and applied-voltage extremes added as desired. Many devices in DATEL's new A-Series could not be made to fail prior to reaching either the limits of the HALT chamber or some previously known physical limit of the device. We also use the HALT chamber and its ability to rapidly cool devices to verify their "cold-start" capabilities.

### Qualification

For each new product, electrical performance is verified via a comprehensive characterization process and long-term reliability is confirmed via a rigorous qualification procedure. The qual procedure includes such strenuous tests as thermal shock and 500 hour life. Qual testing is summarized below.

Qualification Testing

Qualification Test	Method/Comments
HALT	DATEL in-house procedure
High Temperature Storage	Max. rated temp., 1,000 hours
Thermal Shock	10 cycles, -55 to +125°C
Temperature/Humidity	+85°C, 85% humidity, 48 hours
Lead Integrity	DATEL in-house procedure
Life Test	+70°C, 500 hours*
Marking Permanency	DATEL in-house procedure
End Point Electrical Tests	Per product specification

\* Interim electrical test at 200 hours.

### In-Line Process Controls and Screening

A combination of statistical sampling and 100% inspection techniques keeps our assembly line under constant control. Parameters such as solder-paste thickness, component placement, cleanliness, etc. are statistically sampled, charted and fine tuned as necessary. Visual inspections are performed by trained operators after pick-and-place, soldering and cleaning operations. Units are 100% electrically tested prior to potting. All devices are temperature cycled, burned-in, hi-pot tested and final-electrical tested prior to external visual examination, packing and shipping.

### Rapid Response to Problems

DATEL employs an outstanding corrective-action system to immediately address any detected shortcomings in either products or processes. Whenever our assembly, quality or engineering personnel spot a product/process problem, or if a product is returned with a potential defect, we immediately perform a detailed failure analysis and, if necessary, undertake corrective actions. Over time, this system has helped refine our assembly operation to yield one of the lowest product defect rates in the industry.



ISO 9001

DS-0393 10/98

DATEL, Inc. 11 Cabot Boulevard, Mansfield, MA 02048-1151  
Tel: (508) 339-3000 (800) 233-2765 Fax: (508) 339-6356  
Internet: www.datel.com Email: sales@datel.com  
Data Sheet Fax Back: (508) 261-2857

DATEL (UK) LTD. Tadley, England Tel: (01256)-880444  
DATEL S.A.R.L. Montigny Le Bretonneux, France Tel: 01-34-60-01-01  
DATEL GmbH München, Germany Tel: 89-544334-0  
DATEL KK Tokyo, Japan Tel: 3-3779-1031, Osaka Tel: 6-354-2025