



Single Output UNR Series

Non-Isolated, 3.3V 8-40 Watt, DC/DC Converters

Features

- Low cost
- 5V or 12V inputs
- 3.3V \pm 1% (\pm 33mV) outputs
- \pm 0.25% (\pm 8mV) max. line regulation
- \pm 0.5% (\pm 17mV) max. load regulation
- Guaranteed efficiencies to 86%
- Power densities to 29W/in³
- High output current ... small packages:
3A (1" x 1" package)
8A (2" x 1" package)
12A (2" x 2" package)
- No heat sinks required
- -40 to +100°C operating temperatures
- On/off/sync control
- UL, CSA, IEC safety approvals
- Customized V_{OUT} (Contact DATEL)

New low-voltage microprocessor and memory chips are driving the migration from centralized to distributed power processing in modern telecommunication and computer systems. Powering these new chips requires local, on-board power converters that rapidly source large amounts of current while maintaining accurate voltages with minimal ripple and noise. The distribution losses, unpredictable regulation and poor transient response of traditional centralized power systems are no longer acceptable. Power processing at the "point-of-use" is frequently the only way to achieve desired performance.

DATEL's new UNR Series of non-isolated, 3.3V output, 5V or 12V input, switching DC/DC converters were specifically designed for on-board usage in today's mixed-logic 5V/3.3V systems. They also support those systems that are already drawing maximum current from their 5V buses and must resort to their 12V buses.

These low-cost, extremely efficient (typically 90%) power converters are capable of delivering full rated output currents (2.5-12 Amps) while maintaining low case temperatures without the need for heat sinks or any auxiliary cooling. UNR Series devices combine proven circuit architectures, contemporary SMT-on-ceramic and SMT-on-pcb assembly techniques, and a new thermally-conductive potting compound to achieve high output power in the smallest packages possible.

DATEL is currently developing UNR Series devices that incorporate active load sharing with output current/voltage-sensing capabilities. We can also quickly modify existing devices for application-specific output voltages from 1.8 to 5 Volts. Please contact us with your unique requirements ... we may already have the product you need.

DATEL also makes a complete line of isolated 3.3V DC/DC converters that operate from wide-range input voltages from 4.6 to 72V.

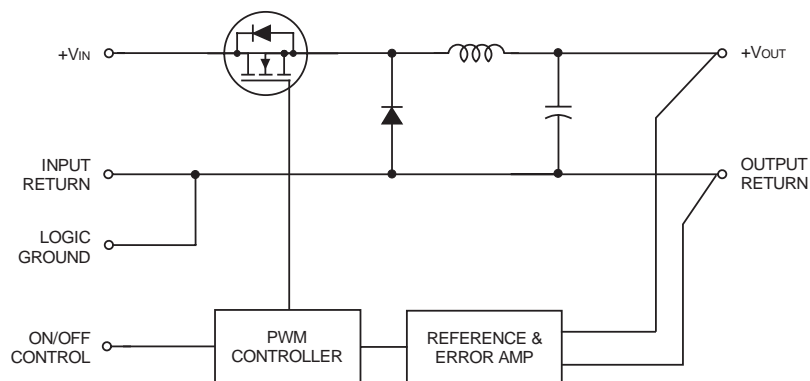

Figure 1. Simplified Schematic

Performance Specifications and Ordering Guide ^①

Model	Output					Input			Efficiency (Min.)	Package (Case, Pinout)
	V _{OUT} (Volts)	I _{OUT} (mA, Max.)	Ripple/Noise ^② (mVp-p, Max.)	Regulation (Max.)		V _{IN} Nom. (Volts)	Range (Volts)	I _{IN} ^④ (mA, Max.)		
				Line	Load ^③					
UNR-3.3/3000-D5	3.3	3000	140	±0.25%	±0.5%	5	4.75-5.5	25/2390	85%	C7, P9
UNR-3.3/2500-D12	3.3	2500	100	±0.2%	±0.5%	12	10.8-13.2	35/856	82%	C7, P10
UNR-3.3/8000-D5	3.3	8000	75	±0.25%	±0.5%	5	4.75-5.5	25/6330	86%	C5, P9
UNR-3.3/12000-D5	3.3	12000	125	±0.25%	±0.75%	5	4.75-5.5	50/9700	84%	C6, P9

- ① Typical at T_A = +25°C under nominal line voltage and full load conditions unless otherwise noted. These devices require external input and output capacitors for normal operation.
- ② 20MHz bandwidth. Specified with external I/O capacitors. See Technical Notes.
- ③ 10% to 100% load.
- ④ Nominal line voltage, no load/full load conditions.

Part Number Structure

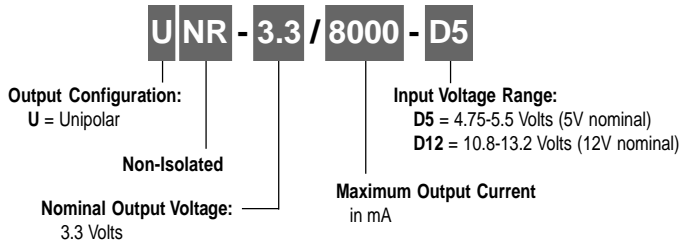

Mechanical Specifications

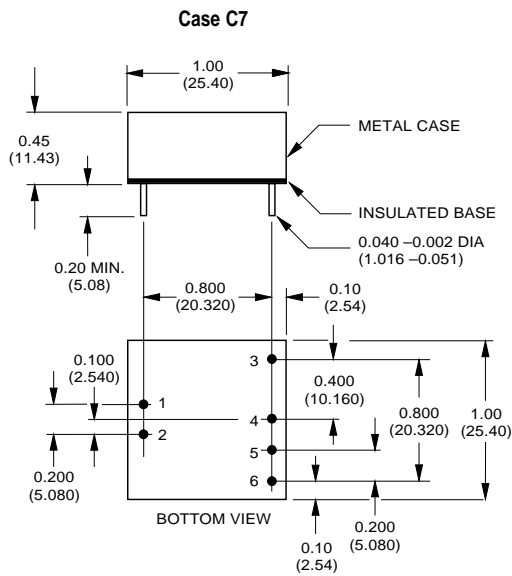

I/O Connections		
Pin	Function P9	Function P10
1	Logic Gnd.	Do Not Connect
2	On/Off Control	No Connect
3	+Output	+Output
4	Output Rtn.	Output Rtn.
5	Input Rtn.	Input Rtn.
6	+Input	+Input

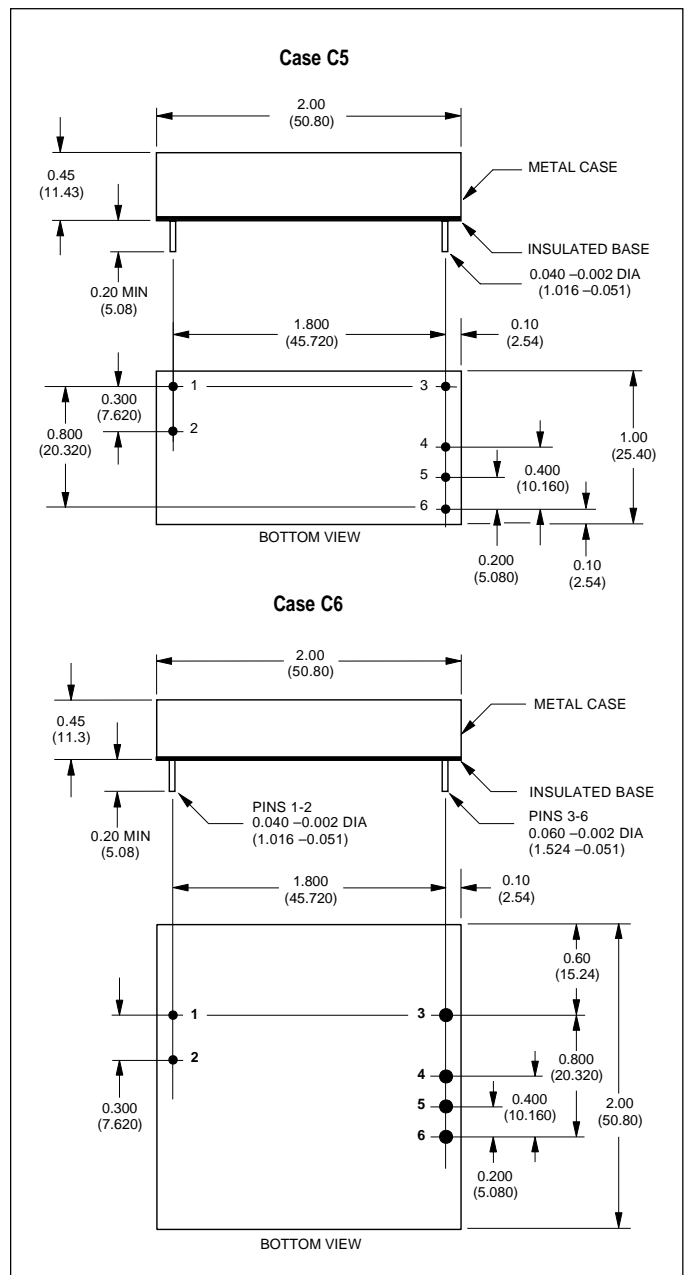

Performance/Functional Specifications

Typical @ T_A = +25°C under nominal line voltage and full load conditions unless noted. ① ②

Input	
Input Voltage Range:	
"D5" Models	4.75-5.5 Volts (5V nominal)
"D12" Models	10.8-13.2 Volts (12V nominal)
Input Current	See Ordering Guide
Input Filter Type ②	None
Overvoltage Shutdown	None
Reverse-Polarity Protection	Yes (Instantaneous, 10A maximum)
On/Off (Sync.) Control (Pin 2) ③	TTL high = off, low (or open) = on
Output	
V_{OUT} Accuracy (50% load)	±1%
Temperature Coefficient	±0.02% per °C
Ripple/Noise (20MHz BW) ②	See Ordering Guide
Line/Load Regulation	See Ordering Guide
Efficiency	See Ordering Guide
Current Limiting	Auto-recovery
Dynamic Characteristics	
Transient Response (25% load step)	100µsec to ±1.5% of final value
Switching Frequency:	
"D5" Models	75kHz (±5kHz)
"D12" Models	90kHz (±5kHz)
Environmental	
Operating Temperature (ambient):	
Without Derating:	
3A and 8A "D5" Models	-40 to +50°C
12A "D5" and 2.5A "D12" Models	-40 to +45°C
With Derating	to +100°C (See Derating Curves)
Storage Temperature	-55 to +105°C
Physical	
Dimensions:	
3A "D5" and 2.5A "D12" Models	1" x 1" x 0.45" (25 x 25 x 11.4mm)
8A "D5" Model	2" x 1" x 0.45" (51 x 25 x 11.4mm)
12A "D5" Model	2" x 2" x 0.45" (51 x 51 x 11.4mm)
Shielding	5-sided ④
Case Connection	Pin 4 (Output Return)
Case Material	Corrosion resistant steel with epoxy-based enamel finish
Pin Material	Brass, solder coated
Weight:	
3A "D5" and 2.5A "D12" Models	1 ounce (28.4 grams)
8A "D5" Model	1.5 ounces (42.5 grams)
12A "D5" Model	2 ounces (56.7 grams)

- ① These power converters require a minimum 10% loading to maintain specified regulation. Operation under no-load conditions will not damage these devices, however, they may not meet all listed specifications.
- ② These power converters do not have internal input filters and do require external input and output capacitors to achieve rated specifications. Application-specific internal input/output filtering can be added upon request. Contact DATEL for details.
- ③ On/Off Control pins are included on "D5" models only. See Technical Notes for details. Applying a voltage to the Control pin when no input power is applied to the converter can cause permanent damage to the converter.
- ④ Cases can be provided with 6-sided shielding. Contact DATEL for details.

Absolute Maximum Ratings

These are stress ratings. Exposure of devices to any of these conditions may adversely affect long-term reliability. Proper operation under conditions other than those listed in the Performance/Functional Specifications Table is not implied. Storage temperatures have been verified for 168 hours.

Input Voltage:	
"D5" Models	7 Volts
"D12" Models	15 Volts
Input Reverse-Polarity Protection	Current must be <10A. Brief duration. Fusing recommended.
Output Overvoltage Protection	None
Output Current	Current limited. Max. current and short-circuit duration model dependent.
Storage Temperature	-55 to +105°C
Lead Temperature (soldering, 10sec.)	+300°C

Temperature Derating

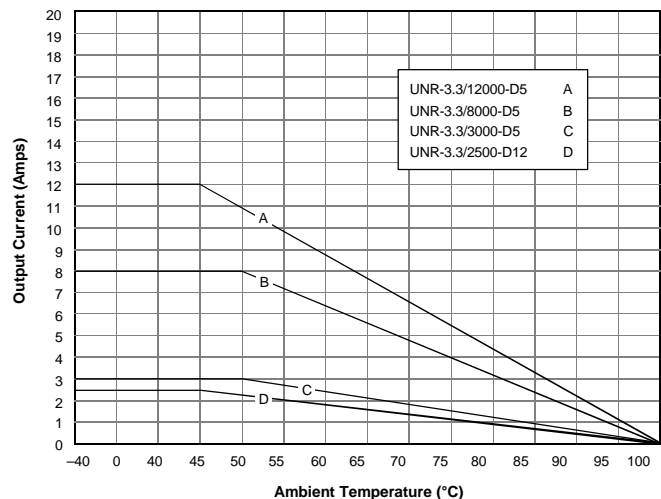

Technical Notes

Input Capacitors

As shown in the simplified schematic, UNR Series power converters do not have internal input capacitors. Users must install external input capacitors for the devices to achieve specified operation. The input capacitor functions as a true energy-storage element. Its required capacitance varies as a function of applied line voltage. Additionally, as the power converter's input FET switch cycles on and off, the input capacitor must have the ability to rapidly supply pulses of relatively high current. Therefore, required rms-ripple-current capabilities of the input capacitor will vary as a function of the power converter's load current. Rather than install a large, expensive,

internal capacitor that addresses all possible load conditions, we have chosen to leave the capacitor out so that you may select a cost-effective component appropriate to your particular application.

Use the charts below to determine how much input capacitance is required as a function of input voltage and also to determine the required rms-ripple-current capabilities of the needed capacitor as a function of output load current. Note that "low-line" conditions will require proportionally more input capacitance in order to maintain the required energy levels and that higher output currents will obviously require higher input currents. Contact DATEL's Applications Engineering Group if you have any questions.

UNR-3.3/12000-D5

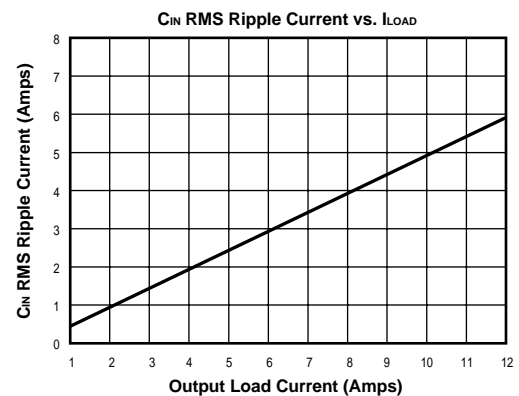
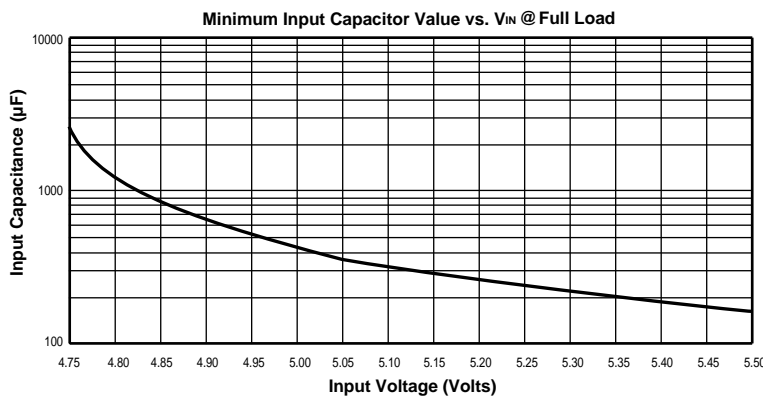

UNR-3.3/8000-D5

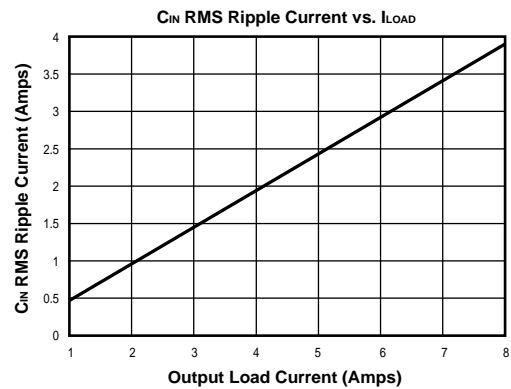
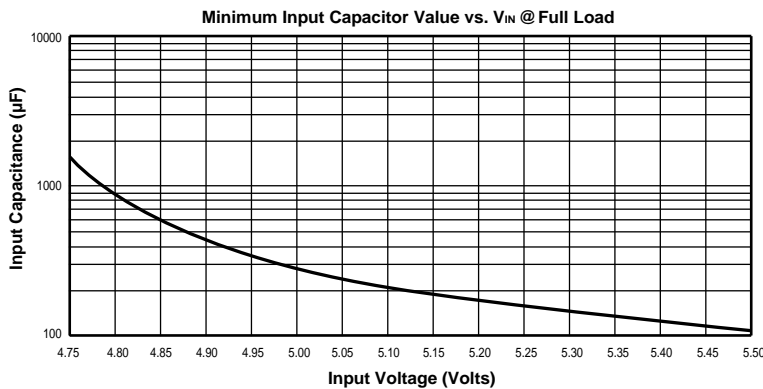

UNR-3.3/3000-D5

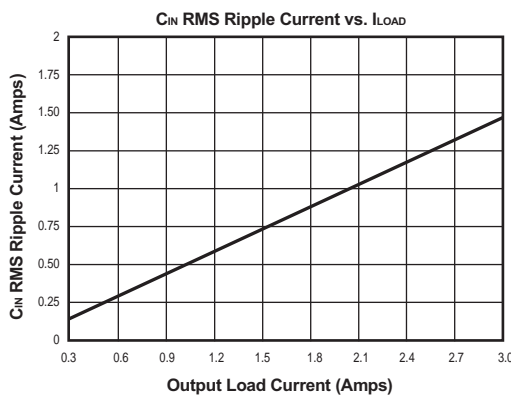
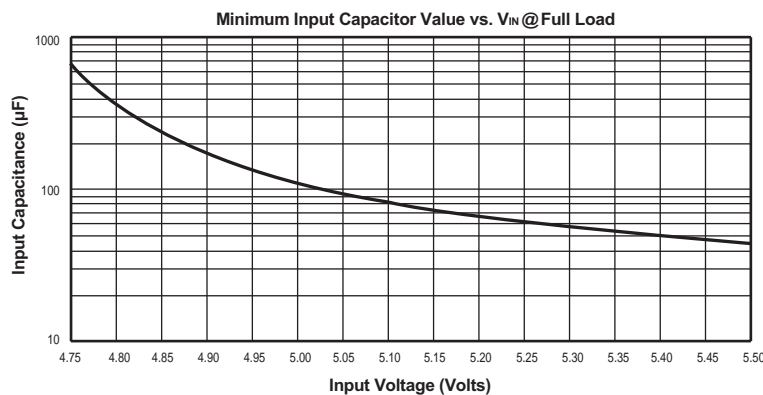

Reducing Output Ripple/Noise

In addition to their internal output capacitors, UNR Series DC/DC converters require the installation of external output capacitors to achieve their published ripple/noise specifications. The selected caps should be low-ESR, tantalum or electrolytic types, and they should be located as close to the converters as possible. Recommended values are listed in the table below.

Part Number	Output Capacitor
UNR-3.3/3000-D5	470 μ F, 6V, Low ESR
UNR-3.3/2500-D12	100 μ F, 6V, Low ESR
UNR-3.3/8000-D5	1000 μ F, 6V, Low ESR
UNR-3.3/12000-D5	1000 μ F, 6V, Low ESR

Remote On/Off Control and the Logic Ground Pin

The On/Off Control pin (pin 2 on "D5" units) may be used for digitally controlled on/off operation. A TTL logic high (+2 to +5 Volts, 250 μ A max.) applied to pin 2 disables the converter. A TTL logic low (0 to +0.8 Volts, 70 μ A max.), or no connection, enables the converter. Control voltages should be referenced to pin 1 (Logic Ground). Applying a voltage to the Control pin when no input power is applied to the converter can cause permanent damage to the converter.

The Input Return (pin 5), Output Return (pin 4) and Logic Ground (pin 1 on "D5" models) are all tied together internal to the device. To the extent possible, load current should be returned to pin 4. Pin 5 should be connected back to the input supply with as low an impedance as possible so that input return current flows through pin 5. The internal trace leading to the Logic Ground pin is not designed to carry high currents. Devices should not be installed in a manner that results in high current flow through pin 2 (i.e., pins 4 and 5 should never be left open or attached via high-impedance connections).

"D12" models do not have On/Off Control functions. Their pin 2 (No Connect) is not electrically connected to any internal circuitry and may be tied to any convenient external run. Their pin 1 (Do Not Connect) is a test point. Pin 1 may be soldered to an island for mechanical mounting purposes, but it should not have an electrical connection to external circuitry.

Synchronization

If desired, a synchronizing clock can be applied to pin 2 on "D5" models to control the converter's internal clock oscillator. The applied clock should be a square wave with a maximum 1 μ sec "high" duration and an amplitude between +2V and +5V (see On/Off Control) referenced to pin 1 (Logic Ground). The frequency of the synchronizing clock must be higher than that of the standalone converter. Therefore, it should be 85kHz \pm 5kHz.

Synchronization Issues

Because of the comparatively small differential between their input and output voltages, 5V-to-3.3V DC/DC converters capable of sourcing high output current also demand high input current. Most of these high-current DC/DC's use switching architectures employing fixed-frequency clock oscillators, and their input currents include both dc (average) and ac (ripple) components.

If you have multiple DC/DC's connected to a single main power bus, you may need to consider that all the converters will not be switching at exactly the same frequency (due to normal component and manufacturing tolerances). Consequently, the converters may randomly "self-synchronize" in their demanding of peak current from the main power bus. Peak currents all drawn simultaneously can be significantly greater than the sum of average input currents. This phenomenon can result in unwanted harmonic interactions from converter to converter along the power bus.

One solution to this potential problem is to use the converters' On/Off Control function to effectively "de-synchronize" their clocks. Forcing the multiple clocks to be out of phase with each other relaxes the required performance characteristics of the main power bus so the bus now has to carry the sum of the average currents of all the converters plus only one peak current.

Custom Capabilities

DATEL's world-class design, development and manufacturing team stands ready to work with you to deliver the exact power converter you need for your demanding, large volume, OEM applications. And ... we'll do it on time and within budget!

Our experienced applications and design staffs; quick-turn prototype capability; highly automated, SMT assembly facilities; and in-line SPC quality-control techniques combine to give us the unique ability to design and deliver any quantity of power converters to the highest standards of quality and reliability.

We have compiled a large library of DC/DC designs that are currently used in a variety of telecom, medical, computer, railway, aerospace and industrial applications. We may already have the converter you need.

Contact us. Our goal is to provide you the highest-quality, most cost-effective power converters available.

EMI Radiated Emissions

If you're designing with EMC in mind, please note that all of DATEL's UNR 8-40 Watt DC/DC Converters have been characterized for radiated and conducted emissions in our new EMI/EMC laboratory. Testing is conducted in an EMCO 5305 GTEM test cell utilizing EMCO automated EMC test software. Radiated emissions are tested to the limits of FCC Part 15, Class B and CISPR 22 (EN 55022), Class B. Correlation to other specifications can be supplied upon request. Radiated emissions plots to FCC and CISPR 22 for model UNR-3.3/8000-D5 appear below. Published EMC test reports are available for each model number. Contact DATEL's Applications Engineering Department for more details.

UNR-3.3/8000-D5 Radiated Emissions
FCC Part 15 Class B, 3 Meters
Converter Output = 3.3Vdc @ 6.4A

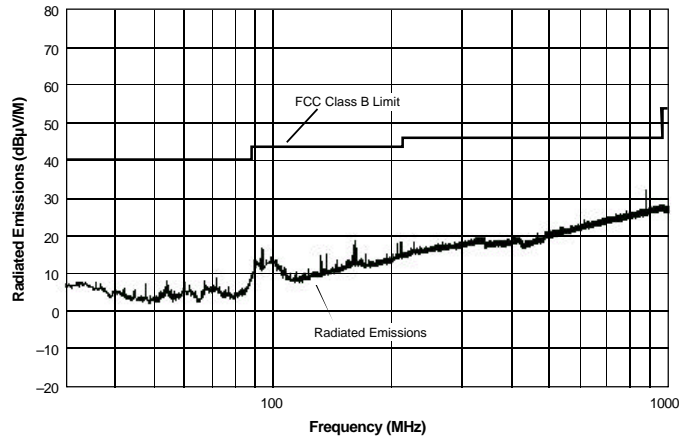

UNR-3.3/8000-D5 Radiated Emissions
EN 55022 Class B, 10 Meters
Converter Output = 3.3Vdc @ 6.4A

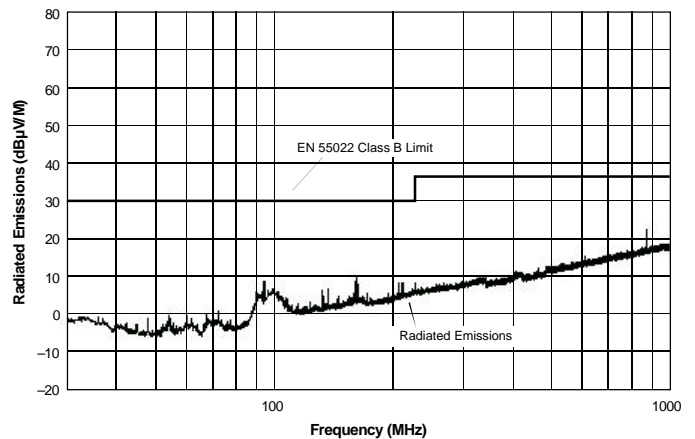

DS-0329C 3/97

DATEL, Inc. 11 Cabot Boulevard, Mansfield, MA 02048-1151
Tel: (508) 339-3000 (800) 233-2765
Fax: (508) 339-6356 Email: datellit@mcimail.com
Data Sheet Fax Back: (508) 261-2857

DATEL (UK) LTD. Tadley, England Tel: (01256)-880444
DATEL S.A.R.L. Montigny Le Bretonneux, France Tel: 01-34-60-01-01
DATEL GmbH München, Germany Tel: 89-544334-0
DATEL KK Tokyo, Japan Tel: 3-3779-1031, Osaka Tel: 6-354-2025

DATEL makes no representation that the use of its products in the circuits described herein, or the use of other technical information contained herein, will not infringe upon existing or future patent rights. The descriptions contained herein do not imply the granting of licenses to make, use, or sell equipment constructed in accordance therewith. Specifications are subject to change without notice. The DATEL logo is a registered DATEL, Inc. trademark.

NON-ISOLATED DC/DC CONVERTER SELECTION GUIDE

2.5V SINGLE OUTPUT

Output Current (Amps, Max.)	Input Voltage, Nominal (Range) (Volts)	Package ①		Regulation		Ripple/Noise ② (mVp-p)	Efficiency (Min.)	DATEL Model Number	DATEL Data Sheet
		Dimensions (Inches)	Case, Pinout	Line (Max.)	Load (Max.)				
2	5 (4.75-5.5)	1 x 1 x 0.45	C7, P9	±0.4%	±0.5%	30	83%	UNR-2.5/2-D5	UNR, 5W
8	5 (4.75-5.5)	2 x 1 x 0.375	C5A, P9	±0.1%	±0.5%	40	86%	UNR-2.5/8-D5	UNR, 20/25W
	12 (10.4-13.6)	2 x 1 x 0.375	C5A, P9	±0.1%	±0.5%	60	85%	UNR-2.5/8-D12	UNR, 20/25W
10	5 (4.75-5.5)	2 x 1 x 0.375	C5A, P9	±0.1%	±0.5%	40	85%	UNR-2.5/10-D5	UNR, 20/25W
	12 (10.4-13.6)	2 x 1 x 0.375	C5A, P9	±0.1%	±0.5%	60	83%	UNR-2.5/10-D12	UNR, 20/25W
12	5 (4.75-5.5)	2 x 1 x 0.375	③	±0.25%	±0.5%	50	86%	UNR-2.5/12-D5 ③	Contact DATEL
20	5 (4.75-5.5)	2 x 2 x 0.45	③	±0.25%	±0.5%	50	84%	UNR-2.5/20-D5 ③	Contact DATEL

3.3V SINGLE OUTPUT

3	5 (4.75-5.5)	1 x 1 x 0.45	C7, P9	±0.4%	±0.5%	30	86%	UNR-3.3/3-D5	UNR, 10W.
	7.5 (4.75-13.6)	2 x 0.4 x 0.8 ④	B1, P18	±0.5%	±1.5%	50	90% ⑥	UNS-3.3/3-D5	UNS, 10/15W
	7.5 (4.75-13.6)	2 x 0.8 x 0.4 ⑤	B2, P18	±0.5%	±1.5%	50	90% ⑥	UNS-3.3/3-D5D	UNS, 10/15W
	12 (10.4-13.6)	1 x 1 x 0.45	C7, P9	±0.25%	±0.5%	90	87%	UNR-3.3/3-D12	UNR, 10W
8	5 (4.75-5.5)	2 x 1 x 0.375	C5A, P9	±0.1%	±0.5%	40	88%	UNR-3.3/8-D5	UNR, 26/33W
	12 (10.4-13.6)	2 x 1 x 0.375	C5A, P9	±0.1%	±0.5%	60	86%	UNR-3.3/8-D12	UNR, 26/33W
10	5 (4.75-5.5)	2 x 1 x 0.375	C5A, P9	±0.1%	±0.5%	40	86%	UNR-3.3/10-D5	UNR, 26/33W
	12 (10.4-13.6)	2 x 1 x 0.375	C5A, P9	±0.1%	±0.5%	60	85%	UNR-3.3/10-D12	UNR, 26/33W
12	5 (4.75-5.5)	2 x 1 x 0.375	③	±0.25%	±0.5%	50	87%	UNR-3.3/12-D5 ③	Contact DATEL
15	5 (4.75-5.5)	2 x 2 x 0.45	③	±0.25%	±0.5%	50	84%	UNR-3.3/15-D5 ③	Contact DATEL

5V SINGLE OUTPUT

3	12 (6-16.5)	2 x 0.4 x 0.8 ④	B1, P18	±0.5%	±1.5%	50	92% ⑥	UNS-5/3-D12	UNS, 10/15W
	12 (6-16.5)	2 x 0.8 x 0.4 ⑤	B2, P18	±0.5%	±1.5%	50	92% ⑥	UNS-5/3-D12D	UNS, 10/15W
5 ⑦	12 (10.4-13.6)	2 x 1 x 0.5	C13, P21	±0.25%	±0.5%	60	87%	UNR-5/5-D12	UNR, 25W

Listed specifications are typical at T_A = +25°C under nominal line voltage and full-load conditions unless noted.

① See individual product data sheets for mechanical specifications and pinouts.

② Ripple/Noise is specified over a 20MHz bandwidth.

③ Listed specifications for these products are preliminary.

④ 10-pin SIP package.

⑤ 10-pin DIP package.

⑥ Listed specification is a typical.

⑦ Output voltage is user adjustable from 3.3 to 6V.

Data sheet fax back: (508)261-2857 • Visit us on the internet: www.datel.com

DATEL, Inc., 11 Cabot Boulevard, Mansfield, MA 02048 • Tel: (508)339-3000 Fax: (508)339-6356 • Email: sales@datel.com