

REFERENCE FREQUENCY 16.368 MHz, 2ND IF FREQUENCY 4.092 MHz RF/IF FREQUENCY DOWN-CONVERTER + PLL FREQUENCY SYNTHESIZER IC FOR GPS RECEIVER

DESCRIPTION

The μPB1005GS is a silicon monolithic integrated circuit for GPS receiver. This IC is designed as double conversion RF block integrated RF/IF down-converter + PLL frequency synthesizer on 1 chip.

The μPB1005GS features shrink package, fixed prescaler and supply voltage. The 30-pin plastic SSOP package is suitable for high density surface mounting. The fixed division internal prescaler is needless to input serial counter data. Supply voltage is 3 V. Thus, the μPB1005GS can make RF block fewer components and lower power consumption.

This IC is manufactured using NEC's 20 GHz fr NESAT™III silicon bipolar process. This process uses direct silicon nitride passivation film and gold electrodes. These materials can protect the chip surface from pollution and prevent corrosion/migration. Thus, this IC realizes excellent performance, uniformity and reliability.

FEATURES

- Double conversion : $f_{REFin} = 16.368 \text{ MHz}$, $f_{2ndIFout} = 4.092 \text{ MHz}$
- Integrated RF block : RF/IF frequency down-converter + PLL frequency synthesizer
- High-density surface mountable : 30-pin plastic SSOP (9.85 × 6.1 × 2.0 mm)
- Needless to input counter data : fixed division internal prescaler
 - VCO side division : ÷ 200 (÷ 25, ÷ 8 serial prescaler)
 - Reference division : ÷ 2
- Supply voltage : $V_{CC} = 2.7 \text{ to } 3.3 \text{ V}$
- Low current consumption : $I_{CC} = 45.0 \text{ mA TYP. @ } V_{CC} = 3.0 \text{ V}$
- Gain adjustable externally : Gain control voltage pin (control voltage up vs. gain down)

APPLICATION

- Consumer use GPS receiver of reference frequency 16.368 MHz, 2nd IF frequency 4.092 MHz

ORDERING INFORMATION

Part Number	Package	Supplying Form
μPB1005GS-E1	30-pin plastic SSOP (7.62 mm (300))	Embossed tape 16 mm wide. Pin 1 is in tape pull-out direction. QTY 2.5 kpcs/reel.

Remark To order evaluation samples, please contact your local NEC sales office. (Part number for sample order: μPB1005GS)

Caution Electro-static sensitive devices

The information in this document is subject to change without notice. Before using this document, please confirm that this is the latest version.

Not all devices/types available in every country. Please check with local NEC representative for availability and additional information.

PIN CONNECTIONS AND INTERNAL BLOCK DIAGRAM

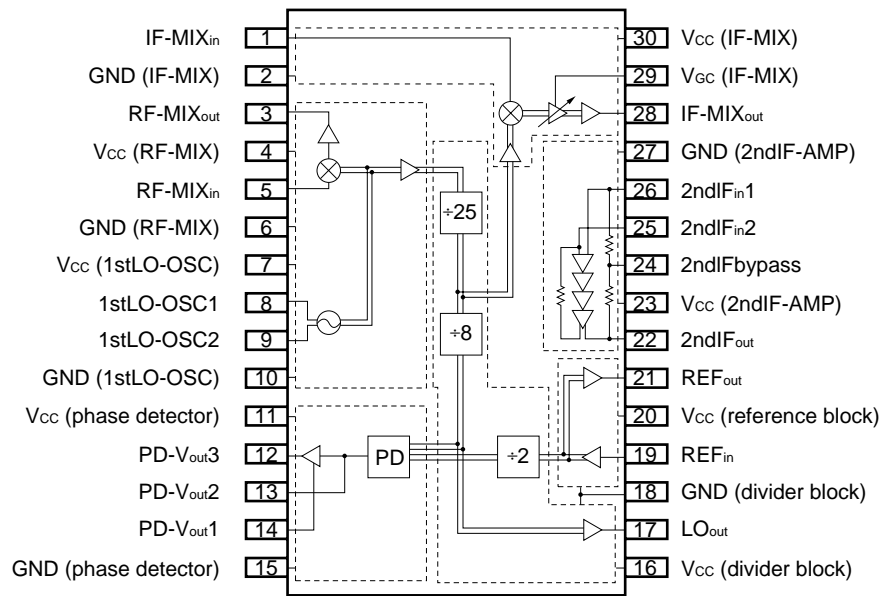

PRODUCT LINE-UP (T_A = +25°C, V_{CC} = 3.0 V)

Type	Part Number	Functions (Frequency unit: MHz)	V _{CC} (V)	I _{CC} (mA)	CG (dB)	T _A (°C)	Package	Status
General Purpose Wideband Separate IC	μPC2756T	RF down-converter with osc. Tr	2.7 to 3.3	6	14	-40 to +85	6-pin minimold	Available
	μPC2756TB						6-pin super minimold	
	μPC2753GR	IF down-converter with gain control amplifier	2.7 to 3.3	6.5	60 to 79	20-pin plastic SSOP		
Clock Frequency Specific 1 chip IC	μPB1003GS	RF/IF down-converter + PLL synthesizer REF = 18.414 1stIF = 28.644/2ndIF = 1.023	2.7 to 3.3	37.5	72 to 92	-20 to +85	30-pin plastic SSOP	Discontinued
	μPB1004GS	RF/IF down-converter + PLL synthesizer REF = 16.368	2.7 to 3.3	37.5	72 to 92	-20 to +85		
	μPB1005GS	1stIF = 61.380/2ndIF = 4.092	2.7 to 3.3	45.0	72 to 92	-40 to +85	Available	

Remark Typical performance. Please refer to ELECTRICAL CHARACTERISTICS in detail.
To know the associated products, please refer to their latest data sheets.

SYSTEM APPLICATION EXAMPLE

GPS receiver RF block diagram

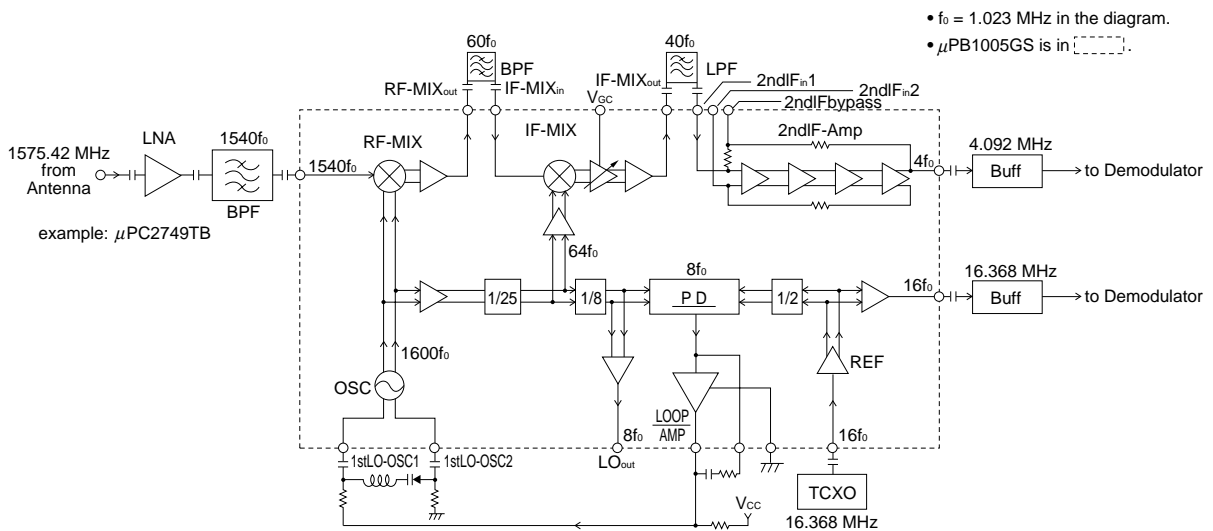

Caution This diagram schematically shows only the μPB1005GS's internal functions on the system. This diagram does not present the actual application circuits.

★ ABSOLUTE MAXIMUM RATINGS

Parameter	Symbol	Conditions	Ratings	Unit
Supply Voltage	V_{CC}	$T_A = +25^{\circ}\text{C}$	3.6	V
Total Circuit Current	I_{CC}	$T_A = +25^{\circ}\text{C}$	128	mA
Power Dissipation	P_D	Mounted on double-sided copper clad 50 × 50 × 1.6 mm epoxy glass PWB at $T_A = +85^{\circ}\text{C}$	464	mW
Operating Ambient Temperature	T_A		-40 to +85	°C
Storage Temperature	T_{stg}		-55 to +150	°C

RECOMMENDED OPERATING RANGE

Parameter	Symbol	MIN.	TYP.	MAX.	Unit
Supply Voltage	V_{CC}	2.7	3.0	3.3	V
Operating Ambient Temperature	T_A	-40	+25	+85	°C
RF Input Frequency	f_{RFIn}	—	1575.42	—	MHz
1stLO Oscillating Frequency	$f_{1stLOin}$	1616.80	1636.80	1656.80	MHz
1stIF Input Frequency	$f_{1stIFin}$	—	61.380	—	MHz
2ndLO Input Frequency	$f_{2ndLOin}$	—	65.472	—	MHz
2ndIF Input/output Frequency	$f_{2ndIFin}$ $f_{2ndIFout}$	—	4.092	—	MHz
Reference Input/output Frequency	f_{REFin} f_{REFout}	—	16.368	—	MHz

★ ELECTRICAL CHARACTERISTICS (Unless otherwise specified, T_A = +25°C, V_{CC} = 3.0 V)

Parameter	Symbol	Conditions	MIN.	TYP.	MAX.	Unit
Total Circuit Current	I _{ccTotal}	I _{cc1} + I _{cc2} + I _{cc3} + I _{cc4}	32.0	45.0	60.0	mA
RF Down-converter Block (f _{RFIn} = 1575.42 MHz, f _{1stLOin} = 1636.80 MHz, P _{LOin} = -10 dBm, Z _L = Z _S = 50 Ω)						
Circuit Current 1	I _{cc1}	No Signals	6.0	10.0	14.0	mA
RF Conversion Gain	CG _{RF}	P _{RFIn} = -40 dBm	12.5	15.5	18.5	dB
RF-SSB Noise Figure	NF _{RF}	P _{RFIn} = -40 dBm	7	10	13	dB
Maximum IF Output Power	P _{O(sat)RF}	P _{RFIn} = -10 dBm	-5.5	-2.5	+0.5	dBm
IF Down-converter Block (f _{1stIFin} = 61.38 MHz, f _{2ndLOin} = 65.472 MHz, Z _S = 50 Ω, Z _L = 2 kΩ)						
Circuit Current 2	I _{cc2}	No Signals	3.4	5.3	7.2	mA
IF Voltage Conversion Gain	CG _{(GV)IF}	at Maximum Gain, P _{1stIFin} = -50 dBm	38	41	44	dB
IF-SSB Noise Figure	NF _{IF}	at Maximum Gain, P _{1stIFin} = -50 dBm	8.5	11.5	14.5	dB
Maximum 2nd IF Output Power	P _{O(sat)IF}	at Maximum Gain, P _{1stIFin} = -20 dBm	-9.5	-6.5	-3.5	dBm
Gain Control Voltage	V _{GC}	Voltage at Maximum Gain of CG _{IF}	—	—	1.0	V
Gain Control Range	D _{GC}	P _{1stIFin} = -50 dBm	20	—	—	dB
2nd IF Amplifier (f _{2ndIF} = 4.092 MHz, Z _S = 50 Ω, Z _L = 2 kΩ)						
Circuit Current 3	I _{cc3}	No Signals	1.55	2.40	3.25	mA
Voltage Gain	G _V	P _{2ndIFin} = -60 dBm	37	40	43	dB
Maximum Output Power	P _{O(sat)}	P _{2ndIFin} = -30 dBm	-14.5	-11.5	-8.5	dBm
PLL Synthesizer Block						
Circuit Current 4	I _{cc4}	PLL All Block Operating	18.5	28.5	38.5	mA
Phase Comparing Frequency	f _{PD}	PLL Loop	8.0	8.184	8.4	MHz
Reference Input Minimum Level	V _{REFin}	Z _L = 10 kΩ//20 pF (Impedance of measurement equipment)	200	—	—	mV _{P-P}
Loop Filter Output Level (H)	V _{LP(H)}		2.8	—	—	V
Loop Filter Output Level (L)	V _{LP(L)}		—	—	0.4	V
Reference Output Swing	V _{REFout}	Z _L = 10 kΩ//2 pF (Impedance of measurement equipment)	1.0	—	—	V _{P-P}

STANDARD CHARACTERISTICS (Unless otherwise specified $T_A = +25^\circ\text{C}$, $V_{CC} = 3.0\text{ V}$)

Parameter	Symbol	Conditions	Reference	Unit
RF Down-converter Block ($P_{1stLOin} = -10\text{ dBm}$, $Z_L = Z_S = 50\ \Omega$)				
LO Leakage to IF Pin	LO _{if}	$f_{1stLOin} = 1636.80\text{ MHz}$	-30	dBm
LO Leakage to RF Pin	LO _{rf}	$f_{1stLOin} = 1636.80\text{ MHz}$	-30	dBm
Input 3rd Order Intercept Point	IIP _{3RF}	$f_{RFin1} = 1600\text{ MHz}$, $f_{RFin2} = 1605\text{ MHz}$ $f_{1stLOin} = 1660\text{ MHz}$	-13	dBm
IF Down-converter Block (1stLO oscillating, $Z_S = 50\ \Omega$, $Z_L = 2\text{ k}\Omega$)				
LO Leakage to 2nd IF Pin	LO _{2ndif}	$f_{2ndLOin} = 65.472\text{ MHz}$	-20	dBm
LO Leakage to 1st IF Pin	LO _{1stif}	$f_{2ndLOin} = 65.472\text{ MHz}$	-40	dBm
Input 3rd Order Intercept Point	IIP _{3IF}	$f_{1stIFin1} = 61.38\text{ MHz}$, $f_{1stIFin2} = 61.48\text{ MHz}$ $f_{2ndLOin} = 65.472\text{ MHz}$	-34	dBm

PIN EXPLANATION

Pin No.	Pin Name	Applied Voltage (V)	Pin Voltage (V)	Function and Application	Internal Equivalent Circuit
3	RX-MIX _{out}	—	1.68	Output pin of RF mixer. 1st IF filter must be inserted between pin 1 & 3.	
4	V _{cc} (RF-MIX)	2.7 to 3.3	—	Supply voltage pin of RF mixer block. This pin must be decoupled with capacitor (eg. 1 000 pF).	
5	RF-MIX _{in}	—	1.20	Input pin of RF mixer. 1 575.42 MHz band pass filter can be inserted between pin 5 and external LNA.	
6	GND (RF-MIX)	0	—	Ground pin RF mixer.	
7	V _{cc} (1stLO-OSC)	2.7 to 3.3	—	Supply voltage pin of differential amplifier for 1st LO oscillator circuit.	
8	1stLO-OSC1	—	1.88	Pin 8 & 9 are each base pin of differential amplifier for 1st LO oscillator. These pins should be equipped with LC and varactor to oscillate on 1636.80 MHz as VCO.	
9	1stLO-OSC2	—	1.88		
10	GND (1stLO-OSC)	0	—	Ground pin of differential amplifier for 1st LO oscillator circuit.	
11	V _{cc} (phase detector)	2.7 to 3.3	—	Supply voltage pin of phase detector and active loop filter.	
12	PD-V _{out3}	Pull-up with resistor	—	Pins of active loop filter for tuning voltage output. The active transistors configured with darlington pair are built on chip. Pin 14 should be pulled down with external resistor. Pin 12 to 13 should be equipped with external RC in order to adjust dumping factor and cutoff frequency. This tuning voltage output must be connected to varactor diode of 1st LO-OSC.	
13	PD-V _{out2}	—	Output in accordance with phase difference		
14	PD-V _{out1}	Pull-up with resistor	—		
15	GND (phase detector)	0	—	Ground pin of phase detector + active loop filter.	

Pin No.	Pin Name	Applied Voltage (V)	Pin Voltage (V)	Function and Application	Internal Equivalent Circuit
16	V _{CC} (divider block)	2.7 to 3.3	—	Supply voltage pin of prescalers.	
17	LO _{out}	—	2.08	Monitor pin of comparison frequency at phase detector.	
18	GND (divider block)	0	—	Ground pin of prescalers + LO _{out} amplifier	
19	REF _{in}	—	1.96	Input pin of reference frequency. This pin should be equipped with external 16.368 MHz oscillator (e.g. TCXO).	
20	V _{CC} (reference block)	2.7 to 3.3	—	Supply voltage pin of input/output amplifiers in reference block.	
21	REF _{out}	—	1.65	Output pin of reference frequency. The frequency from pin 19 can be taken out as 1 V _{P-P} swing.	
22	2ndIF _{out}	—	1.56	Output pin of 2nd IF amplifier. This pin output 4.092 MHz clipped sinewave. This pin should be equipped with external inverter to adjust level to next stage on user's system.	
23	V _{CC} (2ndIF-AMP)	2.7 to 3.3	—	Supply voltage pin of 2nd IF amplifier.	
24	2ndIF bypass	—	2.30	Bypass pin of 2nd IF amplifier input 1. This pin should be grounded through capacitor.	
25	2ndIF _{in2}	—	2.35	Pin of 2nd IF amplifier input 2. This pin should be grounded through capacitor.	
26	2ndIF _{in1}	—	2.35	Pin of 2nd IF amplifier input 1. 2nd IF filter can be inserted between pin 26 & 28.	
27	GND (2ndIF-AMP)	0	—	Ground pin of 2nd IF amplifier.	

Pin No.	Pin Name	Applied Voltage (V)	Pin Voltage (V)	Function and Application	Internal Equivalent Circuit
28	IF-MIX _{out}	—	1.15	Output pin from IF mixer. IF mixer output signal goes through gain control amplifier before this emitter follower output port.	
29	V _{GC} (IF-MIX)	0 to 3.3	—	Gain control voltage pin of IF mixer output amplifier. This voltage performs forward control (V _{GC} up → Gain down).	
30	V _{CC} (IF-MIX)	2.7 to 3.3	—	Supply voltage pin of IF mixer, gain control amplifier and emitter follower transistor.	
1	IF-MIX _{in}	—	2.05	Input pin of IF mixer.	
2	GND (IF-MIX)	0	—	Ground pin of IF mixer.	

Caution Ground pattern on the board must be formed as wide as possible to minimize ground impedance.

★ TYPICAL CHARACTERISTICS (Unless otherwise specified, $T_A = +25^\circ\text{C}$, $V_{CC} = 3.0\text{ V}$)

–IC TOTAL–

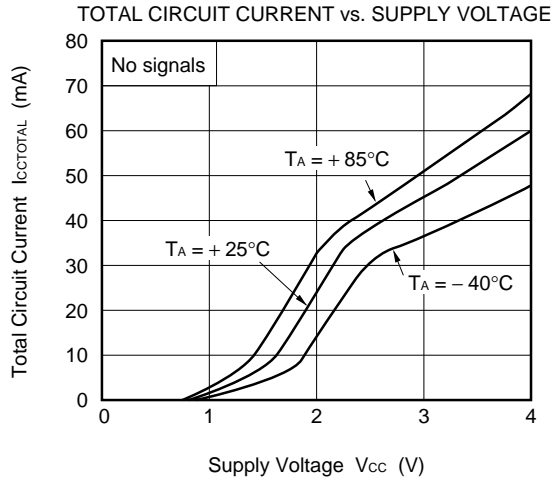

–RF DOWN-CONVERTER BLOCK–

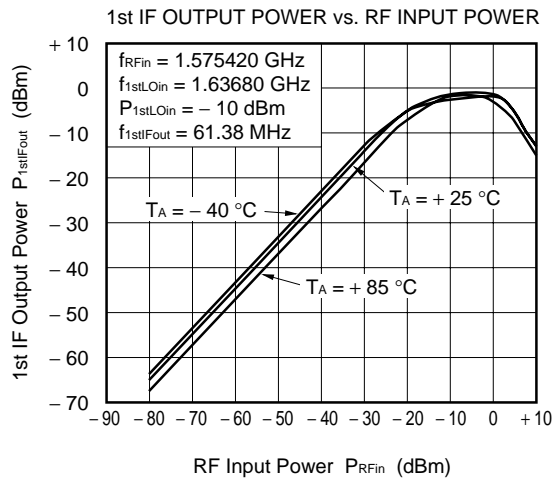
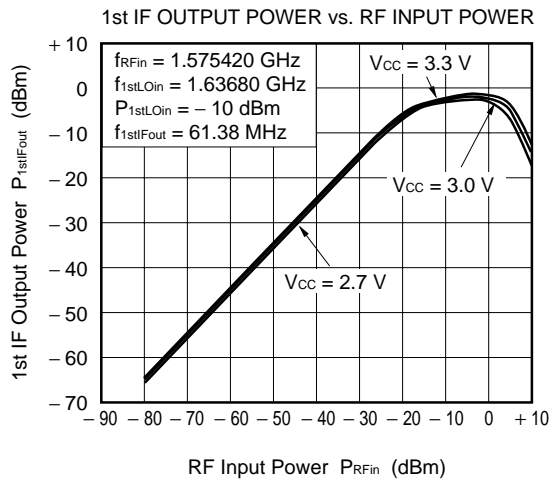
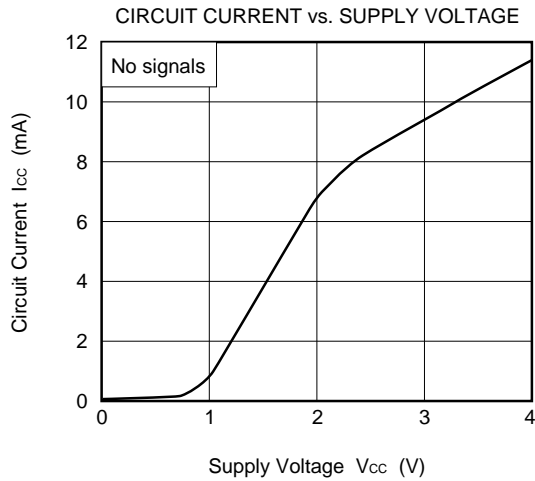

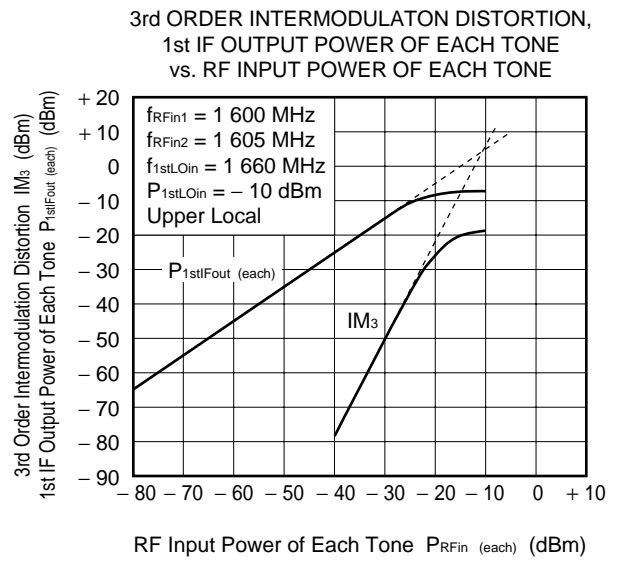
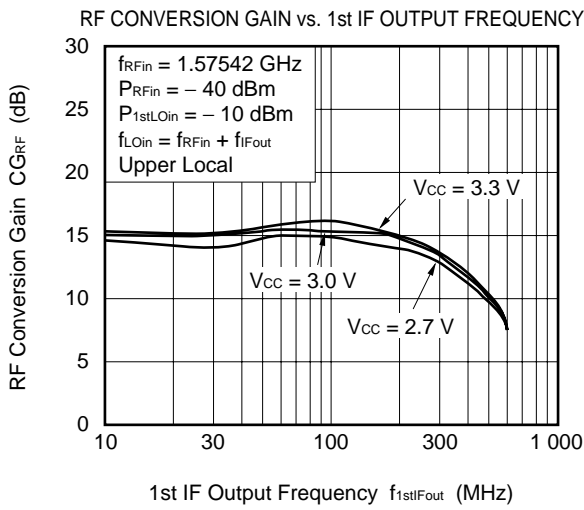
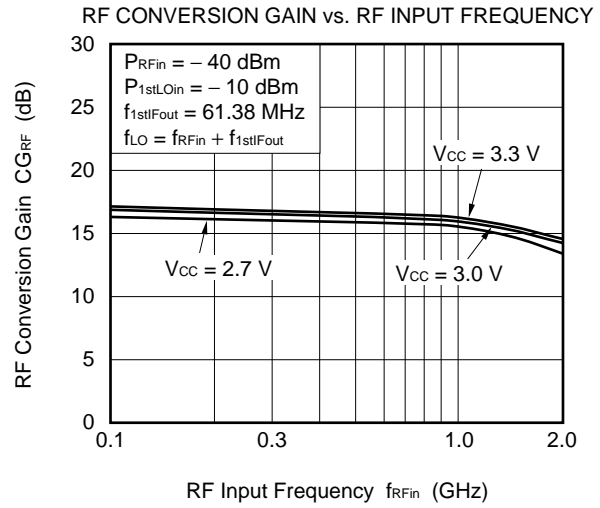
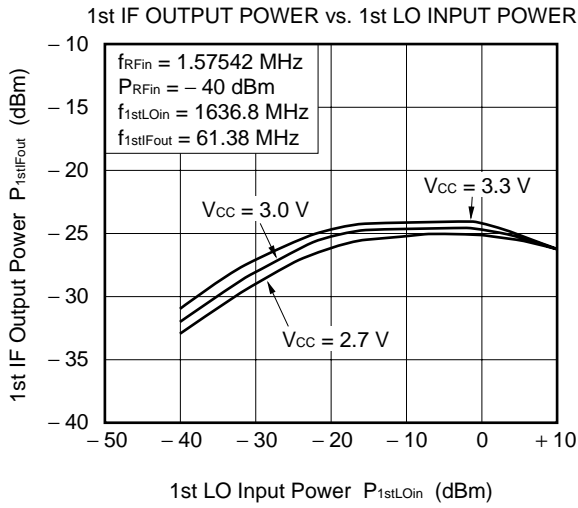

-IF DOWN-CONVERTER BLOCK-

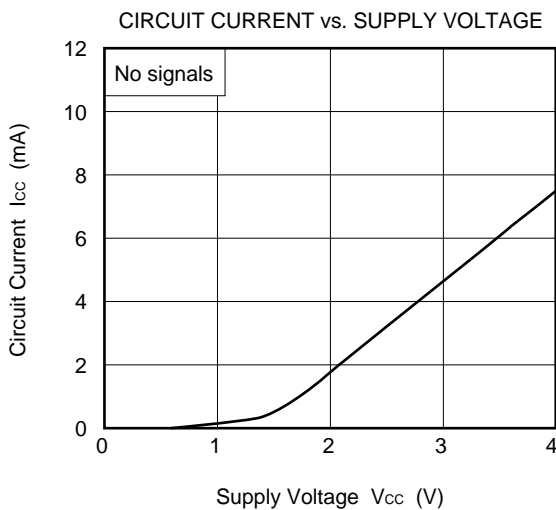

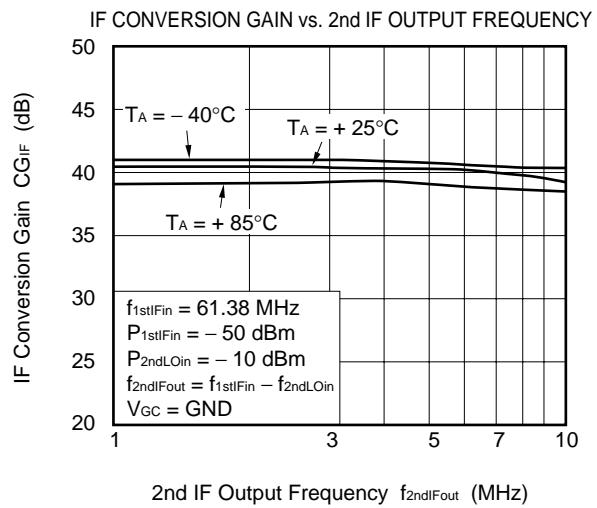
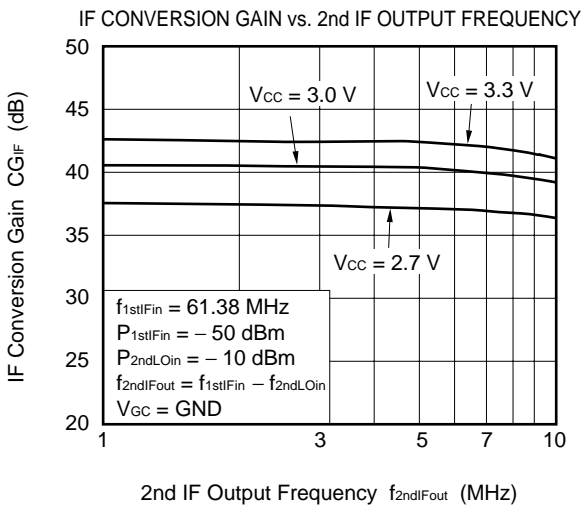
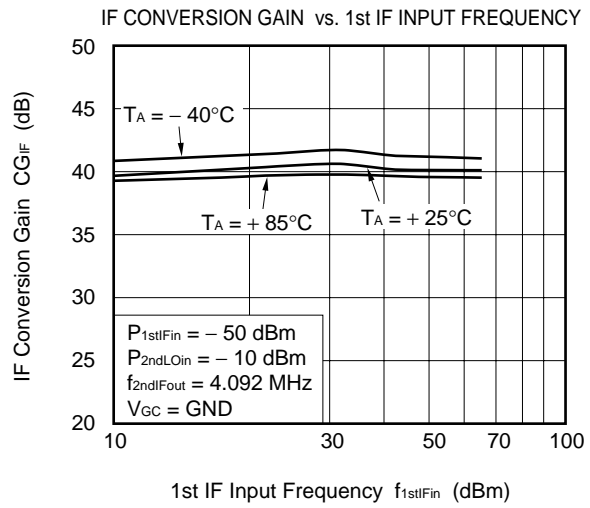
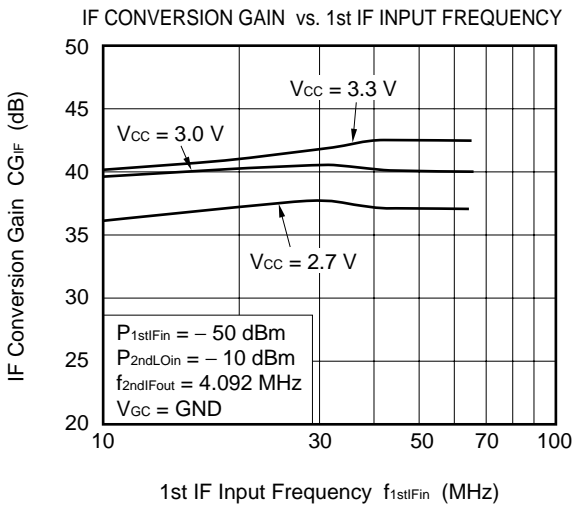
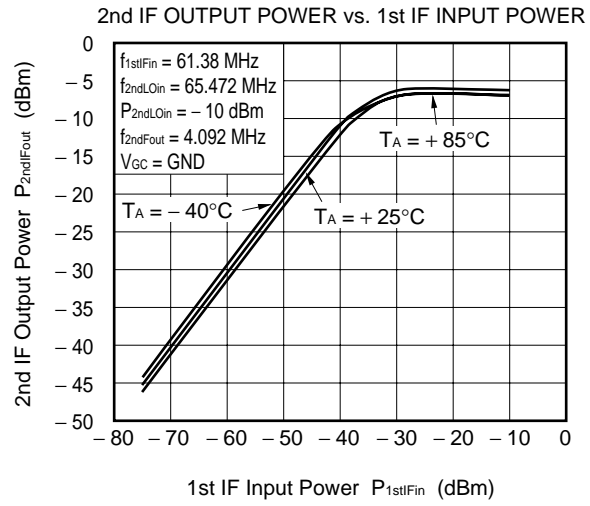
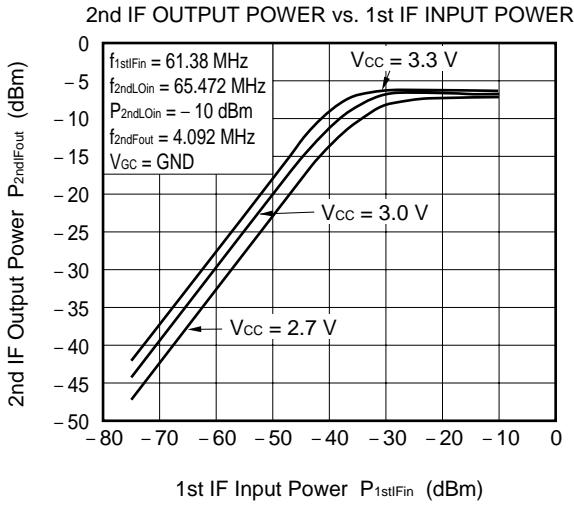

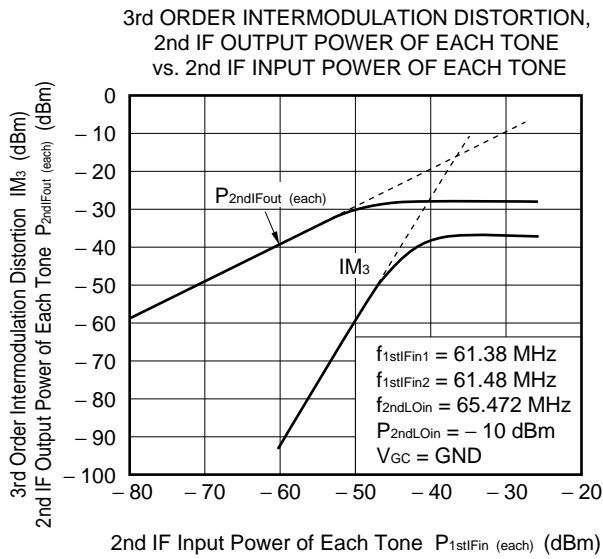
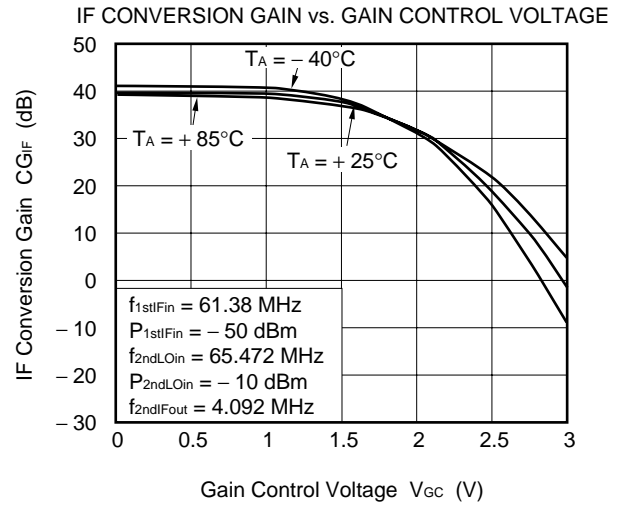
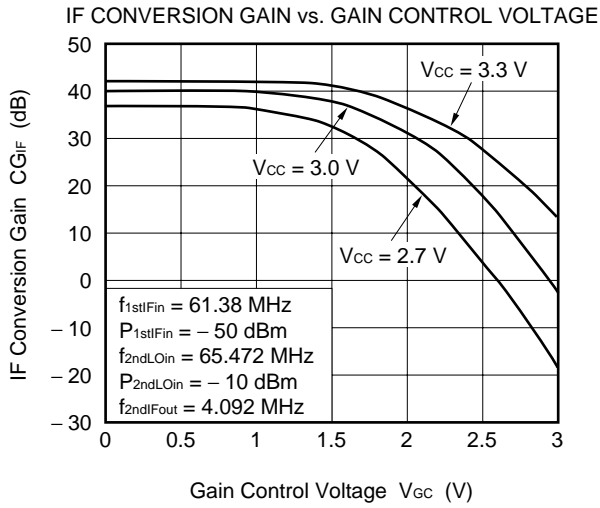

-IF AMPLIFIER BLOCK-

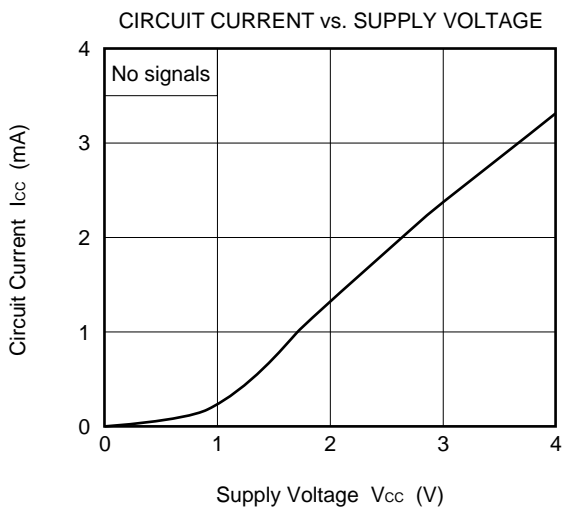

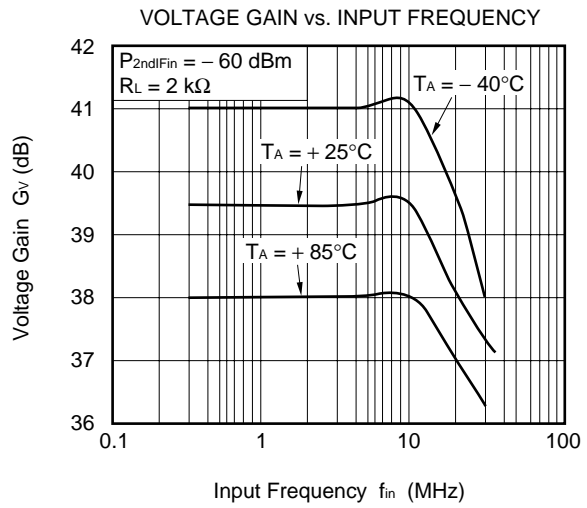
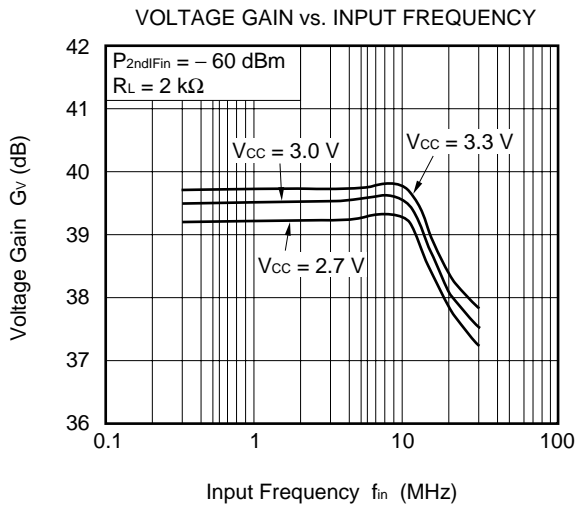
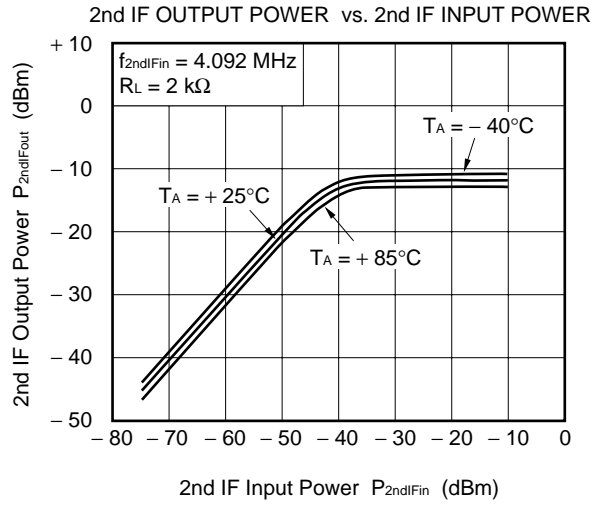
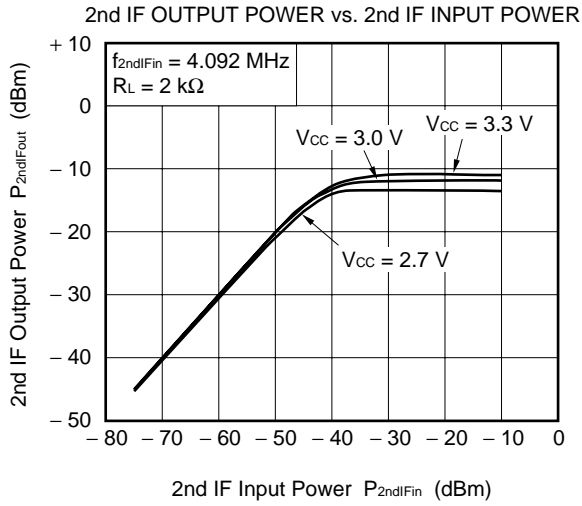

–PLL SYNTHESIZER BLOCK–

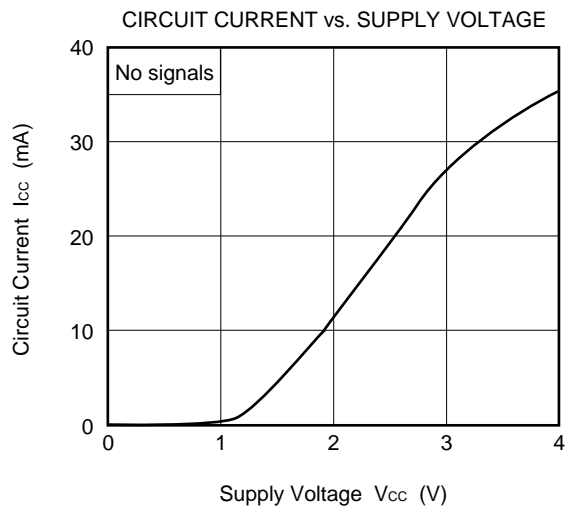

—REFERENCE BLOCK—

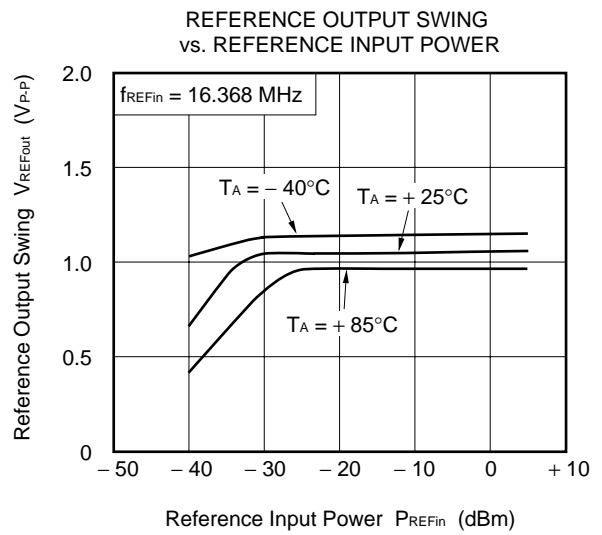
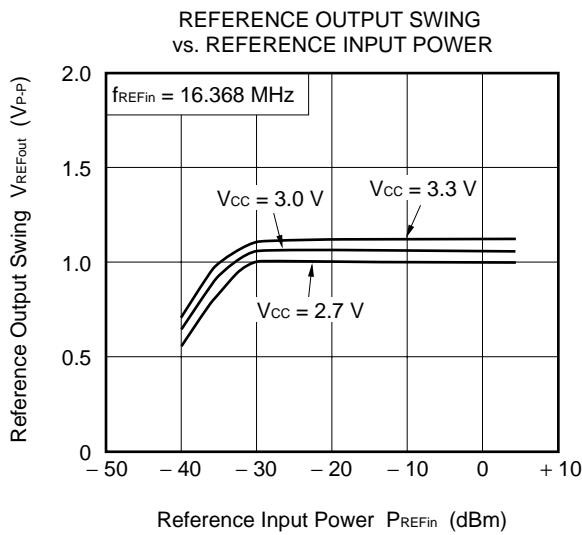
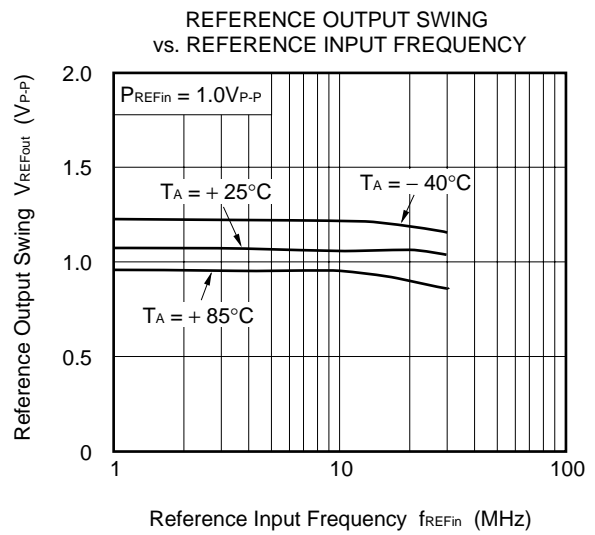
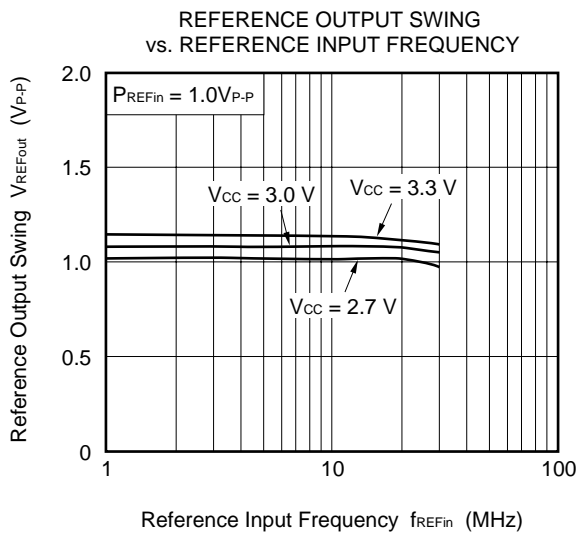

Remark The graphs indicate nominal characteristics.

TEST CIRCUIT

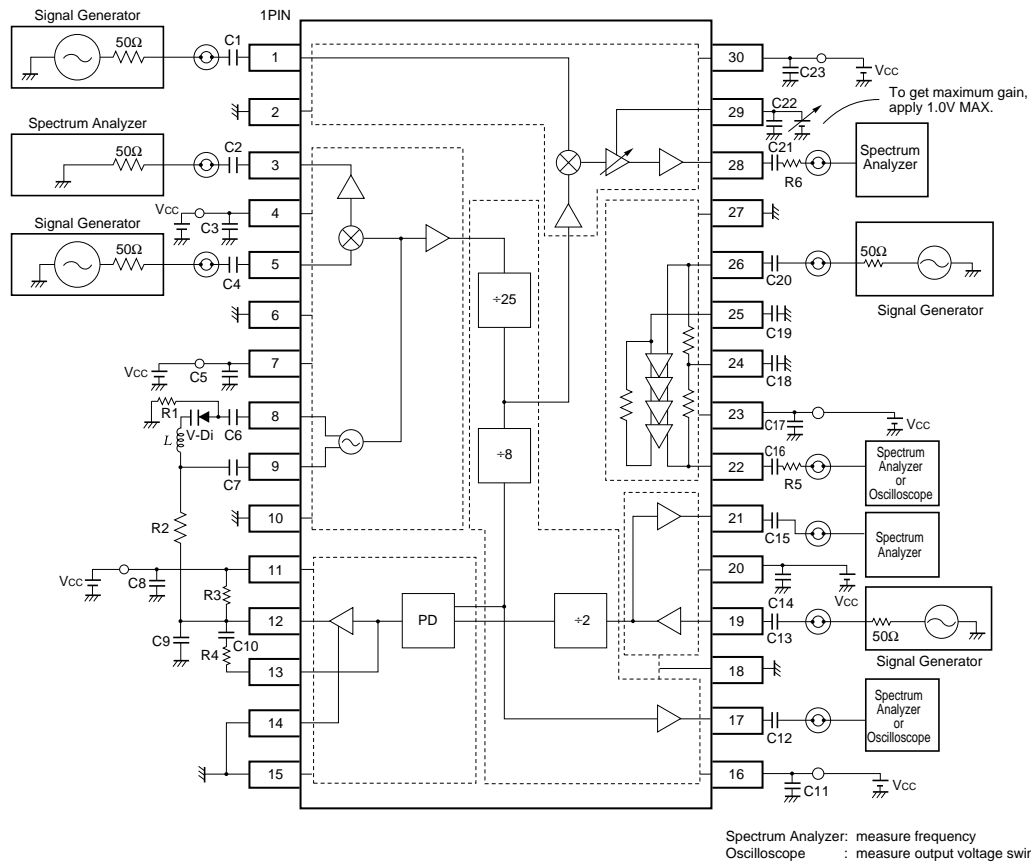

Component List

Form	Symbol	Value
Chip capacitor	C1 to C5, C8, C11 to C15, C17, C18, C22	1 000 pF
	C6, C7	24 pF (UJ)
	C9	1 800 pF
	C10	33 nF
	C19	10 000 pF
	C23	1 μF
Ceramic capacitor	C16, C20	0.1 μF
	C21	0.01 μF
Chip resistor	R1, R2	4.7 kΩ
	R3	6.2 kΩ
	R4	1.2 kΩ
	R5, R6	1.95 kΩ
Varactor Diode	V-Di	HVU12
Chip inductor	L	2.7 nH

PACKAGE DIMENSIONS

30 PIN PLASTIC SHRINK SOP (300 mil) (UNIT: mm)

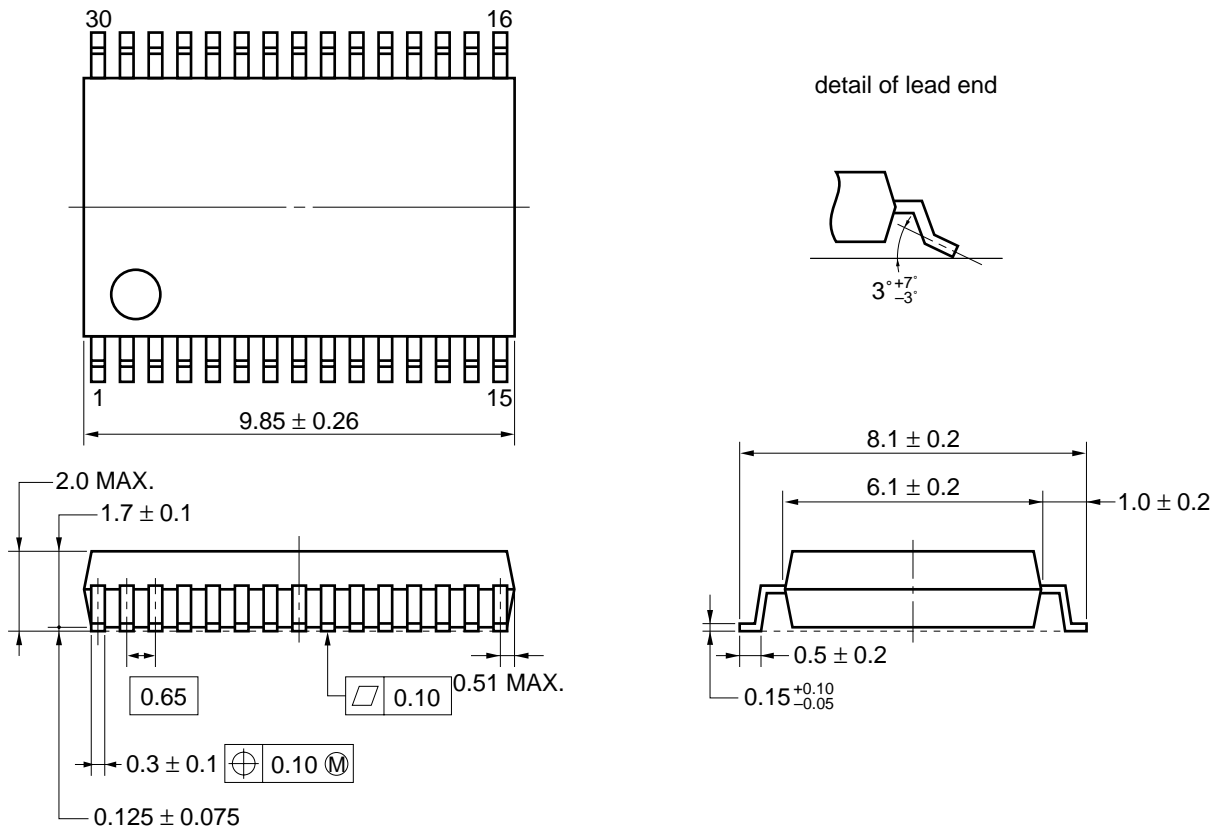

NOTE Each lead centerline is located within 0.10 mm of its true position (T.P.) at maximum material condition.

NOTE ON CORRECT USE

- (1) Observe precautions for handling because of electro-static sensitive devices.
- (2) Form a ground pattern as wide as possible to minimize ground impedance (to prevent abnormal oscillation).
- (3) Keep the track length of the ground pins as short as possible.
- (4) Connect a bypass capacitor (example: 1 000 pF) to the Vcc pin.
- (5) Frequency signal input/output pins must be each coupled with capacitor for DC cut.

RECOMMENDED SOLDERING CONDITIONS

This product should be soldered under the following recommended conditions. For soldering methods and conditions other than those recommended below, contact your NEC sales representative.

Soldering Method	Soldering Conditions	Recommended Condition Symbol
Infrared Reflow	Package peak temperature: 235°C or below Time: 30 seconds or less (at 210°C) Count: 3, Exposure limit: None ^{Note}	IR35-00-3
VPS	Package peak temperature: 215°C or below Time: 40 seconds or less (at 200°C) Count: 3, Exposure limit: None ^{Note}	VP15-00-3
Wave Soldering	Soldering bath temperature: 260°C or below Time: 10 seconds or less Count: 1, Exposure limit: None ^{Note}	WS60-00-1
Partial Heating	Pin temperature: 300°C Time: 3 seconds or less (per side of device) Exposure limit: None ^{Note}	—

Note After opening the dry pack, keep it in a place below 25°C and 65% RH for the allowable storage period.

Caution Do not use different soldering methods together (except for partial heating).

For details of recommended soldering conditions for surface mounting, refer to information document SEMICONDUCTOR DEVICE MOUNTING TECHNOLOGY MANUAL (C10535E).

[MEMO]

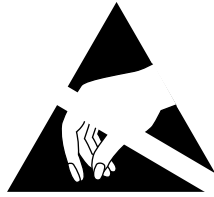

ATTENTION

OBSERVE PRECAUTIONS
FOR HANDLING
ELECTROSTATIC
SENSITIVE
DEVICES

NESAT (NEC Silicon Advanced Technology) is a trademark of NEC Corporation.

- **The information in this document is subject to change without notice. Before using this document, please confirm that this is the latest version.**
 - No part of this document may be copied or reproduced in any form or by any means without the prior written consent of NEC Corporation. NEC Corporation assumes no responsibility for any errors which may appear in this document.
 - NEC Corporation does not assume any liability for infringement of patents, copyrights or other intellectual property rights of third parties by or arising from use of a device described herein or any other liability arising from use of such device. No license, either express, implied or otherwise, is granted under any patents, copyrights or other intellectual property rights of NEC Corporation or others.
 - Descriptions of circuits, software, and other related information in this document are provided for illustrative purposes in semiconductor product operation and application examples. The incorporation of these circuits, software, and information in the design of the customer's equipment shall be done under the full responsibility of the customer. NEC Corporation assumes no responsibility for any losses incurred by the customer or third parties arising from the use of these circuits, software, and information.
 - While NEC Corporation has been making continuous effort to enhance the reliability of its semiconductor devices, the possibility of defects cannot be eliminated entirely. To minimize risks of damage or injury to persons or property arising from a defect in an NEC semiconductor device, customers must incorporate sufficient safety measures in its design, such as redundancy, fire-containment, and anti-failure features.
 - NEC devices are classified into the following three quality grades:
"Standard", "Special", and "Specific". The Specific quality grade applies only to devices developed based on a customer designated "quality assurance program" for a specific application. The recommended applications of a device depend on its quality grade, as indicated below. Customers must check the quality grade of each device before using it in a particular application.
 - Standard: Computers, office equipment, communications equipment, test and measurement equipment, audio and visual equipment, home electronic appliances, machine tools, personal electronic equipment and industrial robots
 - Special: Transportation equipment (automobiles, trains, ships, etc.), traffic control systems, anti-disaster systems, anti-crime systems, safety equipment and medical equipment (not specifically designed for life support)
 - Specific: Aircraft, aerospace equipment, submersible repeaters, nuclear reactor control systems, life support systems or medical equipment for life support, etc.
- The quality grade of NEC devices is "Standard" unless otherwise specified in NEC's Data Sheets or Data Books. If customers intend to use NEC devices for applications other than those specified for Standard quality grade, they should contact an NEC sales representative in advance.