

BIPOLAR ANALOG INTEGRATED CIRCUITS

μ PC2745TB, μ PC2746TB

3 V, SUPER MINIMOLD SILICON MMIC WIDEBAND AMPLIFIER FOR MOBILE COMMUNICATIONS

DESCRIPTION

The μ PC2745TB and μ PC2746TB are silicon monolithic integrated circuits designed as buffer amplifier for mobile communications. These ICs are packaged in super minimold package which is smaller than conventional minimold.

The μ PC2745TB and μ PC2746TB have each compatible pin connections and performance to μ PC2745T/ μ PC2746T of conventional minimold version. So, in the case of reducing your system size, μ PC2745TB/ μ PC2746TB are suitable to replace from μ PC2745T/ μ PC2746T.

These ICs are manufactured using NEC's 20 GHz fr NESAT™III silicon bipolar process. This process uses silicon nitride passivation film and gold electrodes. These materials can protect chip surface from external pollution and prevent corrosion/migration. Thus, these IC have excellent performance, uniformity and reliability.

FEATURES

- High-density surface mounting : 6 pin super minimold package
- Supply voltage : Recommended $V_{CC} = 2.7$ to 3.3 V
Circuit operation $V_{CC} = 1.8$ to 3.3 V
- Wideband response : $f_u = 2.7$ GHz_{TYP.} @ μ PC2745TB
 $f_u = 1.5$ GHz_{TYP.} @ μ PC2746TB
- High isolation : ISL = 38 dB_{TYP.} @ μ PC2745TB
ISL = 45 dB_{TYP.} @ μ PC2746TB

APPLICATION

- 1.5 GHz to 2.5 GHz communication system (PHS, wireless LAN; etc.): μ PC2745TB
- 800 MHz to 900 MHz cellular telephone (CT2, GSM, etc.) : μ PC2746TB

ORDERING INFORMATION

PART NUMBER	PACKAGE	MARKING	SUPPLYING FORM	f_u
μ PC2745TB-E3	6 pin super	C1Q	Embossed tape 8 mm wide. 1, 2, 3 pins face to perforation side of the tape. Qty 3 kp/reel.	2.7 GHz _{TYP.}
μ PC2746TB-E3	minimold	C1R		1.5 GHz _{TYP.}

Remarks To order evaluation samples, please contact your local NEC sales office.
(Part number: μ PC2745TB, μ PC2746TB)

Caution: Electro-static sensitive devices

PIN CONNECTIONS

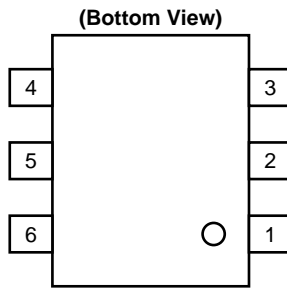
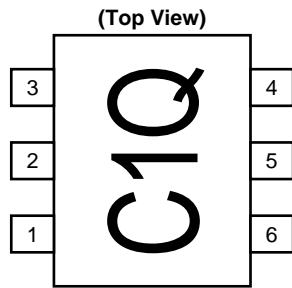

Pin NO.	Pin name
1	INPUT
2	GND
3	GND
4	OUTPUT
5	GND
6	V _{CC}

Marking is an example of μ PC2745TB

PRODUCT LINE-UP OF μ PC2745, μ PC2746 (T_A = +25 °C, V_{CC} = 3.0 V, Z_L = Z_s = 50 Ω)

PART NO.	f _u (GHz)	P _{O(sat)} (dBm)	G _P (dB)	NF (dB)	I _{CC} (mA)	PACKAGE	MARKING
μ PC2745T	2.7	-1	12	6.0	7.5	6 pin minimold	C1Q
μ PC2745TB						6 pin super minimold	
μ PC2746T	1.5	0	19	4.0	7.5	6 pin minimold	C1R
μ PC2746TB						6 pin super minimold	

Remarks Typical performance. Please refer to ELECTRICAL CHARACTERISTICS in detail.

Notice The package size distinguish between minimold and super minimold.

SYSTEM APPLICATION EXAMPLE

Digital Cellular System Block Diagram

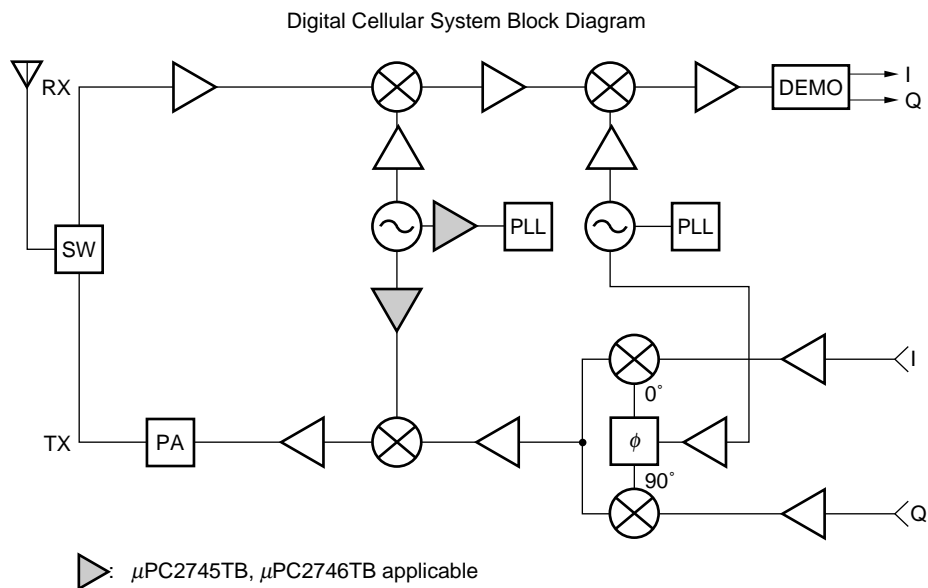

To know the associated products, please refer to each latest data sheet.

PIN EXPLANATION

Pin NO.	Pin Name	Applied voltage V	Pin voltage V ^{Note}	Function and applications	Internal equivalent circuit
1	INPUT	—	0.87 ----- 0.82	Signal input pin. A internal matching circuit, configured with resistors, enables 50 Ω connection over a wide band. this pin must be coupled to signal source with capacitor for DC cut.	
4	OUTPUT	—	1.95 ----- 2.54	Signal output pin. A internal matching circuit, configured with resistors, enables 50 Ω connection over a wide band. This pin must be coupled to next stage with capacitor for DC cut.	
6	V _{CC}	2.7 to 3.3	—	Power supply pin. This pin should be externally equipped with bypass capacity to minimize ground impedance.	
2 3 5	GND	0	—	Ground pin. This pin should be connected to system ground with minimum inductance. Ground pattern on the board should be formed as wide as possible. All the ground pins must be connected together with wide ground pattern to decrease impedance difference.	

Note Pin voltage is measured at V_{CC} = 3.0 V. Above: μPC2745TB, Below: μPC2746TB

ABSOLUTE MAXIMUM RATINGS

PARAMETER	SYMBOL	CONDITION	RATINGS	UNIT
Supply voltage	V _{CC}	T _A = +25 °C	4.0	V
Circuit current	I _{CC}	T _A = +25 °C	16	mA
Input power level	P _{in}	T _A = +25 °C	0	dBm
Total power dissipation	P _D	Mounted on double sided copper clad 50 × 50 × 1.6 mm epoxy glass PWB (T _A = +85 °C)	200	mW
Operating ambient temperature	T _A		-40 to +85	°C
Storage temperature	T _{STG}		-55 to +150	°C

RECOMMENDED OPERATING CONDITIONS

PARAMETER	SYMBOL	MIN.	TYP.	MAX.	UNIT	NOTICE
Supply voltage	V _{CC}	2.7	3.0	3.3	V	
Operating ambient temperature	T _A	-40	+25	+85	°C	

ELECTRICAL CHARACTERISTICS (T_A = + 25 °C, V_{CC} = 3.0 V, Z_L = Z_s = 50 Ω)

PARAMETER	SYMBOL	TEST CONDITION	μ PC2745TB			μ PC2746TB			UNIT
			MIN.	TYP.	MAX.	MIN.	TYP.	MAX.	
Circuit current	I _{CC}	No signals	5.0	7.5	10.0	5.0	7.5	10.0	mA
Power Gain	G _P	f = 0.5 GHz	9.0	12	14	16	19	21	dB
Noise figure	NF	f = 0.5 GHz	—	6	7.5	—	4.0	5.5	dB
Upper limit operating frequency	f _u	3 dB down below from gain at f = 100 MHz	2.3	2.7	—	1.1	1.5	—	GHz
Isolation	ISL	f = 0.5 GHz	33	38	—	40	45	—	dB
Input return loss	RL _{in}	f = 0.5 GHz	8	11	—	10	13	—	dB
Output return loss	RL _{out}	f = 0.5 GHz	2.5	5.5	—	5.5	8.5	—	dB
Maximum output level	P _{O(sat)}	f = 0.5 GHz, P _{in} = -6 dBm	-4	-1	—	-3	0	—	dBm

STANDARD CHARACTERISTICS FOR REFERENCE ($T_A = +25\text{ }^\circ\text{C}$, $V_{CC} = 3.0\text{ V}$, $Z_L = Z_S = 50\ \Omega$)

PARAMETER	SYMBOL	TEST CONDITION	μ PC2745TB	μ PC2745B	UNIT
Circuit current	I_{CC}	$V_{CC} = 1.8\text{ V}$, No signals	4.5	4.5	mA
Power Gain	G_P	$V_{CC} = 3.0\text{ V}$, $f = 1\text{ GHz}$	12	18.5	dB
		$V_{CC} = 3.0\text{ V}$, $f = 2\text{ GHz}$	11	—	
		$V_{CC} = 1.8\text{ V}$, $f = 500\text{ MHz}$	7	14	
Noise figure	NF	$V_{CC} = 3.0\text{ V}$, $f = 1\text{ GHz}$	5.5	4.2	dB
		$V_{CC} = 3.0\text{ V}$, $f = 2\text{ GHz}$	5.7	—	
		$V_{CC} = 1.8\text{ V}$, $f = 500\text{ MHz}$	8.0	5.0	
Upper limit operating frequency	f_u	$V_{CC} = 1.8\text{ V}$, 3 dB down below from gain at $f = 100\text{ MHz}$	1.8	1.1	GHz
Isolation	ISL	$V_{CC} = 3.0\text{ V}$, $f = 1\text{ GHz}$	33	38	dB
		$V_{CC} = 3.0\text{ V}$, $f = 2\text{ GHz}$	30	—	
		$V_{CC} = 1.8\text{ V}$, $f = 500\text{ MHz}$	35	37	
Input return loss	RL_{in}	$V_{CC} = 3.0\text{ V}$, $f = 1\text{ GHz}$	13	10	dB
		$V_{CC} = 3.0\text{ V}$, $f = 2\text{ GHz}$	14	—	
		$V_{CC} = 1.8\text{ V}$, $f = 500\text{ MHz}$	6.5	10	
Output return loss	RL_{out}	$V_{CC} = 3.0\text{ V}$, $f = 1\text{ GHz}$	6.5	8.5	dB
		$V_{CC} = 3.0\text{ V}$, $f = 2\text{ GHz}$	8.5	—	
		$V_{CC} = 1.8\text{ V}$, $f = 500\text{ MHz}$	6.0	9.5	
Maximum output level	$P_{O(sat)}$	$V_{CC} = 3.0\text{ V}$, $f = 1\text{ GHz}$, $P_{in} = -6\text{ dBm}$	-2.5	-1	dBm
		$V_{CC} = 3.0\text{ V}$, $f = 2\text{ GHz}$, $P_{in} = -6\text{ dBm}$	-3.5	—	
		$V_{CC} = 1.8\text{ V}$, $f = 500\text{ MHz}$, $P_{in} = -10\text{ dBm}$	-11	-8	
3rd order intermodulation distortion	IM_3	$V_{CC} = 3.0\text{ V}$, $P_{out} = -20\text{ dBm}$, $f_1 = 500\text{ MHz}$, $f_2 = 502\text{ MHz}$	-54	-51	dBc
		$V_{CC} = 3.0\text{ V}$, $P_{out} = -20\text{ dBm}$, $f_1 = 1\ 000\text{ MHz}$, $f_2 = 1\ 002\text{ MHz}$	-50	—	
		$V_{CC} = 1.8\text{ V}$, $P_{out} = -20\text{ dBm}$, $f_1 = 500\text{ MHz}$, $f_2 = 502\text{ MHz}$	-31	-37	

TEST CIRCUIT

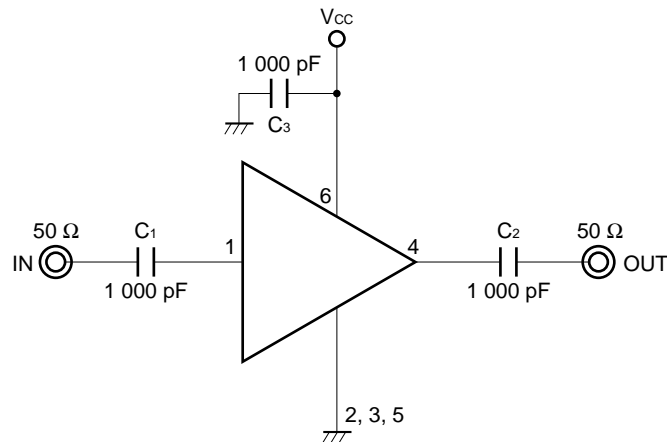

EXAMPLE OF APPLICATION CIRCUIT

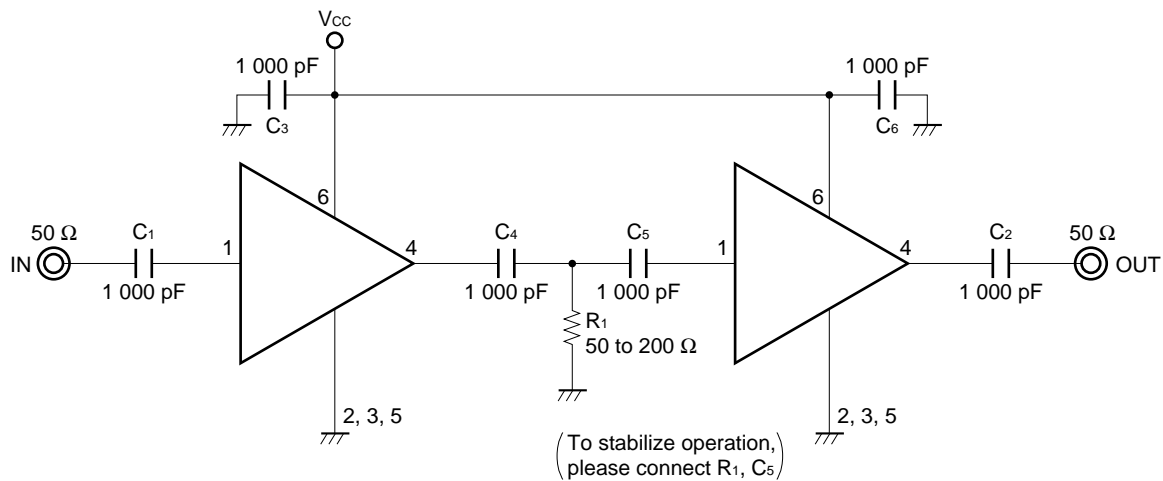

The application circuits and their parameters are for references only and are not intended for use in actual design-in's.

Capacitors for Vcc, input and output pins

1 000 pF capacitors are recommendable as bypass capacitor for Vcc pin and coupling capacitors for input/output pins.

Bypass capacitor for Vcc pin is intended to minimize Vcc pin's ground impedance. Therefore, stable bias can be supplied against Vcc fluctuation.

Coupling capacitors for input/output pins are intended to minimize RF serial impedance and cut DC.

To get flat gain from 100 MHz up, 1 000 pF capacitors are assembled on the test circuit. [Actually, 1 000 pF capacitors give flat gain at least 10 MHz. In the case of under 10 MHz operation, increase the value of coupling capacitor such as 2 200 pF. Because the coupling capacitors are determined by the equation of $C = 1/(2 \pi fZ_s)$.]

Illustration of the test circuit assembled on evaluation board

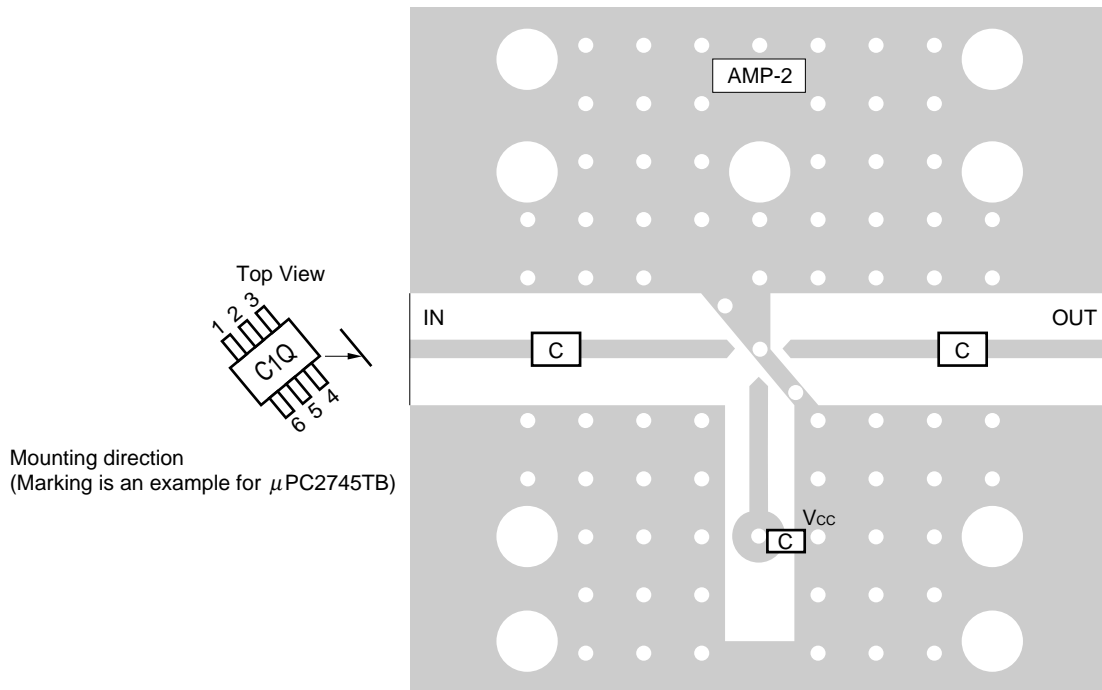

Component List

	Value
C	1 000 pF

Notes

1. 30 × 30 × 0.4 mm double sided copper clad polyimide board.
2. Back side: GND pattern
3. Solder plated on pattern
4. $\oplus\oplus\oplus$: Through holes

TYPICAL CHARACTERISTICS (Unless otherwise specified, $T_A = +25\text{ }^\circ\text{C}$)

— μ PC2745TB —

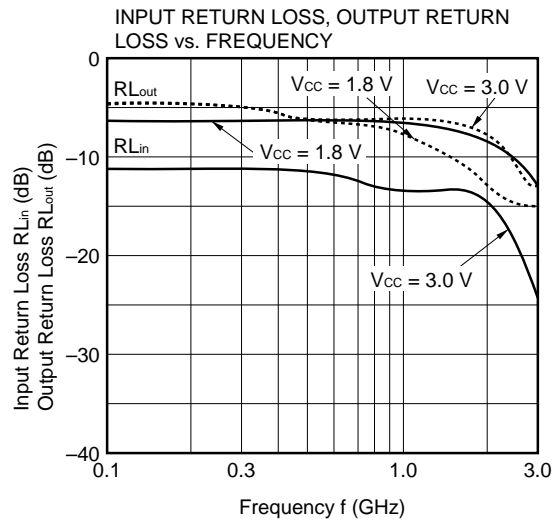
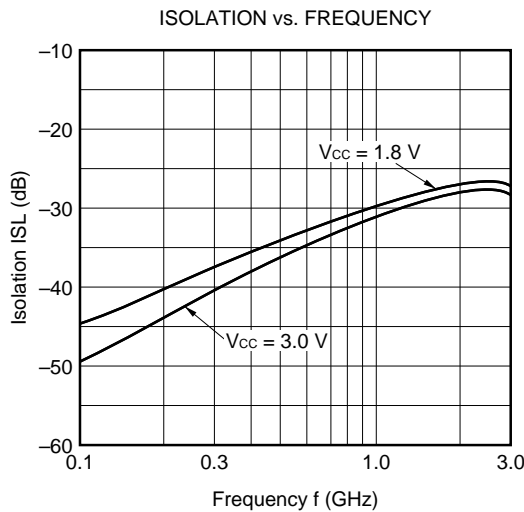
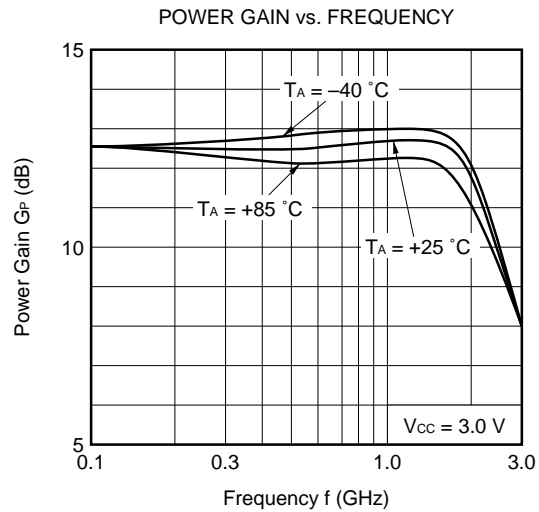
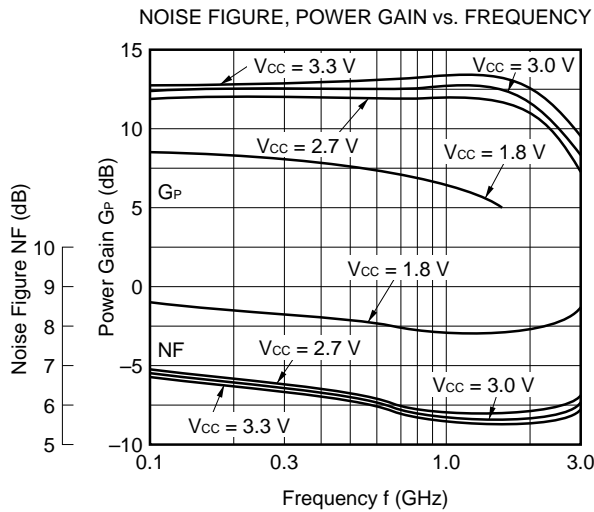
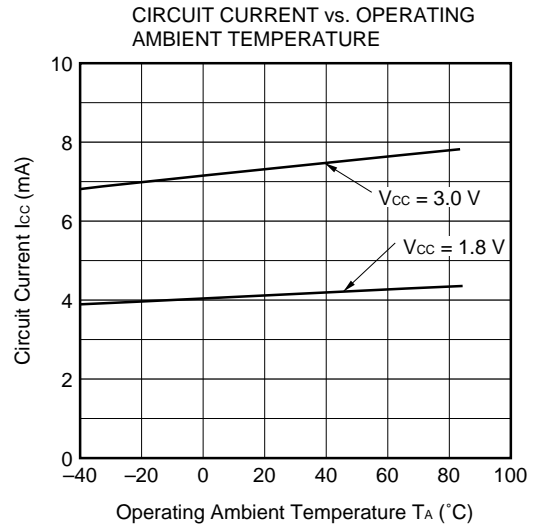
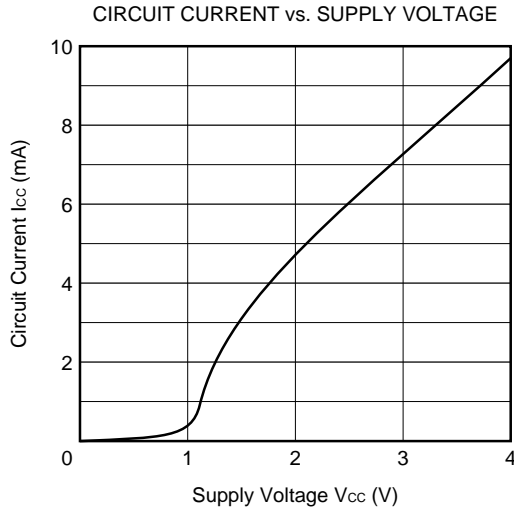

— μ PC2745TB —

OUTPUT POWER vs. INPUT POWER

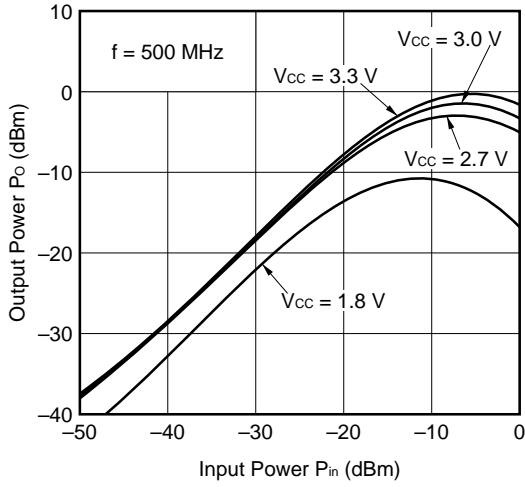

OUTPUT POWER vs. INPUT POWER

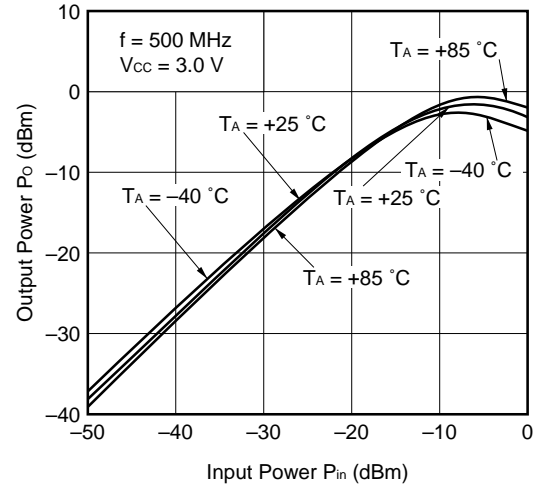

OUTPUT POWER vs. INPUT POWER

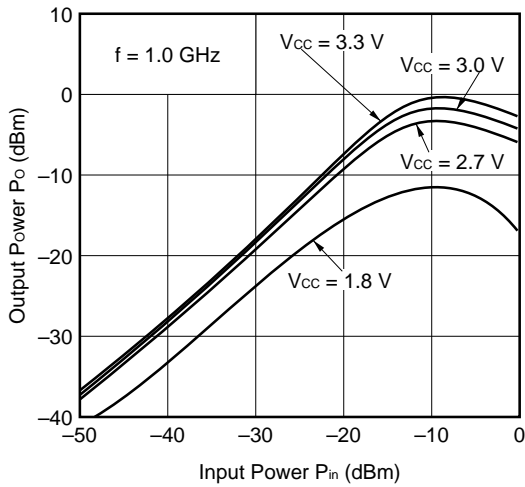

OUTPUT POWER vs. INPUT POWER

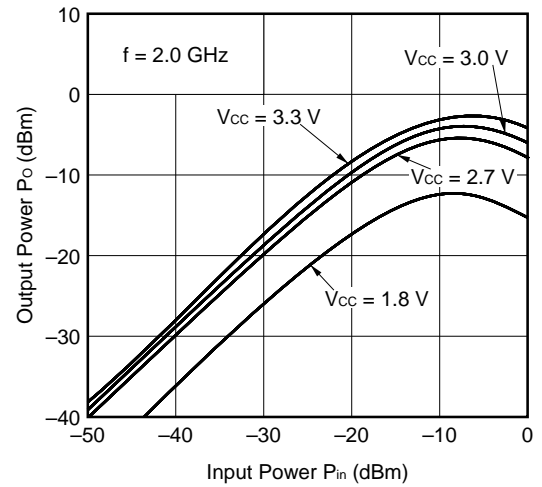

SATURATED OUTPUT POWER vs. FREQUENCY

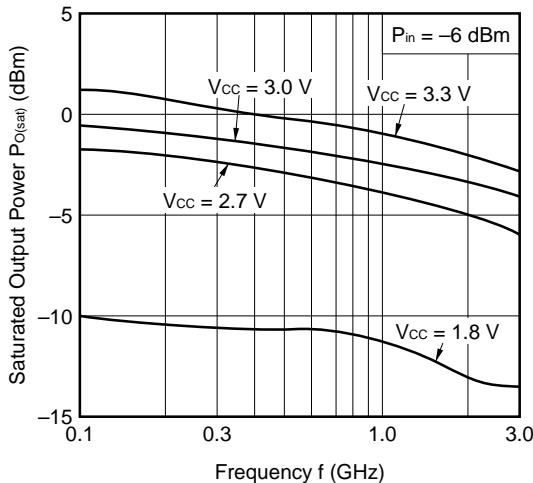

3RD ORDER INTERMODULATION DISTORTION vs. OUTPUT POWER OF EACH TONE

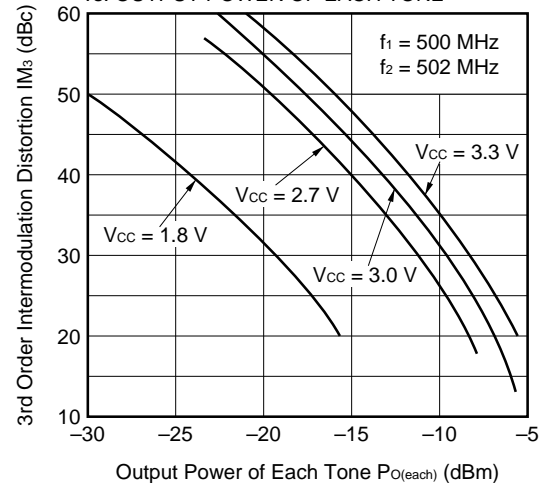

S Parameter ($V_{cc} = 3.0\text{ V}$)

— μ PC2745TB —

S₁₁-FREQUENCY

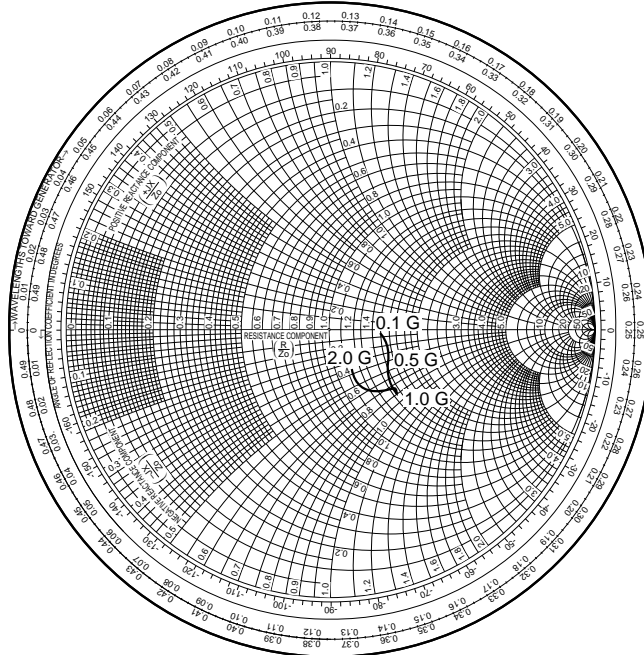

S₂₂-FREQUENCY

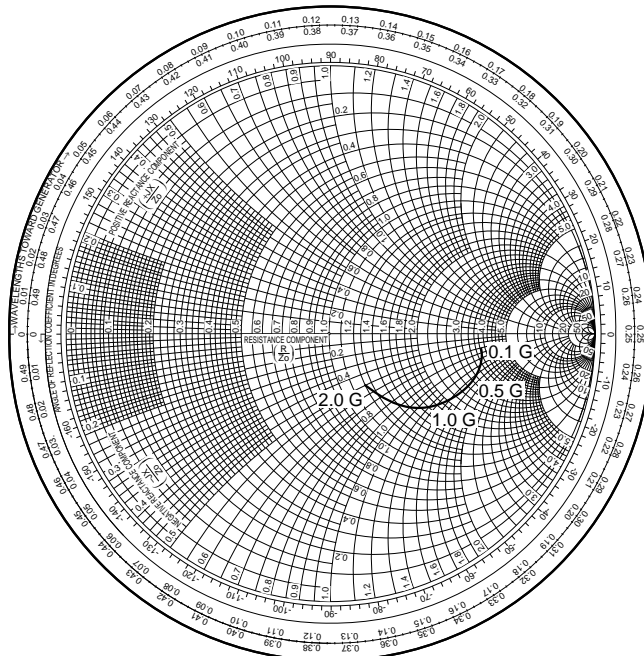

Typical S Parameter Values (T_A = +25 °C)

μPC2745TB

V_{CC} = 3.0 V, I_{CC} = 8.4 mA

FREQUENCY MHz	S11		S21		S12		S22		K
	MAG	ANG	MAG	ANG	MAG	ANG	MAG	ANG	
100.0000	.318	-3.9	4.055	-17.2	.003	62.9	.593	-6.6	20.94
200.0000	.325	-5.9	4.030	-35.5	.006	54.2	.584	-12.1	11.68
300.0000	.346	-7.2	3.985	-52.5	.009	42.0	.579	-16.5	8.29
400.0000	.341	-8.9	3.916	-70.7	.012	29.4	.562	-20.6	6.26
500.0000	.339	-10.8	3.842	-87.3	.013	11.8	.546	-23.0	6.29
600.0000	.326	-13.9	3.775	-104.7	.015	1.6	.527	-26.2	5.50
700.0000	.311	-20.8	3.668	-121.5	.017	-11.9	.515	-29.9	5.46
800.0000	.312	-25.8	3.594	-138.1	.018	-24.2	.511	-32.4	5.36
900.0000	.325	-31.9	3.525	-154.2	.020	-38.4	.512	-34.8	4.91
1000.0000	.356	-32.8	3.497	-170.3	.019	-45.9	.523	-35.8	4.93
1100.0000	.382	-32.7	3.503	173.7	.020	-54.3	.525	-36.3	4.56
1200.0000	.416	-31.2	3.542	156.7	.022	-70.5	.530	-36.8	4.14
1300.0000	.416	-30.9	3.569	139.1	.023	-78.4	.518	-37.5	3.92
1400.0000	.415	-30.8	3.520	121.4	.025	-88.4	.509	-38.8	3.53
1500.0000	.393	-30.3	3.501	103.7	.025	-102.9	.492	-40.5	3.68
1600.0000	.386	-31.3	3.429	86.8	.025	-114.1	.481	-42.5	3.78
1700.0000	.373	-30.5	3.355	69.7	.026	-125.7	.474	-43.8	3.68
1800.0000	.369	-31.6	3.303	52.7	.028	-130.3	.468	-44.8	3.50
1900.0000	.366	-29.6	3.229	35.8	.028	-142.5	.457	-44.8	3.63
2000.0000	.353	-30.0	3.179	18.8	.030	-152.4	.440	-45.0	3.62
2100.0000	.344	-28.6	3.081	1.5	.031	-164.9	.416	-45.0	3.85
2200.0000	.313	-29.5	2.999	-15.4	.031	-177.1	.389	-45.4	4.23
2300.0000	.293	-31.6	2.911	-32.5	.033	171.1	.365	-46.4	4.23
2400.0000	.267	-35.1	2.802	-49.4	.034	160.8	.346	-47.4	4.40
2500.0000	.262	-39.9	2.695	-66.0	.036	148.3	.331	-48.2	4.45
2600.0000	.253	-40.3	2.598	-82.3	.036	134.8	.321	-48.3	4.54
2700.0000	.253	-40.9	2.496	-98.6	.034	121.4	.311	-47.6	5.08
2800.0000	.248	-35.5	2.400	-114.6	.036	106.5	.299	-46.7	5.01
2900.0000	.237	-30.2	2.306	-130.2	.032	92.8	.279	-46.3	5.88
3000.0000	.230	-20.6	2.209	-146.4	.031	83.6	.254	-46.2	6.49

TYPICAL CHARACTERISTICS (Unless otherwise specified, $T_A = +25\text{ }^\circ\text{C}$)

— μ PC2746TB —

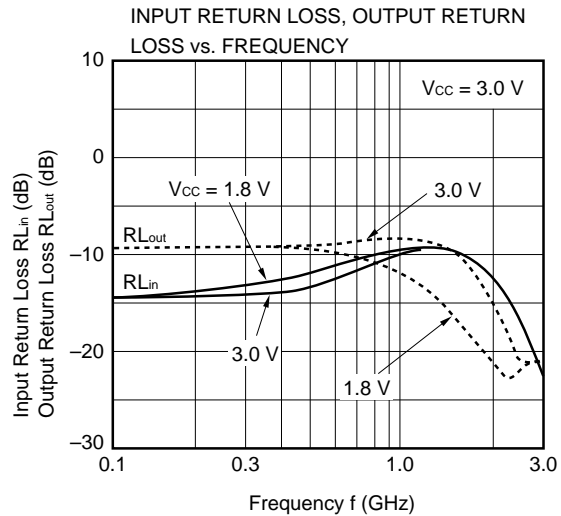
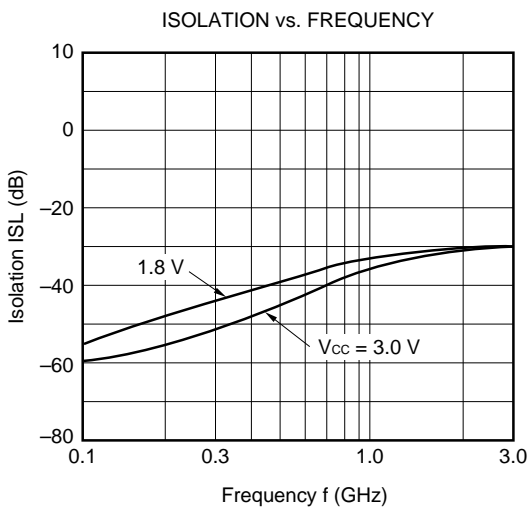
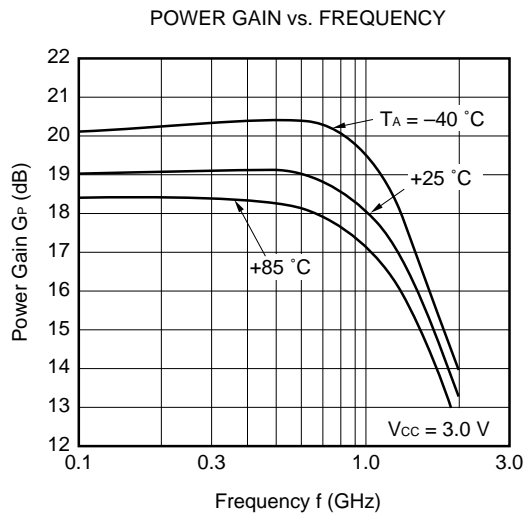
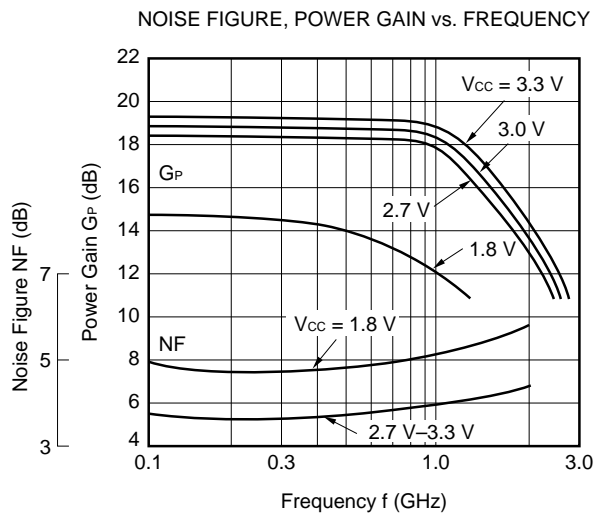
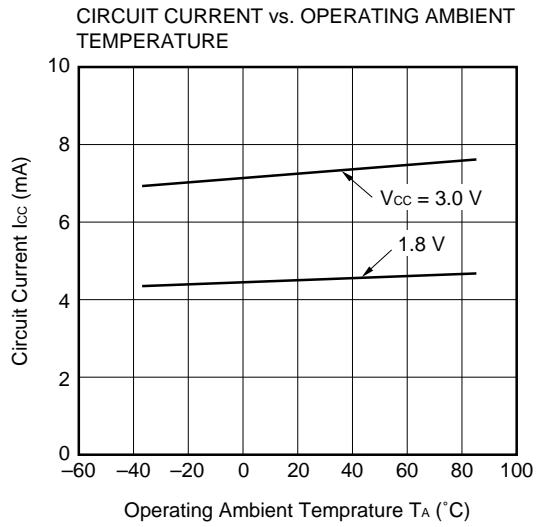
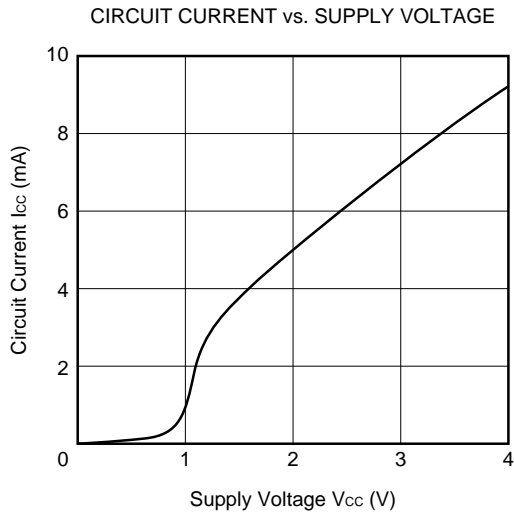

— μ PC2746TB —

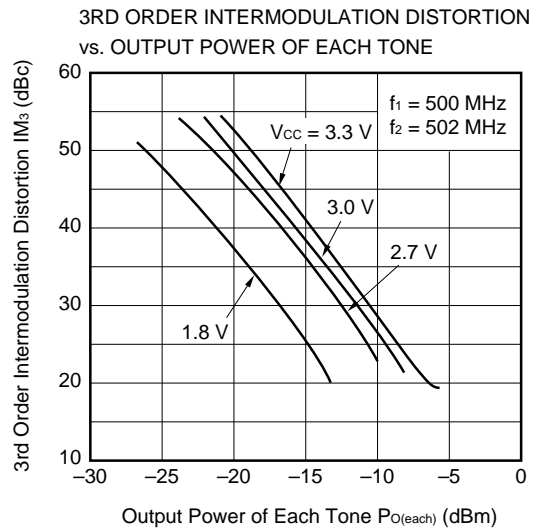
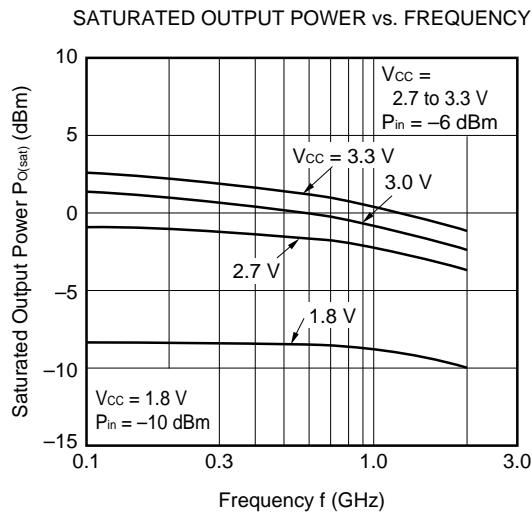
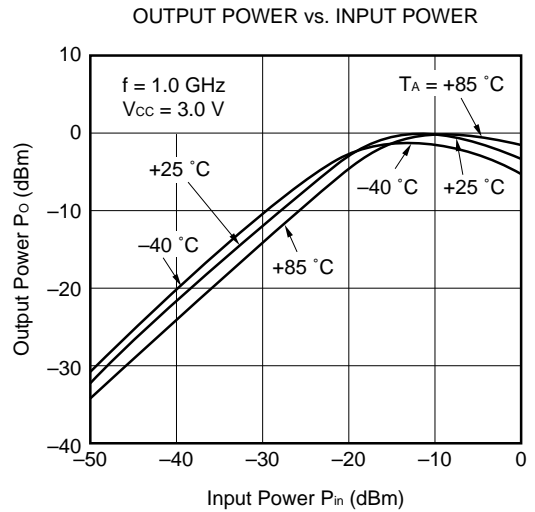
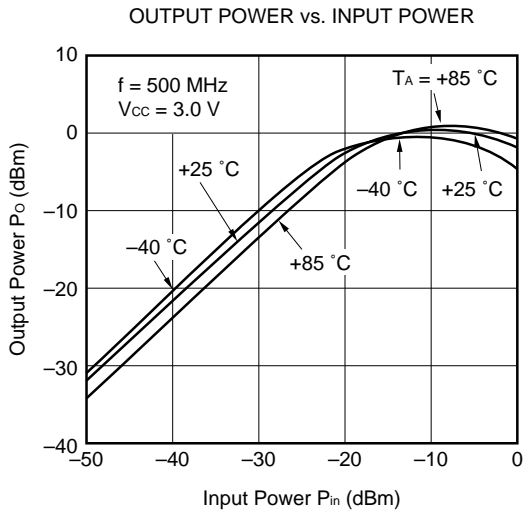
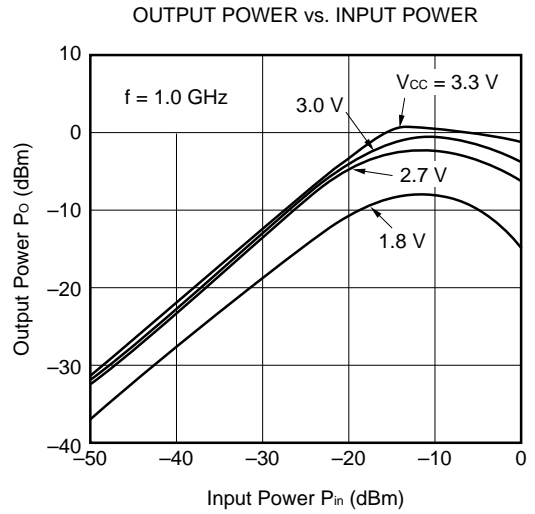
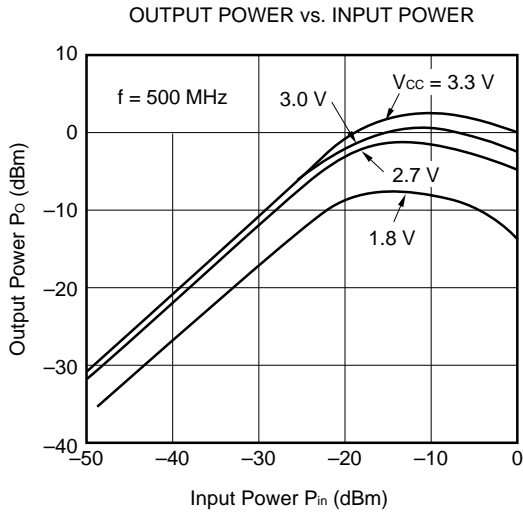

S Parameter ($V_{cc} = 3.0\text{ V}$)

— μ PC2746TB —

S₁₁-FREQUENCY

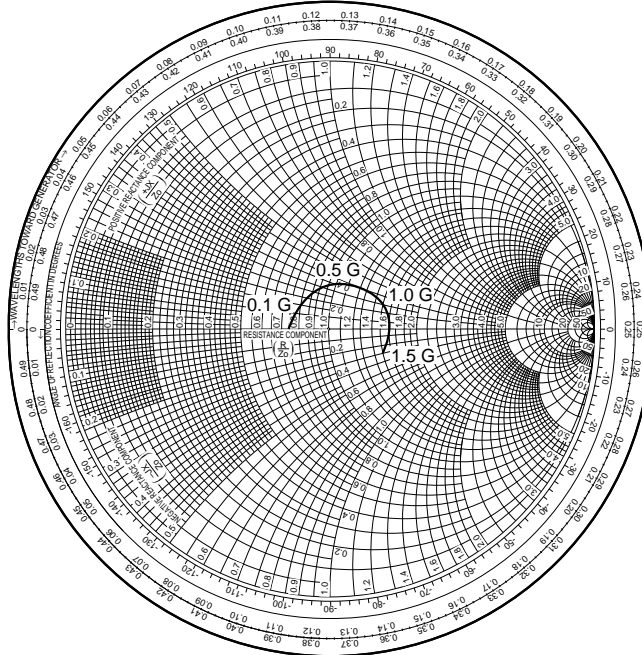

S₂₂-FREQUENCY

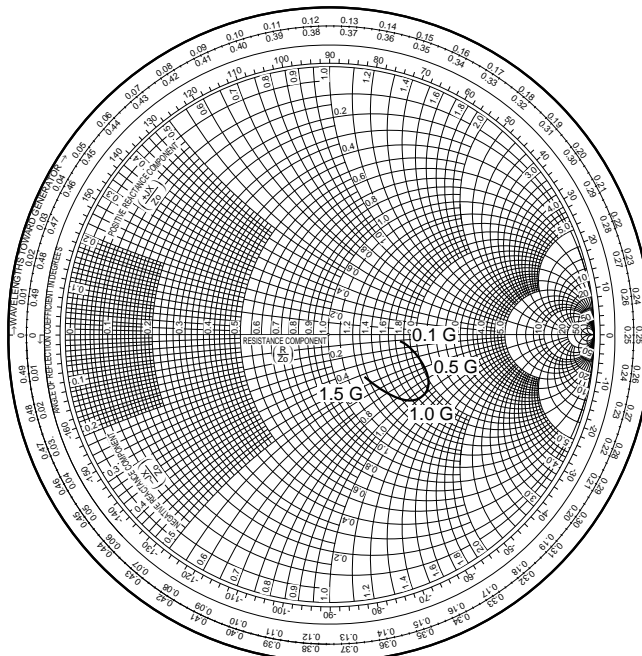

Typical S Parameter Values (T_A = +25 °C)

μPC2746TB

V_{CC} = 3.0 V, I_{CC} = 7.7 mA

FREQUENCY MHz	S11		S21		S12		S22		K
	MAG	ANG	MAG	ANG	MAG	ANG	MAG	ANG	
100.0000	.146	165.0	6.443	-19.4	.001	77.0	.403	-5.3	108.63
200.0000	.130	141.7	6.594	-38.7	.003	51.8	.406	-8.6	20.56
300.0000	.117	117.9	6.623	-58.1	.004	47.7	.418	-11.0	16.33
400.0000	.128	100.8	6.522	-77.5	.005	51.1	.417	-14.0	12.34
500.0000	.139	90.8	6.613	-96.9	.008	33.1	.424	-16.2	8.14
600.0000	.145	83.1	6.481	-116.1	.009	21.7	.422	-19.4	7.22
700.0000	.135	77.0	6.424	-135.1	.010	14.7	.426	-23.8	6.52
800.0000	.131	67.4	6.353	-153.6	.011	-4	.433	-27.7	5.63
900.0000	.119	49.3	6.234	-172.1	.014	-10.5	.442	-32.1	4.80
1000.0000	.142	30.4	6.137	169.6	.015	-24.2	.455	-34.7	4.44
1100.0000	.170	18.0	5.992	151.1	.016	-28.7	.455	-37.5	4.02
1200.0000	.219	10.6	5.972	133.3	.019	-48.0	.453	-39.7	3.49
1300.0000	.245	7.4	5.867	115.1	.019	-63.4	.433	-42.7	3.40
1400.0000	.268	3.1	5.679	97.0	.022	-72.2	.409	-45.5	3.16
1500.0000	.270	1.5	5.582	79.1	.021	-86.9	.375	-48.3	3.38
1600.0000	.268	-3.9	5.380	61.8	.022	-99.6	.349	-49.9	3.36
1700.0000	.258	-7.8	5.122	44.5	.024	-110.7	.318	-50.0	3.42
1800.0000	.251	-14.3	4.880	27.9	.024	-122.9	.294	-49.2	3.67
1900.0000	.249	-16.7	4.634	11.7	.025	-135.3	.268	-45.4	3.73
2000.0000	.240	-20.5	4.475	-4.4	.026	-146.0	.248	-40.5	3.91

PACKAGE DIMENSIONS

6 pin super minimold (unit : mm)

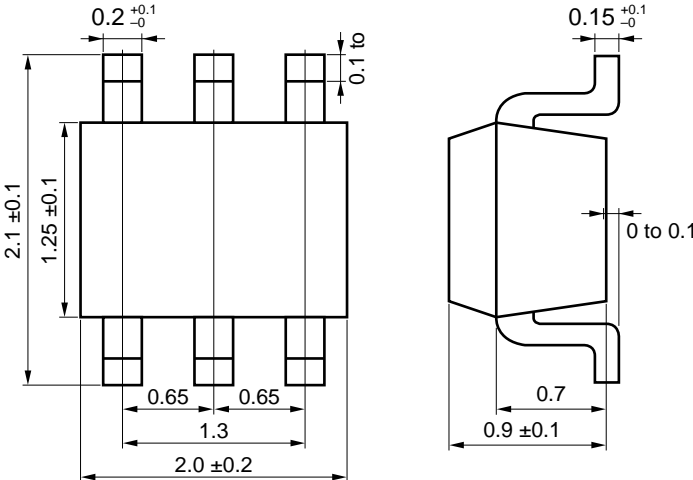

NOTES ON CORRECT USE

- (1) Observe precautions for handling because of electro-static sensitive devices.
- (2) Form a ground pattern as wide as possible to minimize ground impedance (to prevent undesired oscillation). All the ground pins must be connected together with wide ground pattern to decrease impedance difference.
- (3) The bypass capacitor should be attached to Vcc line.
- (4) The DC cut capacitor must be each attached to input and output pin.

RECOMMENDED SOLDERING CONDITIONS

This product should be soldered in the following recommended conditions. Other soldering methods and conditions than the recommended conditions are to be consulted with our sales representatives.

μPC2745TB, μPC2746TB

Soldering method	Soldering conditions	Recommended condition symbol
Infrared ray reflow	Package peak temperature : 235 °C, Hour : within 30 s. (more than 210 °C) Time : 3 times, Limited days : no.*	IR35-00-3
VPS	Package peak temperature : 215 °C, Hour : within 40 s. (more than 200 °C) Time : 3 times, Limited days : no.*	VP15-00-3
Wave soldering	Soldering tub temperature : less than 260 °C, Hour : within 10 s. Time : 1 times, Limited days : no.*	WS60-00-1
Pin part heating	Pin area temperature : 300 °C, Hour : within 3 s/pin. Limited days : no.*	

* It is the storage days after opening a dry pack, the storage conditions are 25 °C, less than 65 % RH.

Note 1. The combined use of soldering method is to be avoided (However, except the pin area heating method).

For details of recommended soldering conditions for surface mounting, refer to information document SEMICONDUCTOR DEVICE MOUNTING TECHNOLOGY MANUAL (C10535E).

[MEMO]

[MEMO]

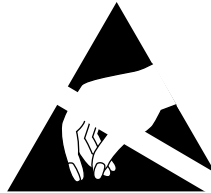

ATTENTION

OBSERVE PRECAUTIONS
FOR HANDLING
ELECTROSTATIC
SENSITIVE
DEVICES

No part of this document may be copied or reproduced in any form or by any means without the prior written consent of NEC Corporation. NEC Corporation assumes no responsibility for any errors which may appear in this document.

NEC Corporation does not assume any liability for infringement of patents, copyrights or other intellectual property rights of third parties by or arising from use of a device described herein or any other liability arising from use of such device. No license, either express, implied or otherwise, is granted under any patents, copyrights or other intellectual property rights of NEC Corporation or others.

While NEC Corporation has been making continuous effort to enhance the reliability of its semiconductor devices, the possibility of defects cannot be eliminated entirely. To minimize risks of damage or injury to persons or property arising from a defect in an NEC semiconductor device, customers must incorporate sufficient safety measures in its design, such as redundancy, fire-containment, and anti-failure features.

NEC devices are classified into the following three quality grades:

"Standard", "Special", and "Specific". The Specific quality grade applies only to devices developed based on a customer designated "quality assurance program" for a specific application. The recommended applications of a device depend on its quality grade, as indicated below. Customers must check the quality grade of each device before using it in a particular application.

Standard: Computers, office equipment, communications equipment, test and measurement equipment, audio and visual equipment, home electronic appliances, machine tools, personal electronic equipment and industrial robots

Special: Transportation equipment (automobiles, trains, ships, etc.), traffic control systems, anti-disaster systems, anti-crime systems, safety equipment and medical equipment (not specifically designed for life support)

Specific: Aircrafts, aerospace equipment, submersible repeaters, nuclear reactor control systems, life support systems or medical equipment for life support, etc.

The quality grade of NEC devices is "Standard" unless otherwise specified in NEC's Data Sheets or Data Books. If customers intend to use NEC devices for applications other than those specified for Standard quality grade, they should contact an NEC sales representative in advance.

Anti-radioactive design is not implemented in this product.

M4 96.5

NESAT (NEC Silicon Advanced Technology) is a trademark of NEC Corporation.