

FEATURES

- **WIDE FREQUENCY RESPONSE:** 1500 MHz
- **LOW VOLTAGE OPERATION:** 3 V NOMINAL (1.8 MIN)
- **LOW POWER CONSUMPTION:** 22.5 mW TYP
- **SUPER SMALL PACKAGE**
- **TAPE AND REEL PACKAGING OPTION AVAILABLE**

DESCRIPTION

The UPC2746T is a Silicon Monolithic integrated circuit which is manufactured using the NESAT III process. The NESAT III process produces transistors with f_T approaching 20 GHz. This device is suitable as a buffer amplifier for cellular and cordless telephone applications. Operating on a 3 volt supply (1.8 volt minimum) this IC is ideally suited for hand-held, portable designs.

NEC's stringent quality assurance and test procedures ensure the highest reliability and performance.

ELECTRICAL CHARACTERISTICS ($T_A = 25^\circ\text{C}$, $Z_L = Z_S = 50\Omega$)

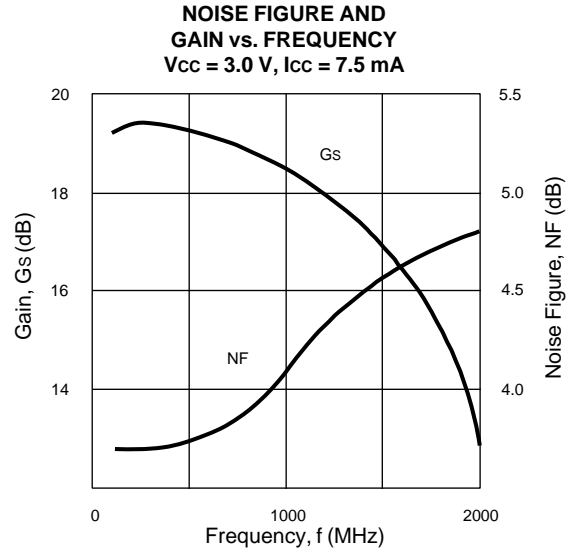

PART NUMBER PACKAGE OUTLINE			UPC2746T TO6		
SYMBOLS	PARAMETERS AND CONDITIONS	UNITS	MIN	TYP	MAX
I _{CC}	Circuit Current (no signal) $V_{CC} = 3.0\text{ V}$ $V_{CC} = 1.8\text{ V}$	mA mA	5.0	7.5 4.5	10.0
G _s	Small Signal Gain, $f = 500\text{ MHz}$, $V_{CC} = 3.0\text{ V}$ $f = 1000\text{ MHz}$, $V_{CC} = 3.0\text{ V}$ $f = 500\text{ MHz}$, $V_{CC} = 1.8\text{ V}$	dB dB dB	16	19 18.5 14	21
f _{u1}	Upper Limit Operating Frequency, $V_{CC} = 3.0\text{ V}$ $V_{CC} = 1.8\text{ V}$	GHz GHz	1.1	1.5 1.1	
P _{SAT}	Saturated Output Power, $f = 500\text{ MHz}$, $V_{CC} = 3.0\text{ V}$ $f = 1000\text{ MHz}$, $V_{CC} = 3.0\text{ V}$ $f = 500\text{ MHz}$, $V_{CC} = 1.8\text{ V}$	dBm dBm dBm	-3	0 -1 -8	
NF	Noise Figure, $f = 500\text{ MHz}$, $V_{CC} = 3.0\text{ V}$ $f = 1000\text{ MHz}$, $V_{CC} = 3.0\text{ V}$ $f = 500\text{ MHz}$, $V_{CC} = 1.8\text{ V}$	dB dB dB		4.0 4.2 5.0	5.5
R _{LIN}	Input Return Loss, $f = 500\text{ MHz}$, $V_{CC} = 3.0\text{ V}$ $f = 1000\text{ MHz}$, $V_{CC} = 3.0\text{ V}$ $f = 500\text{ MHz}$, $V_{CC} = 1.8\text{ V}$	dB dB dB	10	13 10 10	
R _{LOUT}	Output Return Loss, $f = 500\text{ MHz}$, $V_{CC} = 3.0\text{ V}$ $f = 1000\text{ MHz}$, $V_{CC} = 3.0\text{ V}$ $f = 500\text{ MHz}$, $V_{CC} = 1.8\text{ V}$	dB dB dB	5.5	8.5 8.5 9.5	
ISOL	Isolation, $f = 500\text{ MHz}$, $V_{CC} = 3.0\text{ V}$ $f = 1000\text{ MHz}$, $V_{CC} = 3.0\text{ V}$ $f = 500\text{ MHz}$, $V_{CC} = 1.8\text{ V}$	dB dB dB	40	45 38 37	
OIP ₃	SSB Output Third Order Intercept, $f_1 = 500\text{ MHz}$, $f_2 = 510\text{ MHz}$, $V_{CC} = 3.0\text{ V}$ $f_1 = 1000\text{ MHz}$, $f_2 = 1010\text{ MHz}$, $V_{CC} = 3.0\text{ V}$ $f_1 = 500\text{ MHz}$, $f_2 = 502\text{ MHz}$, $V_{CC} = 1.8\text{ V}$	dBm dBm dBm		+5 +6 -2	
R _{TH} (J-A)	Thermal Resistance (Junction to Ambient) Free Air Mounted on a 50 x 50 x 1.6 mm epoxy glass PWB	$^\circ\text{C/W}$ $^\circ\text{C/W}$			620 230

Note: 1. The gain at f_u is 3 dB down from the gain at 100 MHz.

ABSOLUTE MAXIMUM RATINGS¹ (T_A = 25°C)

SYMBOLS	PARAMETERS	UNITS	RATINGS
V _{CC}	Supply Voltage	V	4.0
I _{CC}	Total Supply Current	mA	16
P _{IN}	Input Power	dBm	0
P _T	Total Power Dissipation ²	mW	280
T _{OP}	Operating Temperature	°C	-40 to +85
T _{STG}	Storage Temperature	°C	-55 to +150

Notes:

1. Operation in excess of any one of these parameters may result in permanent damage.
2. Mounted on a 50 x 50 x 1.6 mm epoxy glass PWB (T_A = 85°C).

RECOMMENDED OPERATING CONDITIONS

SYMBOLS	PARAMETERS	UNITS	MIN	TYP	MAX
V _{CC}	Supply Voltage	V	1.8	3	3.3
T _{OP}	Operating Temperature	°C	-40	25	85

TEST CIRCUIT

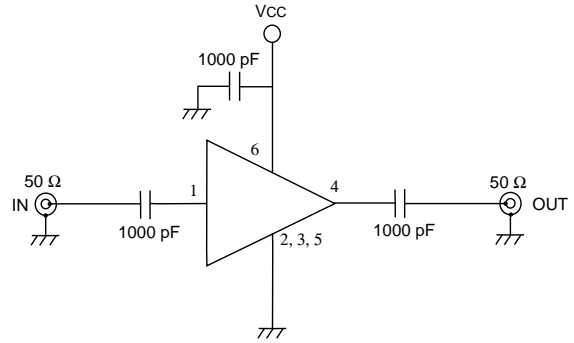

TYPICAL PERFORMANCE CURVES (T_A = 25°C)

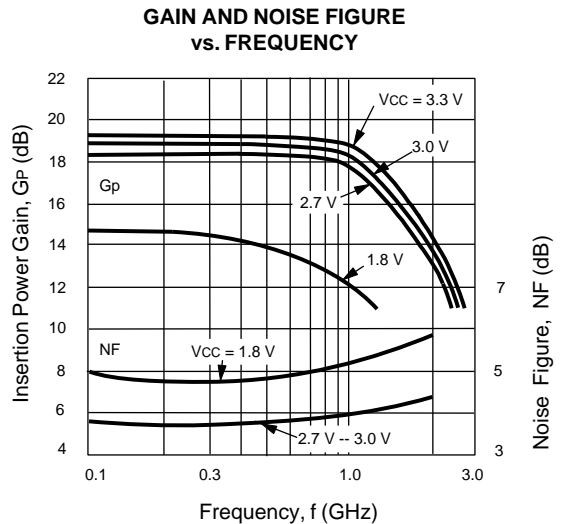
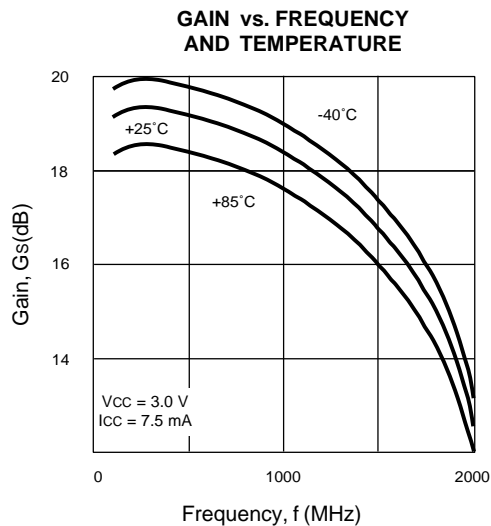
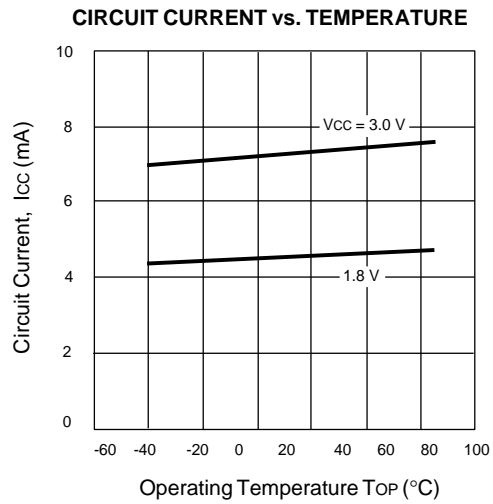
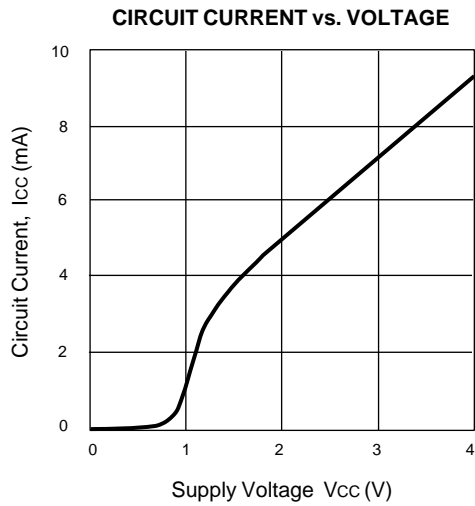

TYPICAL PERFORMANCE CURVES (TA = 25°C)

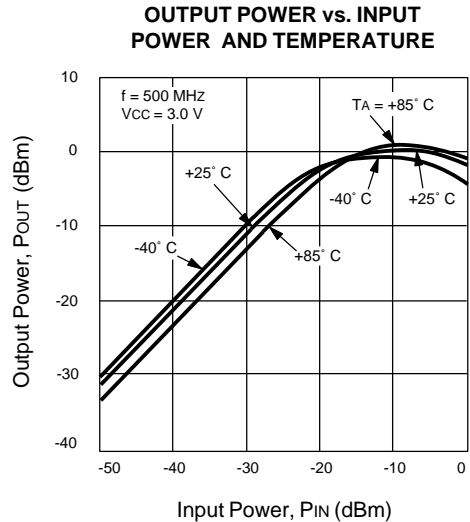
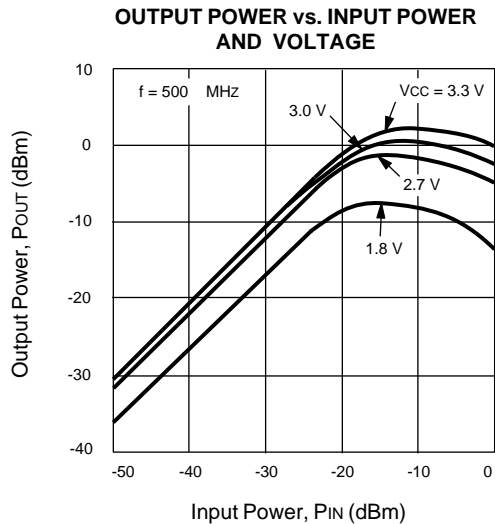
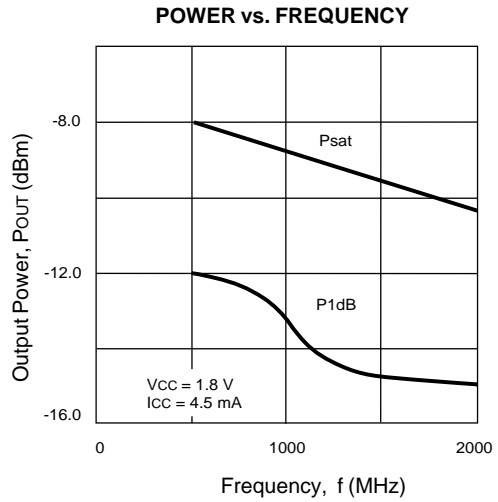
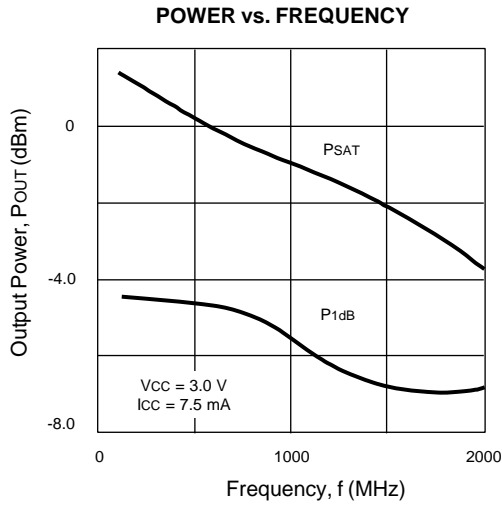
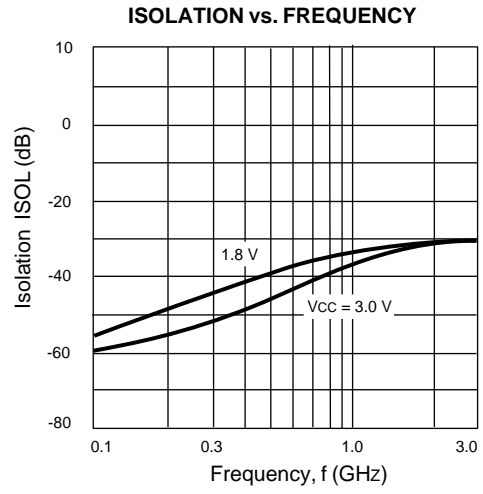
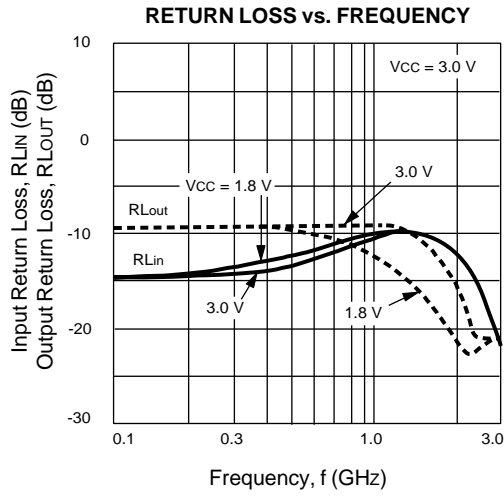

TYPICAL SCATTERING PARAMETERS (TA = 25°C)

VCC = 3.0 V, ICC = 7.5 mA

FREQUENCY (GHz)	S11		S21		S12		S22		K ¹	S21 (dB)
	MAG	ANG	MAG	ANG	MAG	ANG	MAG	ANG		
0.1	0.213	164.0	9.11	-6.4	0.001	122.7	0.362	-2.5	45.48	19.2
0.2	0.204	146.5	9.30	-15.3	0.002	118.8	0.359	-6.0	22.39	19.4
0.3	0.197	130.0	9.30	-25.0	0.003	114.7	0.365	-9.2	14.88	19.4
0.4	0.201	117.8	9.23	-34.3	0.004	110.5	0.370	-12.0	11.17	19.3
0.5	0.209	106.1	9.17	-43.6	0.005	106.6	0.378	-15.6	8.89	19.2
0.6	0.219	93.9	9.08	-53.0	0.006	102.4	0.382	-19.7	7.41	19.2
0.7	0.231	87.3	8.91	-62.0	0.008	98.8	0.389	-23.9	5.59	19.0
0.8	0.242	76.6	8.75	-71.9	0.009	94.6	0.389	-29.0	5.03	18.8
0.9	0.255	66.3	8.61	-81.5	0.011	90.8	0.393	-34.8	4.13	18.7
1.0	0.265	56.2	8.46	-91.9	0.012	87.2	0.385	-40.5	3.86	18.5
1.1	0.275	45.6	8.15	-101.4	0.013	83.0	0.381	-47.5	3.68	18.2
1.2	0.286	35.5	7.79	-110.5	0.014	79.7	0.368	-52.4	3.59	17.8
1.3	0.296	26.5	7.44	-119.6	0.015	76.0	0.355	-58.9	3.53	17.4
1.4	0.300	18.6	6.98	-129.1	0.016	74.2	0.335	-64.3	3.57	16.9
1.5	0.296	11.5	6.55	-137.8	0.016	72.6	0.314	-70.1	3.88	16.3
1.6	0.292	4.7	6.08	-146.4	0.016	71.0	0.290	-75.1	4.27	15.7
1.7	0.288	-0.5	5.63	-153.8	0.016	68.9	0.264	-78.7	4.71	15.0
1.8	0.285	-4.4	5.21	-161.5	0.017	67.4	0.235	-81.4	4.88	14.3
1.9	0.281	-10.1	4.77	-168.8	0.017	65.8	0.206	-83.1	5.42	13.6
2.0	0.266	-16.2	4.25	-175.0	0.017	61.3	0.180	-84.8	6.21	12.6

VCC = 1.8 V, ICC = 4.5 mA

FREQUENCY GHz	S11		S21		S12		S22		K ¹	S21 (dB)
	MAG	ANG	MAG	ANG	MAG	ANG	MAG	ANG		
0.1	0.211	11.1	5.15	-8.7	0.003	38.3	0.355	-5.3	26.96	14.2
0.2	0.255	8.5	5.11	-19.8	0.004	43.9	0.355	-10.6	19.92	14.2
0.3	0.287	6.5	5.00	-31.2	0.006	49.3	0.353	-16.2	13.31	14.0
0.4	0.302	3.5	4.88	-41.2	0.008	54.9	0.346	-21.1	10.18	13.8
0.5	0.316	-1.5	4.73	-51.3	0.009	59.1	0.339	-26.1	9.29	13.5
0.6	0.329	-5.5	4.58	-61.1	0.011	61.0	0.329	-30.4	7.83	13.2
0.7	0.341	-9.9	4.41	-69.9	0.013	60.8	0.321	-35.8	6.85	12.9
0.8	0.352	-14.8	4.17	-79.8	0.014	59.3	0.305	-40.4	6.75	12.4
0.9	0.361	-19.2	3.94	-89.1	0.015	57.0	0.298	-46.1	6.64	11.9
1.0	0.367	-25.0	3.75	-100.0	0.016	54.6	0.277	-51.3	6.60	11.5
1.1	0.372	-29.5	3.57	-108.4	0.018	49.4	0.264	-56.2	6.18	11.1
1.2	0.378	-34.3	3.47	-114.7	0.019	45.7	0.247	-59.1	6.05	0.8
1.3	0.381	-38.7	3.26	-122.8	0.020	43.8	0.237	-63.7	6.13	10.3
1.4	0.375	-42.1	3.13	-131.0	0.020	42.9	0.219	-65.0	6.49	9.9
1.5	0.371	-47.2	2.95	-138.5	0.021	41.9	0.206	-69.6	6.62	9.4
1.6	0.363	-51.2	2.78	-145.6	0.021	41.0	0.187	-70.4	7.14	8.9
1.7	0.355	-56.1	2.60	-153.1	0.020	40.5	0.166	-71.8	8.14	8.3
1.8	0.337	-58.5	2.51	-158.7	0.020	40.1	0.155	-71.4	8.59	8.0
1.9	0.325	-61.2	2.40	-166.5	0.020	39.8	0.136	-69.7	9.12	7.6
2.0	0.312	-63.9	2.28	-171.6	0.019	39.6	0.120	-69.6	10.25	7.2

Note:

1. K Factor Calculation:

$$K = \frac{1 + |\Delta|^2 - |S_{11}|^2 - |S_{22}|^2}{2 |S_{12} S_{21}|}, \Delta = S_{11} S_{22} - S_{21} S_{12}$$

OUTLINE DIMENSIONS (Units in mm)

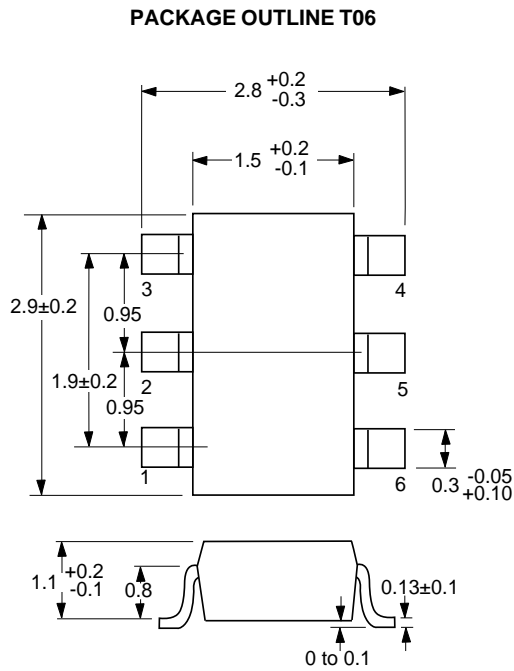

Note:
All dimensions are typical unless otherwise specified.

LEAD CONNECTIONS

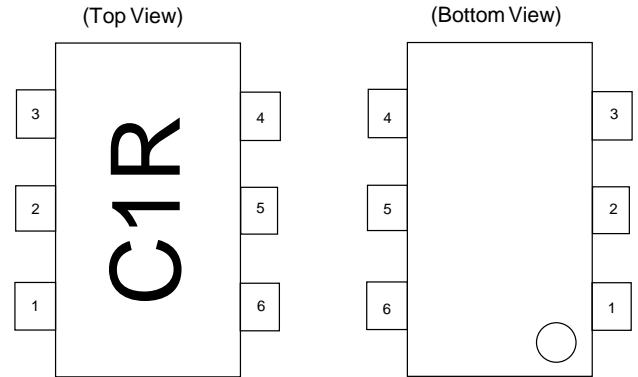

1. INPUT
2. GND
3. GND
4. OUTPUT
5. GND
6. Vcc

EQUIVALENT CIRCUIT

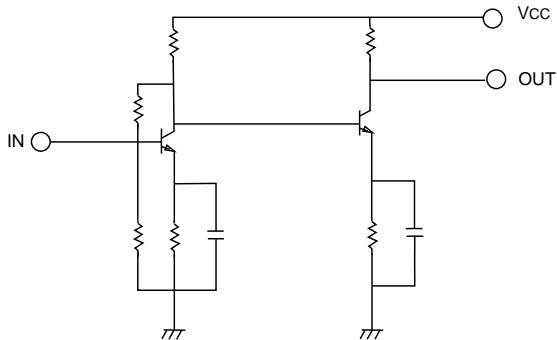

RECOMMENDED P.C.B. LAYOUT (Units in mm)

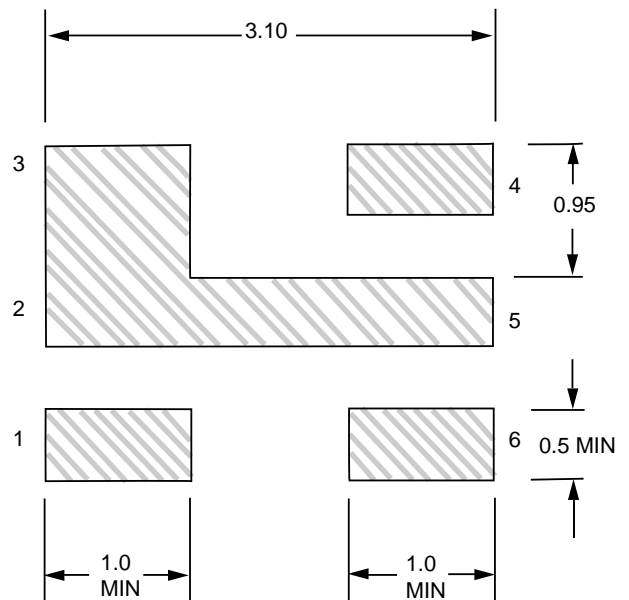

ORDERING INFORMATION

PART NUMBER	QTY
UPC2746T-E3	3K/Reel

Note:
Embossed Tape, 8 mm wide.