

FEATURES

- **2.8 dB NOISE FIGURE**
- **LOW VOLTAGE - LOW CURRENT:** 6 mA at 3 V
- **LOW POWER CONSUMPTION:** 18 mW TYP
- **SUPER SMALL PACKAGE**
- **TAPE AND REEL PACKAGING OPTION AVAILABLE**

DESCRIPTION

The UPC2748T is a Silicon Monolithic integrated circuit which is manufactured using the NESAT III process. The NESAT III process produces transistors with f_T approaching 20 GHz. This amplifier was designed for 900 MHz receivers in cellular and cordless telephone applications. Operating on a 3 volt supply (1.8 volt minimum) this IC is ideally suited for hand-held, portable designs.

NEC's stringent quality assurance and test procedures ensure the highest reliability and performance.

NOISE FIGURE AND GAIN vs. FREQUENCY
 $V_{CC} = 3.0 \text{ V}$, $I_{CC} = 6 \text{ mA}$

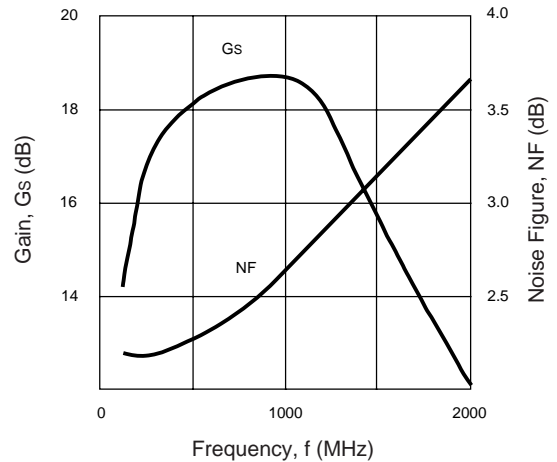

ELECTRICAL CHARACTERISTICS ($T_A = 25^\circ\text{C}$, $Z_L = Z_S = 50 \Omega$)

PART NUMBER PACKAGE OUTLINE			UPC2748T TO6		
SYMBOLS	PARAMETERS AND CONDITIONS	UNITS	MIN	TYP	MAX
I_{CC}	Circuit Current (no signal) $V_{CC} = 3.0 \text{ V}$ $V_{CC} = 1.8 \text{ V}$	mA mA	4.5	6.0 3.5	8.0
G_s	Small Signal Gain, $f = 900 \text{ MHz}$, $V_{CC} = 3.0 \text{ V}$ $f = 900 \text{ MHz}$, $V_{CC} = 1.8 \text{ V}$	dB dB	16	19 11.5	21
f_{L1}	Lower Limit Operating Frequency, $V_{CC} = 3.0 \text{ V}$ $V_{CC} = 1.8 \text{ V}$	GHz GHz		0.2 0.2	0.4
f_{U2}	Upper Limit Operating Frequency, $V_{CC} = 3.0 \text{ V}$ $V_{CC} = 1.8 \text{ V}$	GHz GHz	1.2	1.5 1.5	
P_{SAT}	Saturated Output Power, $f = 900 \text{ MHz}$, $V_{CC} = 3.0 \text{ V}$ $f = 900 \text{ MHz}$, $V_{CC} = 1.8 \text{ V}$	dBm dBm	-6	-3.5 -10	
NF	Noise Figure, $f = 900 \text{ MHz}$, $V_{CC} = 3.0 \text{ V}$ $f = 900 \text{ MHz}$, $V_{CC} = 1.8 \text{ V}$	dB dB		2.8 4.5	4.0
RL_{IN}	Input Return Loss, $f = 900 \text{ MHz}$, $V_{CC} = 3.0 \text{ V}$ $f = 900 \text{ MHz}$, $V_{CC} = 1.8 \text{ V}$	dB dB	8.5	11.5 10	
RL_{OUT}	Output Return Loss, $f = 900 \text{ MHz}$, $V_{CC} = 3.0 \text{ V}$ $f = 900 \text{ MHz}$, $V_{CC} = 1.8 \text{ V}$	dB dB	5.5	8.5 12	
ISOL	Isolation, $f = 900 \text{ MHz}$, $V_{CC} = 3.0 \text{ V}$ $f = 900 \text{ MHz}$, $V_{CC} = 1.8 \text{ V}$	dB dB	35	40 34	
OIP3	SSB Output Third Order Intercept, $f_1 = 500 \text{ MHz}$, $f_2 = 510 \text{ MHz}$, $V_{CC} = 3.0 \text{ V}$ $f_1 = 900 \text{ MHz}$, $f_2 = 902 \text{ MHz}$, $V_{CC} = 3.0 \text{ V}$ $f_1 = 1000 \text{ MHz}$, $f_2 = 1010 \text{ MHz}$, $V_{CC} = 3.0 \text{ V}$ $f_1 = 900 \text{ MHz}$, $f_2 = 902 \text{ MHz}$, $V_{CC} = 1.8 \text{ V}$	dBm dBm dBm dBm		-1 -2 -2 -6	
$R_{TH} (J-A)$	Thermal Resistance (Junction to Ambient) Free Air Mounted on a 50 x 50 x 1.6 mm epoxy glass PWB	$^\circ\text{C/W}$ $^\circ\text{C/W}$			620 230

Notes:

1. The gain at f_L is 3 dB down from the gain at 900 MHz.
2. The gain at f_U is 3 dB down from the gain at 900 MHz.

ABSOLUTE MAXIMUM RATINGS¹ (T_A = 25°C)

SYMBOLS	PARAMETERS	UNITS	RATINGS
V _{CC}	Supply Voltage	V	4.0
I _{CC}	Total Supply Current	mA	15
P _{IN}	Input Power	dBm	0
P _T	Total Power Dissipation ²	mW	280
T _{OP}	Operating Temperature	°C	-40 to +85
T _{STG}	Storage Temperature	°C	-55 to +150

Notes:

1. Operation in excess of any one of these parameters may result in permanent damage.
2. Mounted on a 50 x 50 x 1.6 mm epoxy glass PWB (T_A = 85°C).

RECOMMENDED OPERATING CONDITIONS

SYMBOLS	PARAMETERS	UNITS	MIN	TYP	MAX
V _{CC}	Supply Voltage	V	1.8	3	3.3
T _{OP}	Operating Temperature	°C	-40	25	85

TEST CIRCUIT

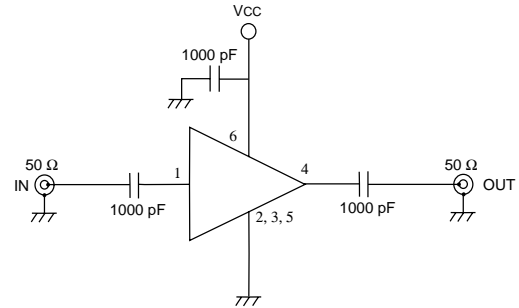

TYPICAL PERFORMANCE CURVES (T_A = 25°C)

CURRENT vs. SUPPLY VOLTAGE

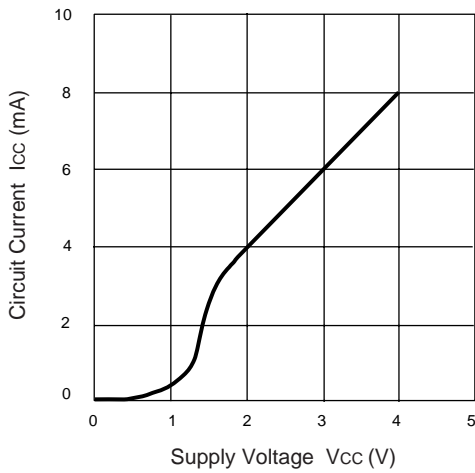

CURRENT vs. TEMPERATURE

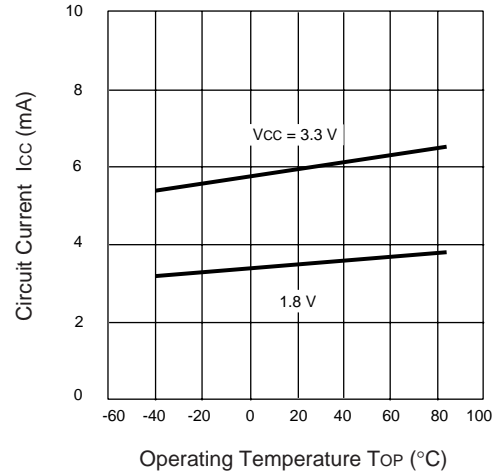

GAIN vs. FREQUENCY AND TEMPERATURE

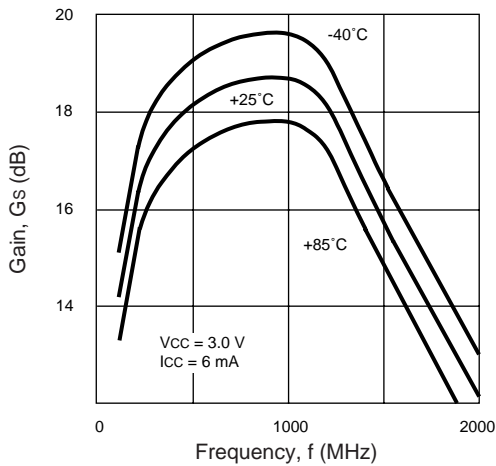

NOISE FIGURE vs. FREQUENCY

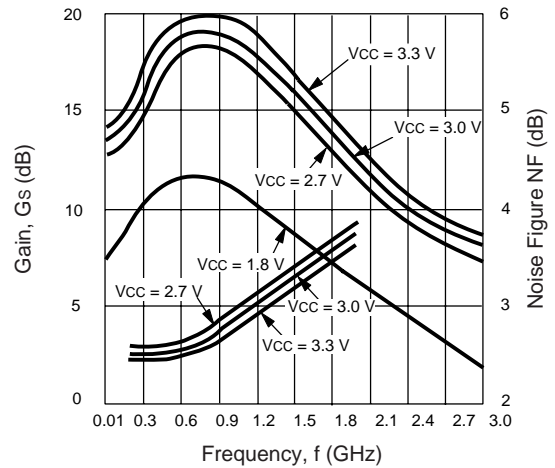

TYPICAL PERFORMANCE CURVES (TA = 25°C)

ISOLATION vs. FREQUENCY

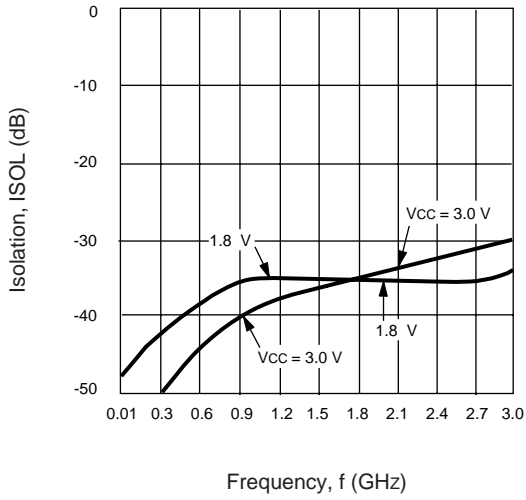

RETURN LOSS vs. FREQUENCY

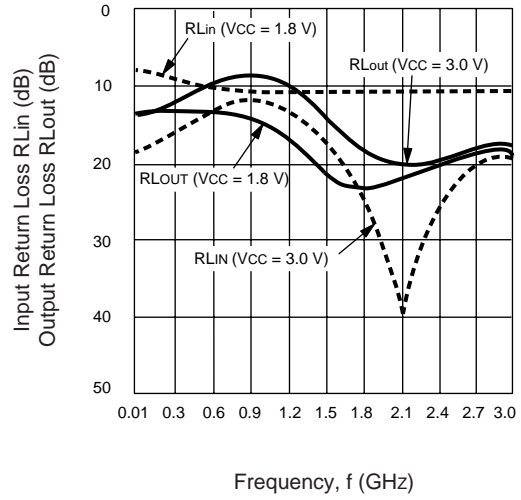

POWER vs. FREQUENCY

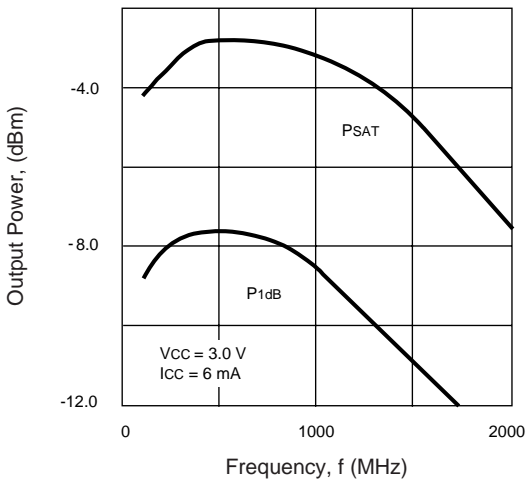

POWER vs. FREQUENCY

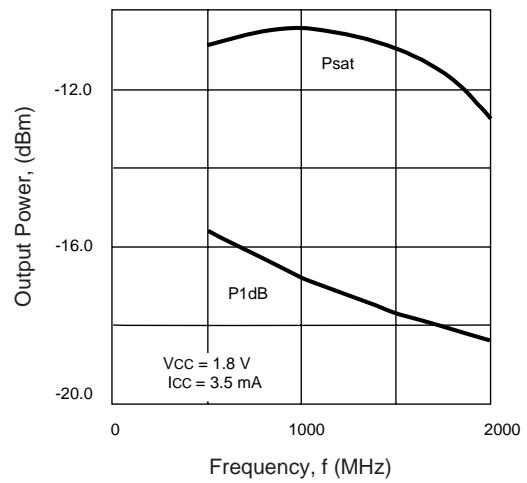

OUTPUT POWER vs. INPUT POWER AND VOLTAGE

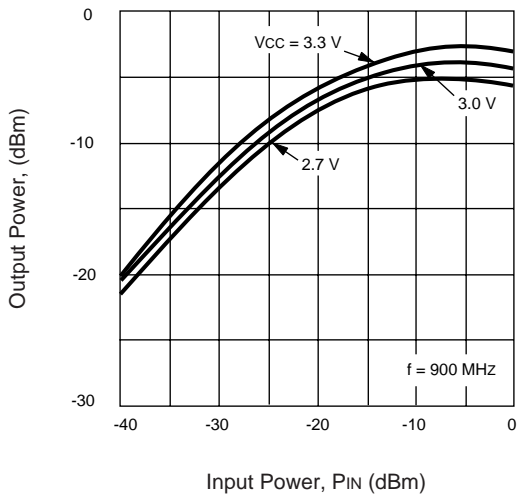

OUTPUT POWER vs. INPUT POWER AND TEMPERATURE

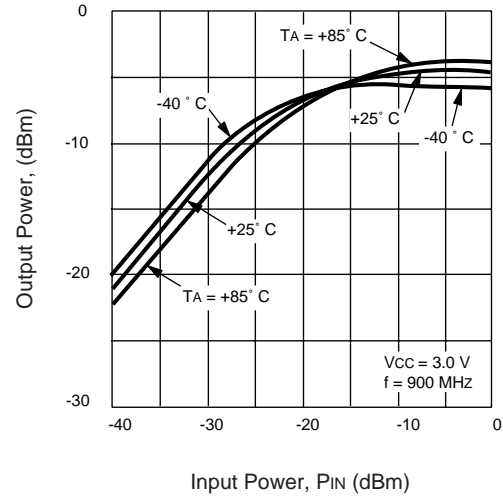

TYPICAL SCATTERING PARAMETERS (TA = 25°C)

VCC = 3.0 V, ICC = 6.0 mA

FREQUENCY (GHz)	S11		S21		S12		S22		K ¹	S21 (dB)
	MAG	ANG	MAG	ANG	MAG	ANG	MAG	ANG		
0.1	0.102	177.8	5.33	5.9	0.001	82.0	0.294	-0.1	84.81	14.5
0.2	0.115	-176.8	6.45	1.0	0.001	98.6	0.310	-4.3	69.14	16.2
0.3	0.138	-177.8	7.11	-10.1	0.002	103.8	0.318	-5.8	31.01	17.0
0.4	0.166	174.7	7.75	-21.3	0.002	110.7	0.325	-7.6	28.05	17.8
0.5	0.185	164.2	8.10	-32.3	0.003	117.3	0.338	-10.1	17.59	18.2
0.6	0.199	150.2	8.44	-44.1	0.004	117.2	0.352	-13.4	12.45	18.5
0.7	0.211	141.1	8.50	-54.4	0.005	115.5	0.364	-17.0	9.74	18.6
0.8	0.207	128.8	8.57	-67.4	0.006	114.4	0.376	-22.7	7.98	18.7
0.9	0.201	111.9	8.64	-79.6	0.008	108.2	0.387	-28.1	5.89	18.7
1.0	0.181	93.4	8.63	-94.0	0.009	101.8	0.392	-36.3	5.26	18.7
1.1	0.166	81.7	8.38	-104.5	0.011	95.2	0.382	-44.3	4.51	18.5
1.2	0.161	71.9	7.71	-115.6	0.011	90.2	0.364	-49.9	4.99	17.7
1.3	0.147	57.4	7.30	-126.6	0.011	88.2	0.344	-57.0	5.37	17.3
1.4	0.131	47.7	6.67	-137.3	0.012	83.9	0.316	-62.4	5.53	16.5
1.5	0.121	37.1	6.21	-146.9	0.011	78.5	0.289	-67.9	6.62	15.9
1.6	0.104	26.8	5.70	-156.0	0.011	79.4	0.262	-72.0	7.36	15.1
1.7	0.096	21.9	5.19	-163.7	0.012	83.7	0.232	-74.6	7.54	14.3
1.8	0.092	16.0	4.74	-171.1	0.013	87.9	0.207	-74.4	7.71	13.5
1.9	0.085	12.7	4.21	-179.0	0.014	90.1	0.176	-71.4	8.18	12.5
2.0	0.060	7.0	3.99	175.3	0.014	89.4	0.159	-65.0	8.71	12.0

VCC = 1.8 V, ICC = 3.5 mA

FREQUENCY (GHz)	S11		S21		S12		S22		K ¹	S21 (dB)
	MAG	ANG	MAG	ANG	MAG	ANG	MAG	ANG		
0.1	0.497	-9.3	1.99	5.3	0.005	81.3	0.309	-4.1	34.26	6.0
0.2	0.489	-16.0	2.44	-0.8	0.005	77.1	0.315	-9.1	28.13	7.7
0.3	0.470	-23.8	2.81	-13.1	0.006	73.0	0.318	-14.6	20.80	9.0
0.4	0.439	-29.7	3.06	-26.8	0.008	68.9	0.316	-18.9	14.86	9.7
0.5	0.420	-34.3	3.18	-41.1	0.010	64.8	0.316	-24.7	11.66	10.0
0.6	0.412	-37.8	3.21	-55.1	0.012	60.7	0.310	-30.5	9.73	10.1
0.7	0.406	-43.0	3.19	-68.3	0.013	56.5	0.297	-36.8	9.16	10.1
0.8	0.413	-47.3	3.07	-81.7	0.015	52.4	0.280	-41.5	8.26	9.7
0.9	0.422	-53.1	2.91	-94.1	0.016	48.3	0.265	-48.4	8.17	9.3
1.0	0.427	-59.0	2.75	-108.1	0.016	43.8	0.240	-53.5	8.71	8.8
1.1	0.431	-66.8	2.58	-119.0	0.017	39.4	0.224	-58.3	8.77	8.2
1.2	0.432	-72.3	2.45	-127.0	0.017	34.9	0.207	-59.0	9.30	7.8
1.3	0.429	-79.5	2.30	-136.2	0.018	30.4	0.191	-63.6	9.45	7.2
1.4	0.423	-85.8	2.17	-145.4	0.018	28.5	0.171	-63.2	10.16	6.7
1.5	0.415	-91.2	2.01	-153.4	0.018	26.7	0.158	-65.8	11.12	6.1
1.6	0.406	-97.7	1.89	-161.5	0.017	24.8	0.142	-64.3	12.70	5.5
1.7	0.393	-103.9	1.78	-169.5	0.016	23.0	0.125	-61.1	14.58	5.0
1.8	0.379	-110.1	1.65	-174.4	0.014	21.1	0.112	-56.9	18.27	4.4
1.9	0.364	-115.7	1.53	178.2	0.013	19.3	0.101	-50.0	21.56	3.7
2.0	0.349	-122.2	1.40	170.8	0.012	17.5	0.093	-45.9	25.89	2.9

Note:

1. K Factor Calculation:

$$K = \frac{1 + |\Delta|^2 - |S_{11}|^2 - |S_{22}|^2}{2 |S_{12} S_{21}|}, \Delta = S_{11} S_{22} - S_{21} S_{12}$$

OUTLINE DIMENSIONS (Units in mm)

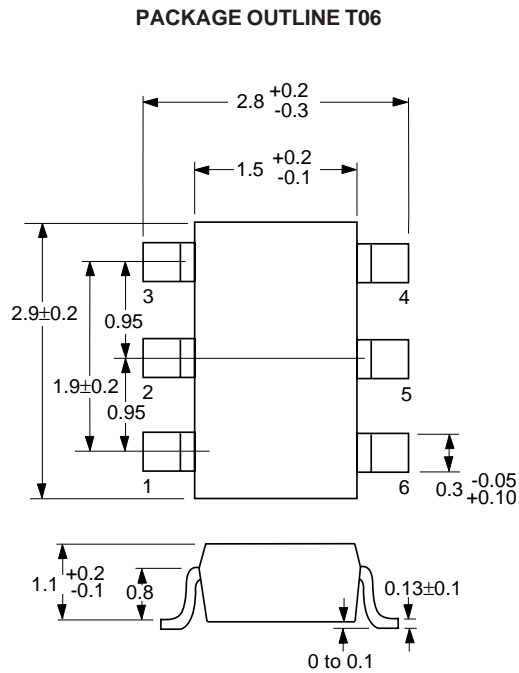

Note:
 All dimensions are typical unless otherwise specified.

LEAD CONNECTIONS

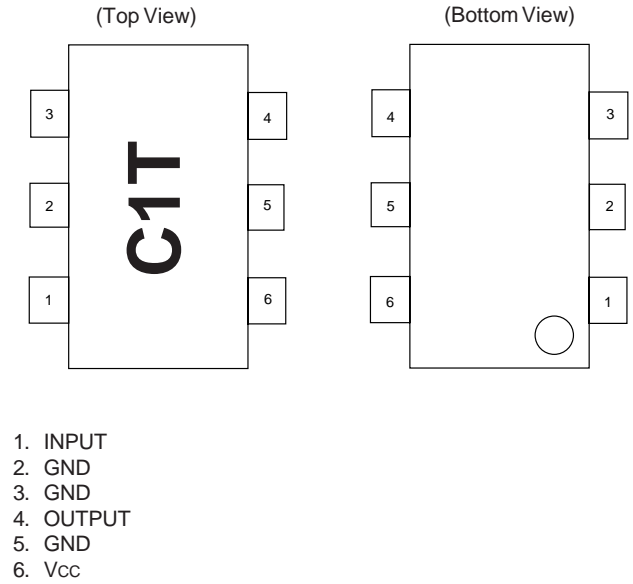

EQUIVALENT CIRCUIT

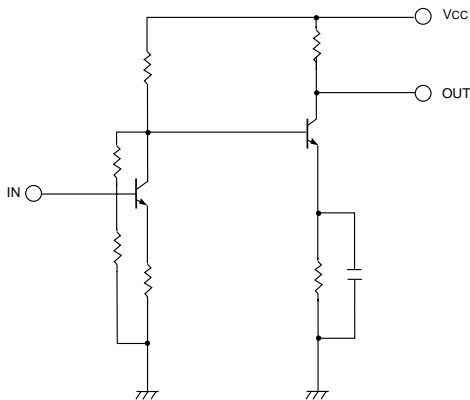

ORDERING INFORMATION

PART NUMBER	QTY
UPC2748T-E3	3K/Reel

Note:
 Embossed Tape, 8 mm wide.

RECOMMENDED P.C.B. LAYOUT (Units in mm)

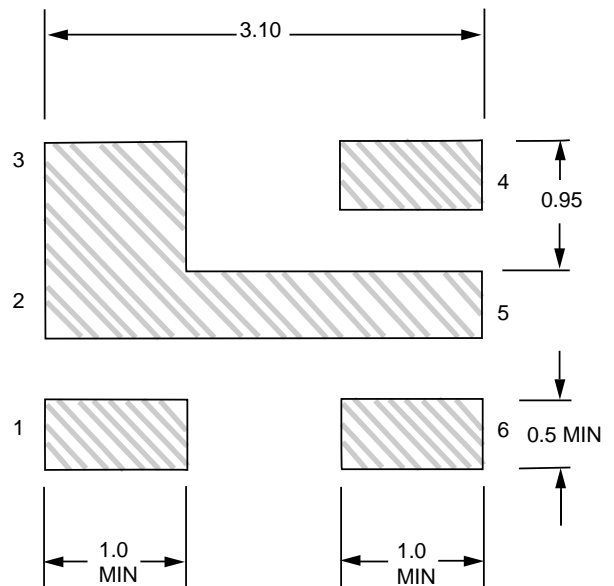

EXCLUSIVE NORTH AMERICAN AGENT FOR **NEC** RF, MICROWAVE & OPTOELECTRONIC SEMICONDUCTORS

CEL CALIFORNIA EASTERN LABORATORIES • Headquarters • 4590 Patrick Henry Drive • Santa Clara, CA 95054-1817 • (408) 988-3500 • Telex 34-6393 • FAX (408) 988-0279
 24-Hour Fax-On-Demand: 800-390-3232 (U.S. and Canada only) • Internet: <http://WWW.CEL.COM>

DATA SUBJECT TO CHANGE WITHOUT NOTICE

PRINTED IN USA ON RECYCLED PAPER -11/97