

FEATURES

- 16 dB GAIN WITH 4 dB NOISE FIGURE AT 1900 MHz
- LOW VOLTAGE - LOW CURRENT: 6 mA at 3 V
- LOW POWER CONSUMPTION: 18 mW TYP
- SUPER SMALL PACKAGE
- TAPE AND REEL PACKAGING OPTION AVAILABLE

DESCRIPTION

The UPC2749T is a Silicon Monolithic integrated circuit which is manufactured using the NESAT III process. The NESAT III process produces transistors with f_T approaching 20 GHz. This amplifier was designed for buffer amplifier applications in GPS and PCS applications. Operating on a 3 volt supply this IC is ideally suited for hand-held, portable designs.

NEC's stringent quality assurance and test procedures assure the highest reliability and performance.

NOISE FIGURE AND
GAIN vs. FREQUENCY
 $V_{CC} = 3.0 V$

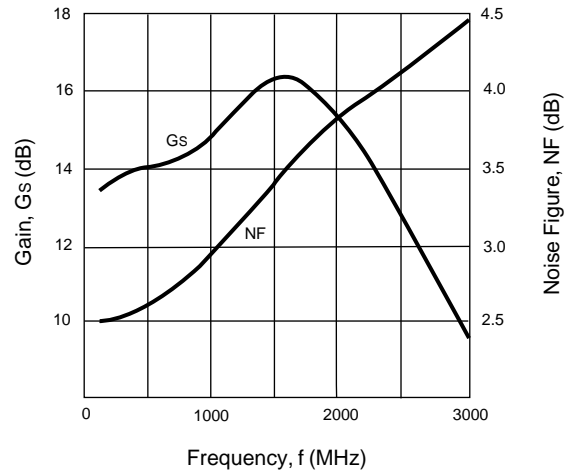

ELECTRICAL CHARACTERISTICS ($T_A = 25^\circ C$, $Z_L = Z_s = 50\Omega$, $V_{CC} = 3.0 V$)

PART NUMBER PACKAGE OUTLINE			UPC2749T TO6		
SYMBOLS	PARAMETERS AND CONDITIONS	UNITS	MIN	TYP	MAX
I_{CC}	Circuit Current (no signal)	mA	4	6	8
G_s	Small Signal Gain, f = 900 MHz f = 1900 MHz	dB dB	13	14.5 16	18.5
f_{u1}	Upper Limit Operating Frequency	GHz	2.5	2.9	
P_{1dB}	1 dB Compressed Output Power at 1900 MHz	dBm		-12.5	
P_{SAT}	Saturated Output Power, f = 1900 MHz	dBm	-9	-6	
NF	Noise Figure, f = 900 MHz f = 1900 MHz	dB dB		3.2 4.0	5.5
R_{LIN}	Input Return Loss, f = 1900 MHz	dB	7	10	
R_{LOUT}	Output Return Loss, f = 1900 MHz	dB	9.5	12.5	
ISOL	Isolation, f = 1900 MHz	dB	25	30	
OIP3	SSB Output Third Order Intercept, f ₁ = 500 MHz, f ₂ = 510 MHz f ₁ = 1000 MHz, f ₂ = 1010 MHz f ₁ = 1900 MHz, f ₂ = 1902 MHz f ₁ = 2000 MHz, f ₂ = 2010 MHz	dBm dBm dBm dBm		-3 -3 -3.5 -4	
$R_{TH} (J-A)$	Thermal Resistance (Junction to Ambient) Free Air Mounted on a 50 x 50 x 1.6 mm epoxy glass PWB	$^\circ C/W$ $^\circ C/W$			620 230

Note:

1. The gain at f_u is 3 dB down from the gain at 1900 MHz.

ABSOLUTE MAXIMUM RATINGS¹ (T_A = 25°C)

SYMBOLS	PARAMETERS	UNITS	RATINGS
V _{CC}	Supply Voltage	V	4.0
I _{CC}	Total Supply Current	mA	15
P _{IN}	Input Power	dBm	0
P _T	Total Power Dissipation ²	mW	280
T _{OP}	Operating Temperature	°C	-40 to +85
T _{STG}	Storage Temperature	°C	-55 to +150

Notes:

1. Operation in excess of any one of these parameters may result in permanent damage.
2. Mounted on a 50 x 50 x 1.6 mm epoxy glass PWB (T_A = 85°C).

RECOMMENDED OPERATING CONDITIONS

SYMBOLS	PARAMETERS	UNITS	MIN	TYP	MAX
V _{CC}	Supply Voltage	V	2.7	3	3.3
T _{OP}	Operating Temperature	°C	-40	25	85

TEST CIRCUIT

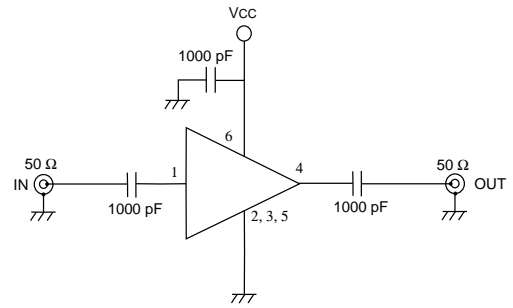

TYPICAL PERFORMANCE CURVES (T_A = 25°C)

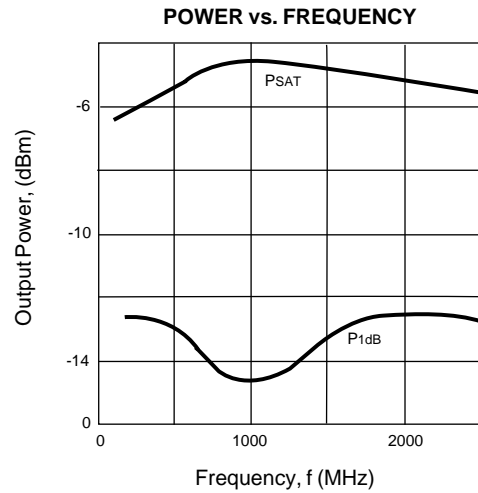
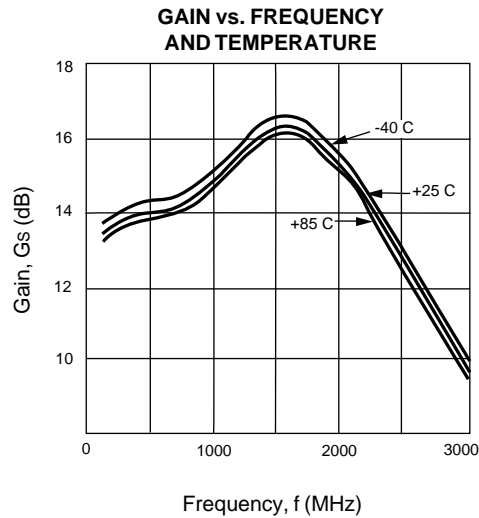

TYPICAL SCATTERING PARAMETERS (T_A = 25°C)

V_{CC} = 3.0 V, I_{CC} = 6 mA

FREQUENCY (GHz)	S ₁₁		S ₂₁		S ₁₂		S ₂₂		K ¹	S ₂₁ (dB)
	MAG	ANG	MAG	ANG	MAG	ANG	MAG	ANG		
0.10	0.049	1.9	4.67	1.3	0.001	150.9	0.009	-169.1	106.8	13.4
0.20	0.046	-23.9	4.85	-8.2	0.001	152.4	0.024	107.5	102.8	13.7
0.30	0.044	-55.1	4.95	-16.8	0.001	153.8	0.041	91.0	100.6	13.9
0.40	0.043	-89.7	4.97	-23.0	0.001	155.1	0.058	80.0	100.1	13.9
0.50	0.046	-132.7	4.99	-29.4	0.002	156.4	0.074	72.2	99.7	14.0
0.60	0.055	-164.0	5.01	-35.3	0.003	155.8	0.089	64.3	99.9	14.0
0.70	0.071	171.8	5.06	-41.0	0.004	155.9	0.105	56.5	99.9	14.1
0.80	0.094	153.8	5.19	-47.4	0.005	154.4	0.120	48.4	99.9	14.3
0.90	0.115	137.5	5.29	-54.0	0.006	152.4	0.138	39.7	99.9	14.5
1.00	0.138	127.5	5.51	-59.9	0.008	149.0	0.149	29.3	99.9	14.8
1.10	0.165	118.1	5.72	-67.2	0.011	145.4	0.160	20.2	99.9	15.1
1.20	0.199	107.8	5.94	-75.2	0.013	140.8	0.170	10.1	99.9	15.5
1.30	0.233	98.2	6.14	-84.2	0.016	135.5	0.178	-1.3	99.9	15.8
1.40	0.265	89.0	6.33	-93.4	0.019	128.9	0.181	-13.8	99.9	16.0
1.50	0.298	80.0	6.46	-103.3	0.021	123.0	0.179	-27.5	99.9	16.2
1.60	0.323	70.7	6.48	-113.7	0.024	116.1	0.171	-41.4	99.9	16.2
1.70	0.352	61.7	6.38	-124.3	0.025	107.8	0.158	-53.7	99.9	16.1
1.80	0.367	53.0	6.25	-133.9	0.027	105.5	0.141	-76.2	99.9	15.9
1.90	0.377	45.2	6.10	-144.3	0.028	101.6	0.123	-95.1	99.9	15.7
2.00	0.379	37.2	5.86	-153.7	0.031	96.7	0.110	-112.2	99.9	15.4
2.10	0.371	30.8	5.47	-163.9	0.032	91.3	0.094	-138.4	99.9	14.8
2.20	0.363	26.0	5.18	-172.1	0.032	87.1	0.094	-165.2	99.9	14.3
2.30	0.357	22.1	4.81	-179.8	0.033	83.2	0.094	168.2	99.9	13.6
2.40	0.350	19.0	4.49	173.0	0.033	80.6	0.104	145.0	99.9	13.0
2.50	0.340	16.1	4.17	166.1	0.033	78.6	0.118	126.5	99.9	12.4
2.60	0.331	14.4	3.92	160.0	0.033	77.3	0.136	112.6	99.9	11.9
2.70	0.321	12.3	3.64	153.7	0.033	76.2	0.155	99.5	99.9	11.2
2.80	0.311	11.8	3.44	148.7	0.034	74.8	0.174	91.5	99.9	10.7
2.90	0.301	10.8	3.19	142.9	0.035	74.5	0.193	81.5	99.9	10.1
3.00	0.290	10.2	3.03	138.1	0.036	73.2	0.210	75.3	99.9	9.6

Note:

1. K Factor Calculation:

$$K = \frac{1 + |\Delta|^2 - |S_{11}|^2 - |S_{22}|^2}{2 |S_{12} S_{21}|}, \Delta = S_{11} S_{22} - S_{21} S_{12}$$

OUTLINE DIMENSIONS (Units in mm)

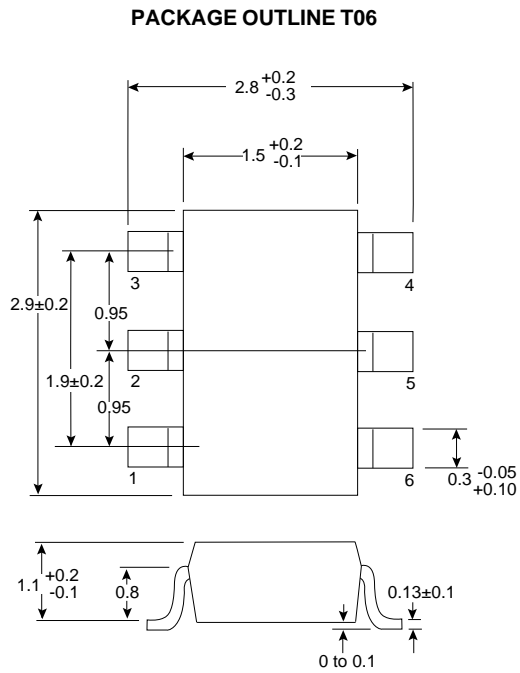

Note:
All dimensions are typical unless otherwise specified.

LEAD CONNECTIONS

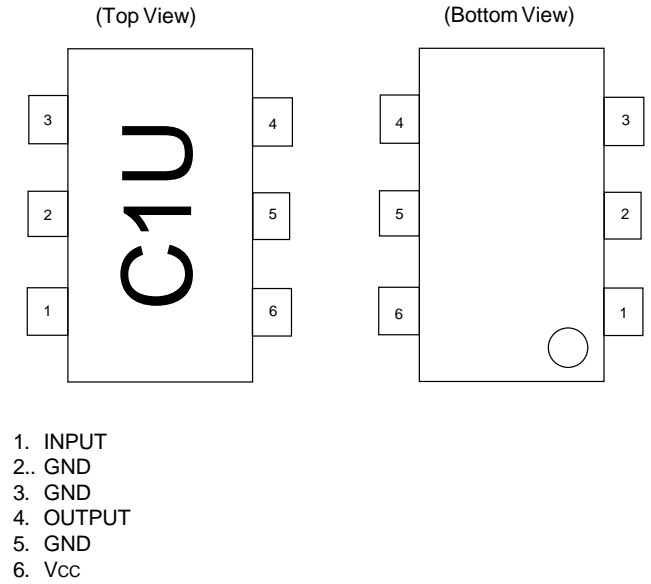

EQUIVALENT CIRCUIT

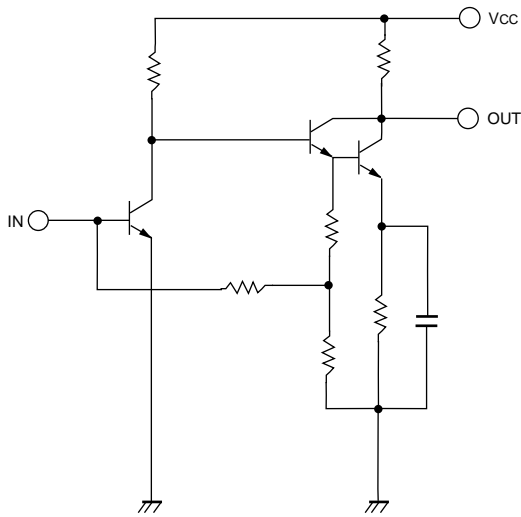

ORDERING INFORMATION

PART NUMBER	QTY
UPC2749T-E3	3K/Reel

Note:
Embossed Tape, 8 mm wide.

RECOMMENDED P.C.B. LAYOUT (Units in mm)

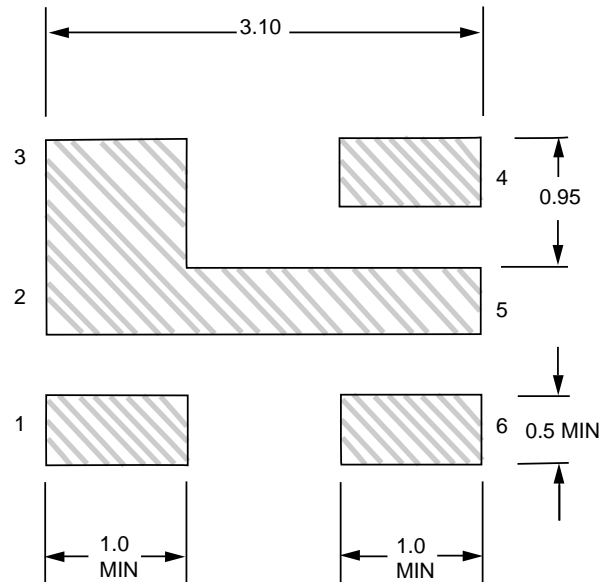

EXCLUSIVE AGENT FOR **NEC Corporation** RF & MICROWAVE SEMICONDUCTOR PRODUCTS - U.S. & CANADA