

BIPOLAR ANALOG INTEGRATED CIRCUIT

μ PC2749TB

3 V, SUPER MINIMOLD SILICON MMIC WIDEBAND AMPLIFIER FOR MOBILE COMMUNICATIONS

DESCRIPTION

The μ PC2749TB is a silicon monolithic integrated circuit designed as amplifier for mobile communications. This IC is packaged in super minimold package which is smaller than conventional minimold.

The μ PC2749TB has compatible pin connections and performance to μ PC2749T of conventional minimold version. So, in the case of reducing your system size, μ PC2749TB is suitable to replace from μ PC2749T.

This IC is manufactured using NEC's 20 GHz fr NESAT™ III silicon bipolar process. This process uses silicon nitride passivation film and gold electrodes. These materials can protect chip surface from external pollution and prevent corrosion/migration. Thus, this IC has excellent performance, uniformity and reliability.

FEATURES

- High-density surface mounting : 6-pin super minimold package
- Supply voltage : $V_{CC} = 2.7$ to 3.3 V
- Noise figure : NF = 4.0 dB TYP. @ $f = 1.9$ GHz
- Upper limit operating frequency : $f_u = 2.9$ GHz TYP. @ 3 dB down below from gain at $f = 0.9$ GHz

APPLICATION

- GPS receiver
- Wireless LAN

ORDERING INFORMATION

Part Number	Package	Marking	Supplying Form
μ PC2749TB-E3	6-pin super minimold	C1U	Embossed tape 8 mm wide. 1, 2, 3 pins face to perforation side of the tape. Qty 3 kp/reel.

Remark To order evaluation samples, please contact your local NEC sales office. (Part number for sample order: μ PC2749TB)

Caution Electro-static sensitive devices

The information in this document is subject to change without notice. Before using this document, please confirm that this is the latest version.

Not all devices/types available in every country. Please check with local NEC representative for availability and additional information.

PIN CONNECTIONS

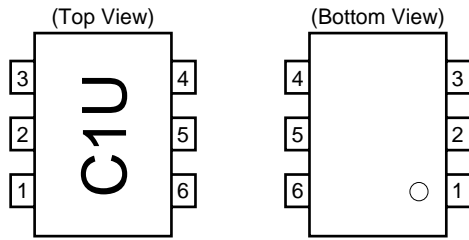

Pin No.	Pin Name
1	INPUT
2	GND
3	GND
4	OUTPUT
5	GND
6	V _{CC}

PRODUCT LINE-UP (T_A = +25°C, V_{CC} = 3.0 V, Z_L = Z_S = 50 Ω)

Part No.	f _u (GHz)	P _{O(sat)} (dBm)	G _P (dB)	NF (dB)	I _{CC} (mA)	Package	Marking
μPC2749T	2.9	-6.0	16	4.0	6.0	6-pin minimold	C1U
μPC2749TB						6-pin super minimold	

Remark Typical performance. Please refer to **ELECTRICAL CHARACTERISTICS** in detail.

Notice The package size distinguishes between minimold and super minimold.

SYSTEM APPLICATION EXAMPLE

EXAMPLE OF GPS RECEIVER

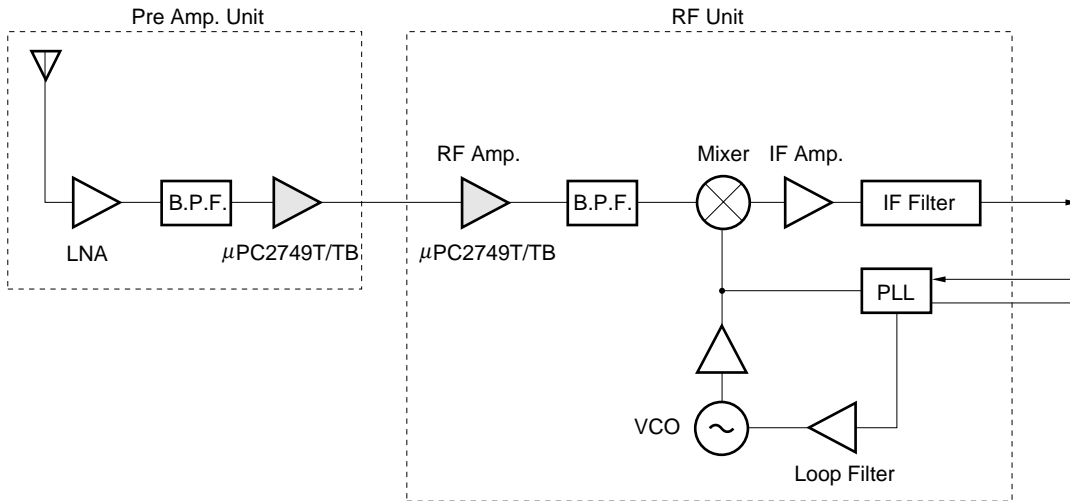

To know the associated products, please refer to each latest data sheet.

PIN EXPLANATION

Pin No.	Pin Name	Applied Voltage (V)	Pin Voltage (V) <small>Note</small>	Function and Applications	Internal Equivalent Circuit
1	INPUT	–	0.82	Signal input pin. A internal matching circuit, configured with resistors, enables 50 Ω connection over a wide band. This pin must be coupled to signal source with capacitor for DC cut.	
4	OUTPUT	–	2.87	Signal output pin. A internal matching circuit, configured with resistors, enables 50 Ω connection over a wide band. This pin must be coupled to next stage with capacitor for DC cut.	
6	Vcc	2.7 to 3.3	–	Power supply pin. This pin should be externally equipped with bypass capacity to minimize ground impedance.	
2 3 5	GND	0	–	Ground pin. This pin should be connected to system ground with minimum inductance. Ground pattern on the board should be formed as wide as possible. All the ground pins must be connected together with wide ground pattern to decrease impedance difference.	

Note Pin voltage is measured at Vcc = 3.0 V.

ABSOLUTE MAXIMUM RATINGS

Parameter	Symbol	Conditions	Ratings	Unit
Supply Voltage	V _{CC}	T _A = +25 °C	4.0	V
Total Circuit Current	I _{CC}	T _A = +25 °C	15	mA
Power Dissipation	P _D	Mounted on doublesided copper clad 50 × 50 × 1.6 mm epoxy glass PWB (T _A = +85°C)	200	mW
Operating Ambient Temperature	T _A		-40 to +85	°C
Storage Temperature	T _{stg}		-55 to +150	°C
Input Power	P _{in}	T _A = +25 °C	0	dBm

RECOMMENDED OPERATING CONDITIONS

Parameter	Symbol	MIN.	TYP.	MAX.	Unit
Supply Voltage	V _{CC}	2.7	3.0	3.3	V
Operating Ambient Temperature	T _A	-40	+25	+85	°C

ELECTRICAL CHARACTERISTICS (T_A = +25 °C, V_{CC} = 3.0 V, Z_S = Z_L = 50 Ω)

Parameter	Symbol	Test Conditions	MIN.	TYP.	MAX.	Unit
Circuit Current	I _{CC}	No Signal	4.0	6.0	8.0	mA
Power Gain	G _P	f = 1.9 GHz	13.0	16.0	18.5	dB
Maximum Output Level	P _{O(sat)}	f = 1.9 GHz, P _{in} = -6 dBm	-9.0	-6.0	-	dBm
Noise Figure	NF	f = 1.9 GHz	-	4.0	5.5	dB
Upper Limit Operating Frequency	f _u	3 dB down below flat gain at f = 0.9 GHz	2.5	2.9	-	GHz
Isolation	ISL	f = 1.9 GHz	25	30	-	dB
Input Return Loss	RL _{in}	f = 1.9 GHz	7	10	-	dB
Output Return Loss	RL _{out}	f = 1.9 GHz	9.5	12.5	-	dB

STANDARD CHARACTERISTICS FOR REFERENCE (T_A = +25 °C, V_{CC} = 3.0 V, Z_S = Z_L = 50 Ω)

Parameter	Symbol	Test Conditions	Reference Value	Unit
Power Gain	G _P	f = 0.9 GHz	14.5	dB
Noise Figure	NF	f = 0.9 GHz	3.2	dB
3rd Order Intermodulation Distortion	IM ₃	P _{out} = -20 dBm f ₁ = 1.900 GHz, f ₂ = 1.902 GHz	-33	dBc
Gain 1 dB Compression Output Level	P _{O(1 dB)}	f = 1.9 GHz	-12.5	dBm

TEST CIRCUIT

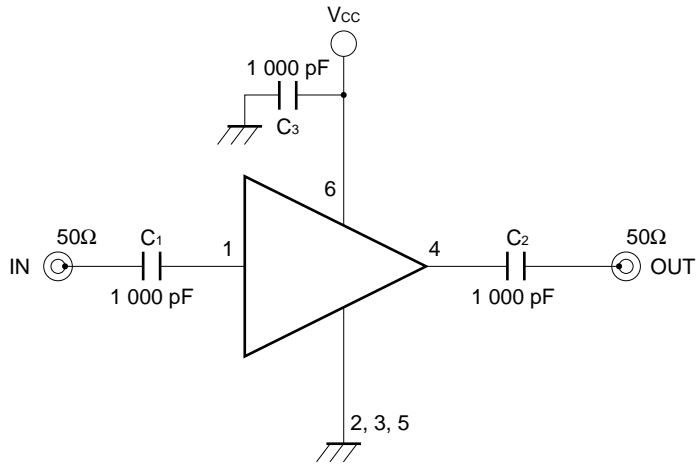

EXAMPLE OF APPLICATION CIRCUIT

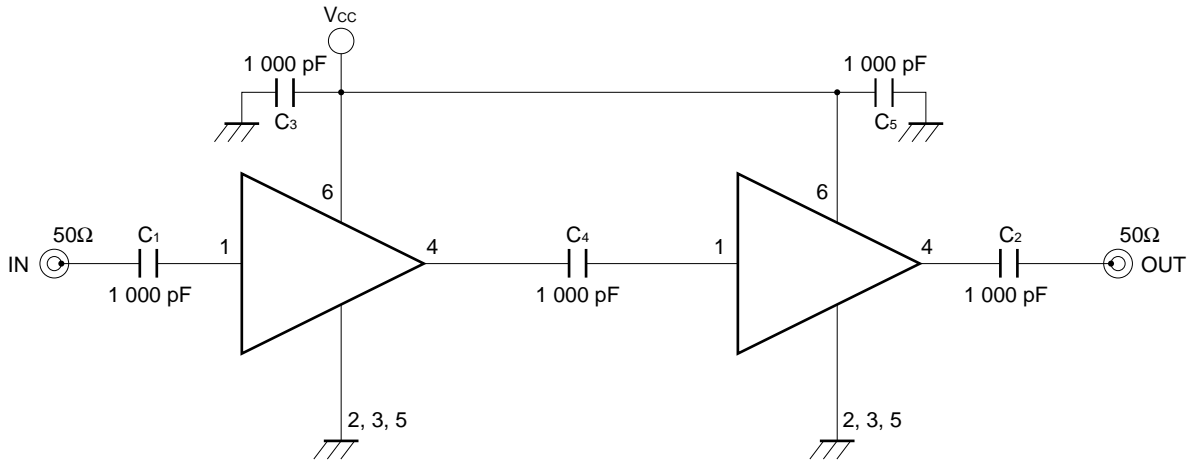

The application circuits and their parameters are for reference only and are not intended for use in actual design-ins.

CAPACITORS FOR THE V_{CC}, INPUT AND OUTPUT PINS

1 000 pF capacitors are recommendable as bypass capacitor for V_{CC} pin and coupling capacitors for input/output pins.

Bypass capacitor for V_{CC} pin is intended to minimize V_{CC} pin's ground impedance. Therefore, stable bias can be supplied against V_{CC} fluctuation.

Coupling capacitors for input/output pins are intended to minimize RF serial impedance and cut DC.

To get a flat gain from 100 MHz up, 1 000 pF capacitors are assembled on the test circuit. [Actually, 1 000 pF capacitors give flat gain at least 10 MHz. In the case of under 10 MHz operation, increase the value of coupling capacitor such as 2 200 pF. Because the coupling capacitors are determined by the equation of $C = 1/(2 \pi fZ_s)$.]

ILLUSTRATION OF THE TEST CIRCUIT ASSEMBLED ON EVALUATION BOARD

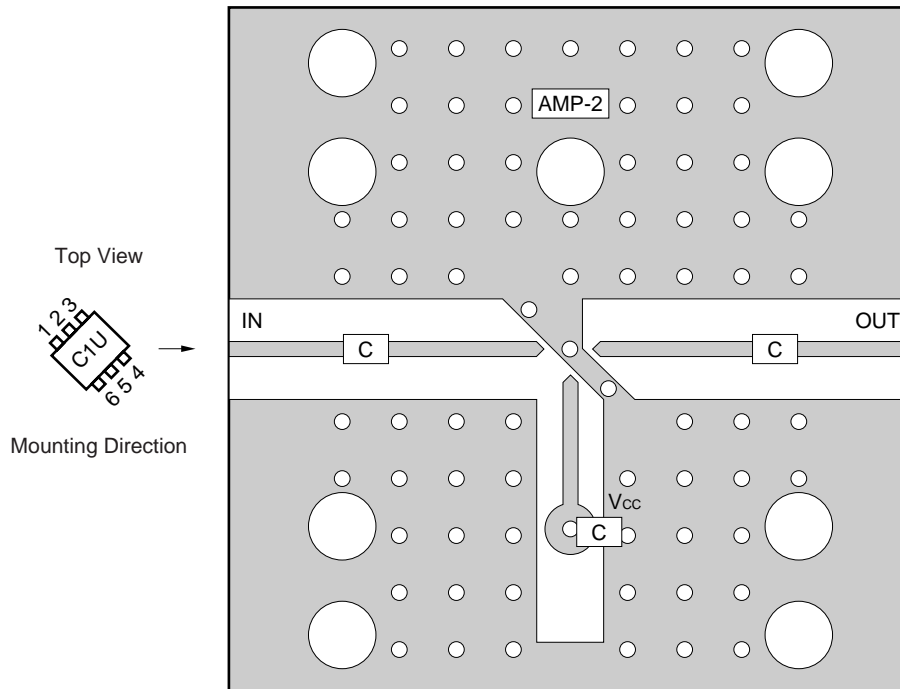

COMPONENT LIST

	Value
C	1 000 pF

Notes

1. 30 × 30 × 0.4 mm double sided copper clad polyimide board.
2. Back side: GND pattern
3. Solder plated on pattern
4. ○ ○ : Through holes

For more information on the use of this IC, refer to the following application note: USAGE AND APPLICATIONS OF 6-PIN MINI-MOLD, 6-PIN SUPER MINI-MOLD SILICON HIGH-FREQUENCY WIDEBAND AMPLIFIER MMIC (P11976E).

★ TYPICAL CHARACTERISTICS (Unless otherwise specified, $T_A = +25\text{ }^\circ\text{C}$)

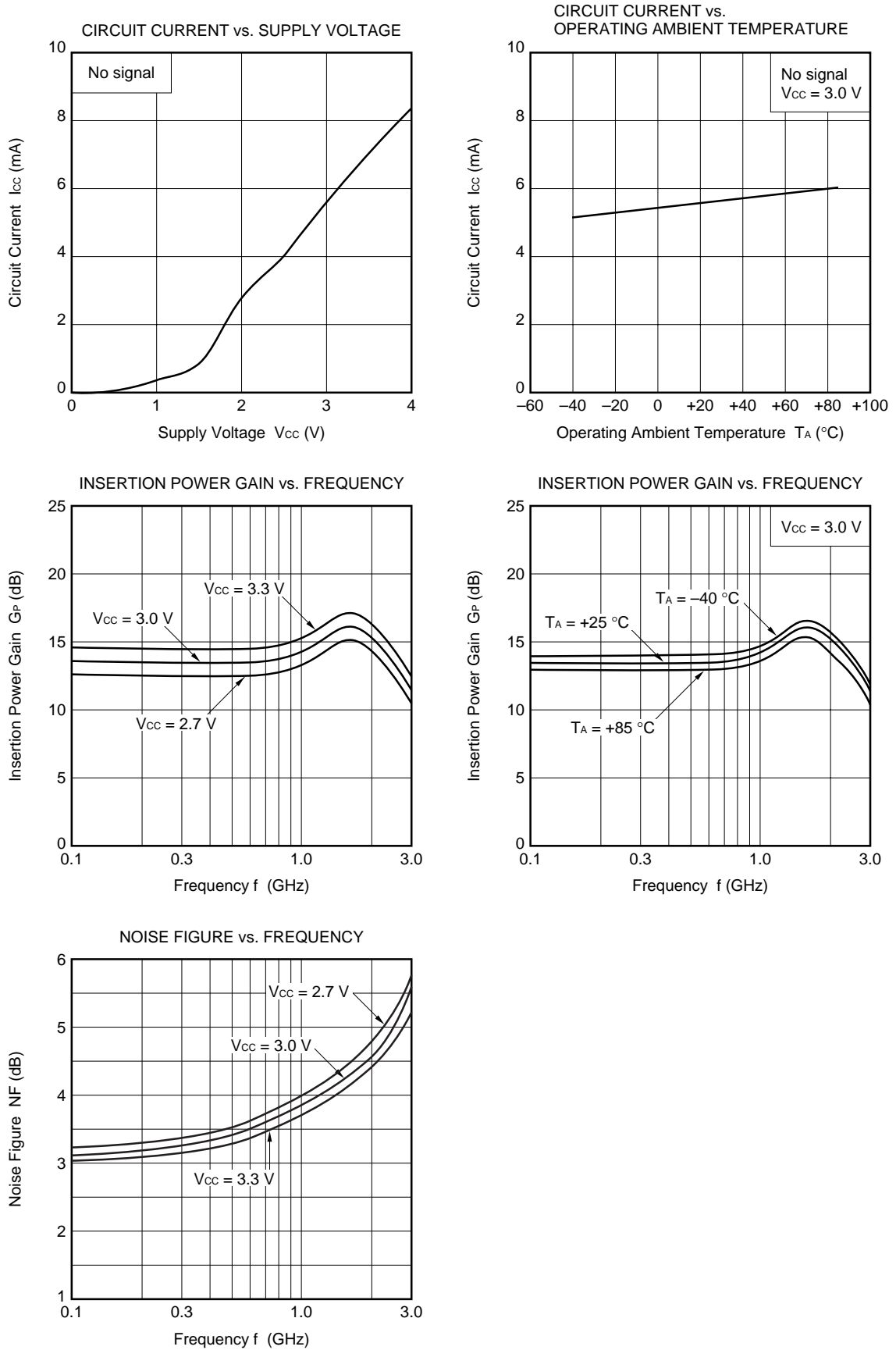

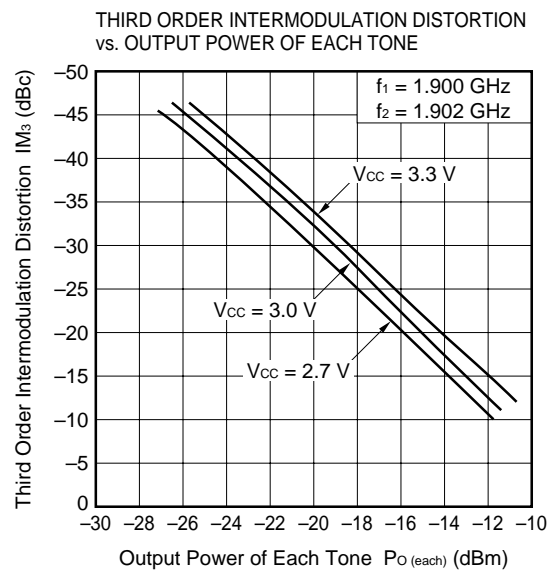
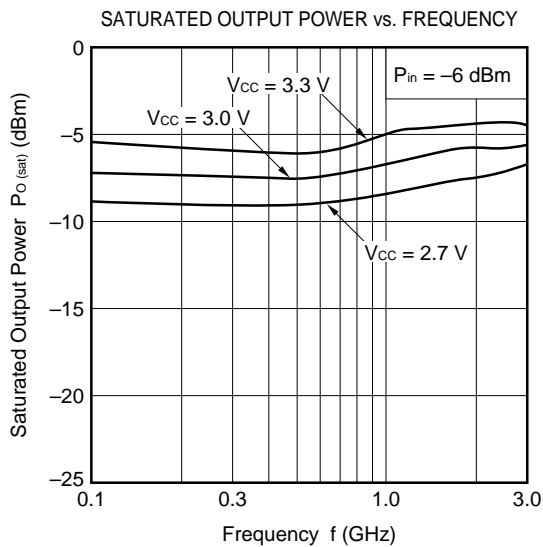
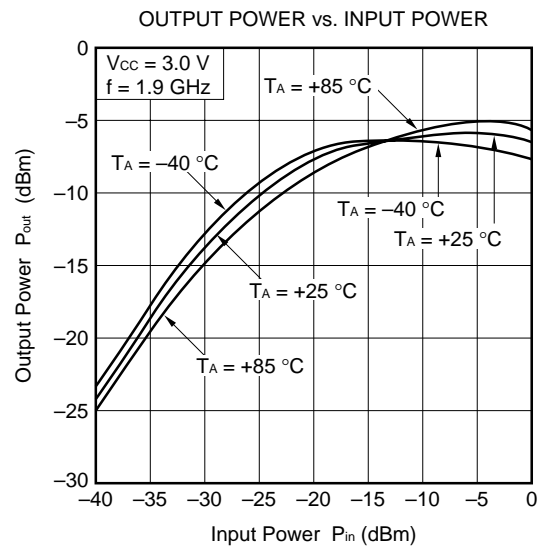
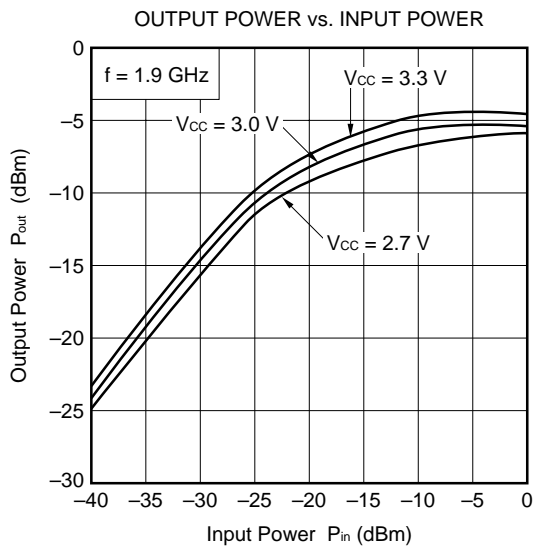
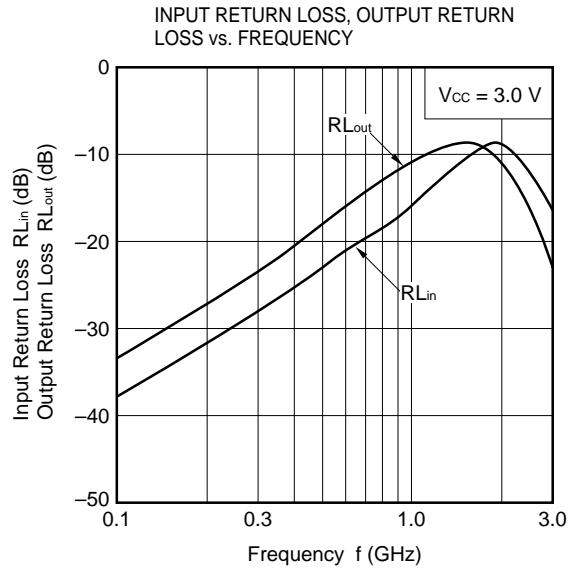
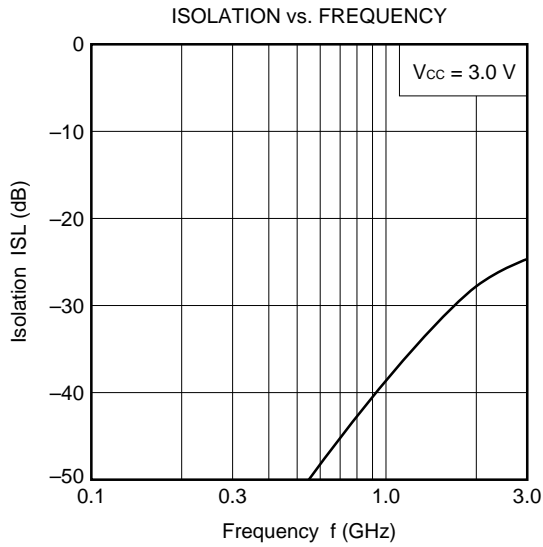

★ S-PARAMETER ($T_A = +25\text{ }^\circ\text{C}$, $V_{CC} = 3.0\text{ V}$)

S₁₁-FREQUENCY

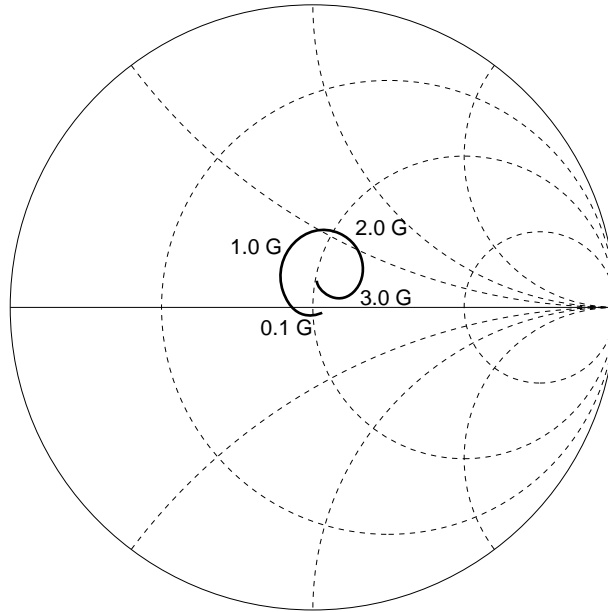

S₂₂-FREQUENCY

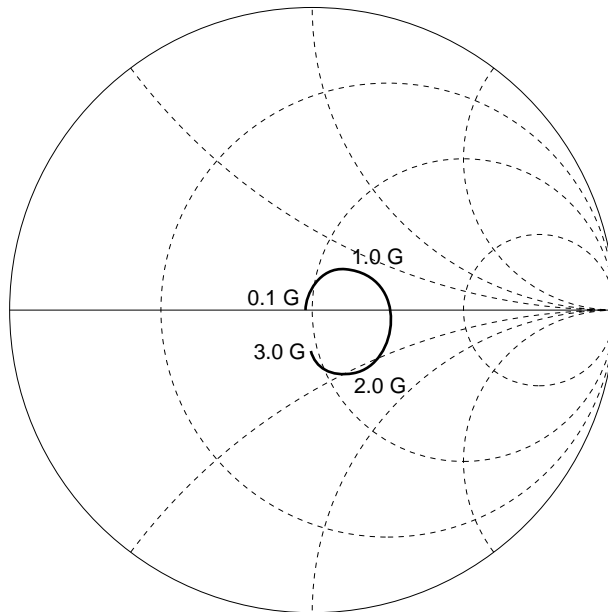

TYPICAL S-PARAMETER VALUES (T_A = +25 °C)

μPC2749TB

V_{CC} = 3.0 V, I_{CC} = 6.5 mA

FREQUENCY MHz	S ₁₁		S ₂₁		S ₁₂		S ₂₂		K
	MAG	ANG	MAG	ANG	MAG	ANG	MAG	ANG	
100.0000	0.021	13.0	4.096	-1.9	0.002	-1.1	0.024	165.8	66.82
200.0000	0.038	-30.5	4.216	-7.8	0.001	75.4	0.033	113.6	129.26
300.0000	0.034	-71.8	4.282	-15.5	0.001	141.5	0.064	96.1	90.16
400.0000	0.052	-120.5	4.403	-21.0	0.002	129.9	0.080	87.9	45.30
500.0000	0.062	-149.9	4.390	-26.6	0.002	134.1	0.103	76.9	57.58
600.0000	0.079	-169.7	4.399	-31.6	0.003	128.3	0.127	68.6	34.08
700.0000	0.097	173.6	4.566	-36.7	0.005	132.9	0.151	60.6	22.08
800.0000	0.116	160.5	4.667	-41.3	0.007	131.5	0.174	53.7	14.70
900.0000	0.134	149.3	4.843	-46.8	0.008	129.3	0.197	44.9	12.29
1000.0000	0.156	138.8	5.016	-52.6	0.009	124.6	0.220	36.1	10.00
1100.0000	0.178	128.5	5.305	-60.3	0.014	131.4	0.240	28.0	6.15
1200.0000	0.195	118.7	5.660	-67.1	0.016	122.5	0.262	17.3	5.13
1300.0000	0.214	108.7	5.835	-76.2	0.020	118.6	0.279	8.6	3.80
1400.0000	0.229	99.5	6.148	-84.5	0.022	114.4	0.287	-2.0	3.23
1500.0000	0.249	89.4	6.364	-93.8	0.025	107.7	0.294	-13.5	2.72
1600.0000	0.259	79.9	6.611	-103.6	0.028	104.3	0.294	-23.6	2.35
1700.0000	0.264	69.8	6.577	-113.5	0.032	96.8	0.283	-33.8	2.09
1800.0000	0.259	60.3	6.549	-123.4	0.034	91.8	0.272	-44.1	1.99
1900.0000	0.248	50.9	6.407	-132.9	0.036	83.3	0.256	-53.8	1.97
2000.0000	0.238	43.6	6.321	-140.8	0.037	78.5	0.234	-61.4	1.99
2100.0000	0.218	35.9	6.046	-148.8	0.038	75.1	0.213	-69.5	2.04
2200.0000	0.204	30.1	5.862	-156.5	0.039	70.4	0.193	-73.8	2.08
2300.0000	0.183	25.3	5.696	-163.2	0.040	68.3	0.174	-79.5	2.15
2400.0000	0.156	21.2	5.430	-170.5	0.041	60.7	0.164	-84.1	2.25
2500.0000	0.140	18.8	5.282	-176.3	0.042	61.6	0.152	-82.1	2.25
2600.0000	0.119	18.7	5.013	177.2	0.040	58.1	0.142	-84.5	2.53
2700.0000	0.095	21.2	4.849	170.9	0.042	55.1	0.146	-85.5	2.46
2800.0000	0.078	30.0	4.596	164.9	0.042	51.9	0.149	-83.9	2.62
2900.0000	0.066	44.5	4.446	158.1	0.042	44.7	0.154	-91.8	2.70
3000.0000	0.070	66.0	4.163	152.3	0.044	41.9	0.171	-92.8	2.73
3100.0000	0.082	78.1	3.966	145.3	0.042	37.1	0.181	-99.6	2.97

PACAGE DIMENSIONS

6 pin super minimold (Unit: mm)

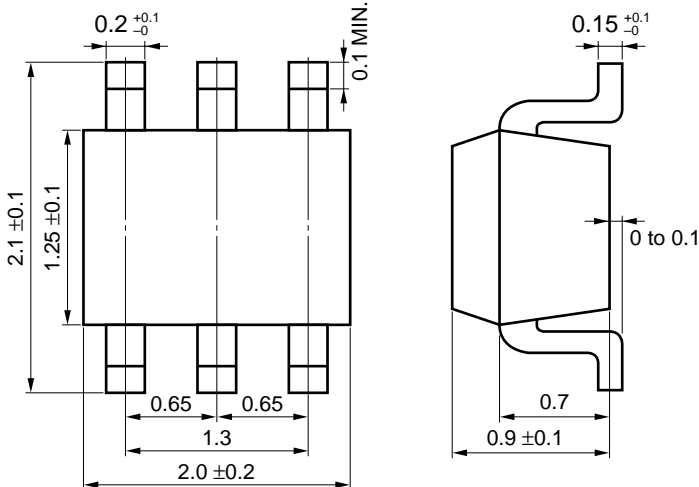

NOTES ON CORRECT USE

- (1) Observe precautions for handling because of electro-static sensitive devices.
- (2) Form a ground pattern as wide as possible to minimize ground impedance (to prevent undesired oscillation).
All the ground pins must be connected together with wide ground pattern to decrease impedance difference.
- (3) The bypass capacitor should be attached to Vcc line.
- (4) The DC cut capacitor must be attached to input pin.

RECOMMENDED SOLDERING CONDITIONS

This product should be soldered under the following recommended conditions. For soldering methods and conditions other than those recommended below, contact your NEC sales representative.

Soldering Method	Soldering Conditions	Recommended Condition Symbol
Infrared Reflow	Package peak temperature: 235 °C or below Time: 30 seconds or less (at 210 °C) Count: 3, Exposure limit: None ^{Note}	IR35-00-3
VPS	Package peak temperature: 215 °C or below Time: 40 seconds or less (at 200 °C) Count: 3, Exposure limit: None ^{Note}	VP15-00-3
Wave Soldering	Soldering bath temperature: 260 °C or below Time: 10 seconds or less Count: 1, Exposure limit: None ^{Note}	WS60-00-1
Partial Heating	Pin temperature: 300 °C Time: 3 seconds or less (per side of device) Exposure limit: None ^{Note}	—

Note After opening the dry pack, keep it in a place below 25 °C and 65 % RH for the allowable storage period.

Caution Do not use different soldering methods together (except for partial heating).

For details of recommended soldering conditions for surface mounting, refer to information document SEMICONDUCTOR DEVICE MOUNTING TECHNOLOGY MANUAL (C10535E).

[MEMO]

[MEMO]

[MEMO]

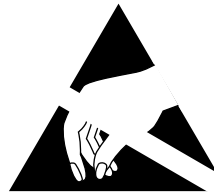

ATTENTION

OBSERVE PRECAUTIONS
FOR HANDLING
ELECTROSTATIC
SENSITIVE
DEVICES

NESAT (NEC Silicon Advanced Technology) is a trademark of NEC Corporation.

- **The information in this document is subject to change without notice. Before using this document, please confirm that this is the latest version.**
 - No part of this document may be copied or reproduced in any form or by any means without the prior written consent of NEC Corporation. NEC Corporation assumes no responsibility for any errors which may appear in this document.
 - NEC Corporation does not assume any liability for infringement of patents, copyrights or other intellectual property rights of third parties by or arising from use of a device described herein or any other liability arising from use of such device. No license, either express, implied or otherwise, is granted under any patents, copyrights or other intellectual property rights of NEC Corporation or others.
 - Descriptions of circuits, software, and other related information in this document are provided for illustrative purposes in semiconductor product operation and application examples. The incorporation of these circuits, software, and information in the design of the customer's equipment shall be done under the full responsibility of the customer. NEC Corporation assumes no responsibility for any losses incurred by the customer or third parties arising from the use of these circuits, software, and information.
 - While NEC Corporation has been making continuous effort to enhance the reliability of its semiconductor devices, the possibility of defects cannot be eliminated entirely. To minimize risks of damage or injury to persons or property arising from a defect in an NEC semiconductor device, customers must incorporate sufficient safety measures in its design, such as redundancy, fire-containment, and anti-failure features.
 - NEC devices are classified into the following three quality grades:
"Standard", "Special", and "Specific". The Specific quality grade applies only to devices developed based on a customer designated "quality assurance program" for a specific application. The recommended applications of a device depend on its quality grade, as indicated below. Customers must check the quality grade of each device before using it in a particular application.
 - Standard: Computers, office equipment, communications equipment, test and measurement equipment, audio and visual equipment, home electronic appliances, machine tools, personal electronic equipment and industrial robots
 - Special: Transportation equipment (automobiles, trains, ships, etc.), traffic control systems, anti-disaster systems, anti-crime systems, safety equipment and medical equipment (not specifically designed for life support)
 - Specific: Aircraft, aerospace equipment, submersible repeaters, nuclear reactor control systems, life support systems or medical equipment for life support, etc.
- The quality grade of NEC devices is "Standard" unless otherwise specified in NEC's Data Sheets or Data Books. If customers intend to use NEC devices for applications other than those specified for Standard quality grade, they should contact an NEC sales representative in advance.