

FEATURES

- 7 dBm P_{1dB} TYPICAL AT 1.9 GHz
- **LOW VOLTAGE:** 3 Volts
- **WIDE BANDWIDTH:** 2.9 GHz at -3 dB (UPC2762T)
- **HIGH GAIN:** 20 dB at 1.9 GHz (UPC2763T)
- **SUPER SMALL PACKAGE**
- **TAPE AND REEL PACKAGING OPTION AVAILABLE**

DESCRIPTION

The UPC2762T and UPC2763T are Silicon Monolithic integrated circuits which are manufactured using the NESAT III process. The NESAT III process produces transistors with f_t approaching 20 GHz. These amplifiers were designed for 900 MHz and 1.9 GHz receivers in cellular, cordless telephone and PCN applications. Operating on a 3 volt supply these ICs are ideally suited for hand-held, portable designs.

NEC's stringent quality assurance and test procedures ensure the highest reliability and performance.

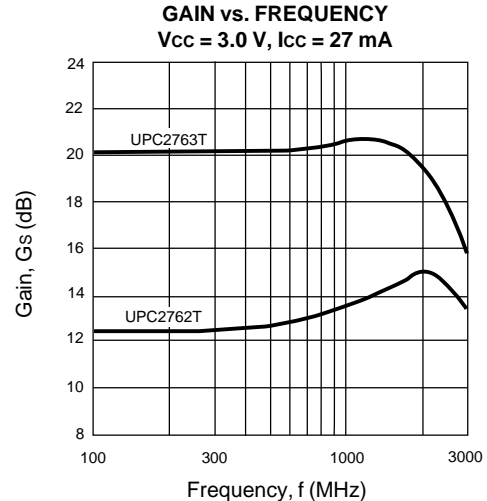

ELECTRICAL CHARACTERISTICS (T_A = 25°C, Z_L = Z_S = 50Ω, V_{CC} = 3.0 V)

PART NUMBER PACKAGE OUTLINE			UPC2762T T06			UPC2763T T06		
SYMBOLS	PARAMETERS AND CONDITIONS	UNITS	MIN	TYP	MAX	MIN	TYP	MAX
I _{CC}	Circuit Current (no signal)	mA		27	35		27	35
G _s	Small Signal Gain, f = 900 MHz f = 1900 MHz	dB dB	11 11.5	13 14.5	16 17.5	16 16.5	20 19.5	23 22.5
f _u ¹	Upper Limit Operating Frequency (The gain at f _u is 3 dB down from the gain at 0.1 GHz)	GHz	2.7	2.9		2.0	2.4	
P _{1dB}	Output Power at 1 dB Compression Point, f = 900 MHz f = 1900 MHz	dBm dBm	+5.5 +4.5	+8 +7		+7 +4	+9.5 +6.5	
P _{SAT}	Saturated Output Power, f = 900 MHz f = 1900 MHz	dBm dBm		9 8.5			11 8	
NF	Noise Figure, f = 900 MHz f = 1900 MHz	dB dB		6.5 7	8 8.5		5.5 5.5	7.0 7.0
RL _{IN}	Input Return Loss, f = 900 MHz f = 1900 MHz	dB dB	6 5.5	9 8.5		8 9	11 12	
RL _{OUT}	Output Return Loss, f = 900 MHz f = 1900 MHz	dB dB	8 9	11 12		5 6	8 9	
ISOL	Isolation, f = 900 MHz f = 1900 MHz	dB dB	22 20	27 25		25 24	30 29	
OIP3	SSB Output Third Order Intercept Point f = 900, 902 MHz f = 1900, 1902 MHz	dBm dBm		+12 +9			+17 +11	
R _{TH} (J-A)	Thermal Resistance (Junction to Ambient) Free Air Mounted on a 50 x 50 x 1.6 mm epoxy glass PWB	°C/W °C/W			620 230			620 230

Note:

1. The gain at f_u is 3 dB down from the gain at 100 MHz.

UPC2762T, UPC2763T

ABSOLUTE MAXIMUM RATINGS¹ (T_A = 25°C)

SYMBOLS	PARAMETERS	UNITS	RATINGS
V _{CC}	Supply Voltage	V	3.6
I _{CC}	Total Supply Current	mA	70
P _{IN}	Input Power	dBm	+10
P _T	Total Power Dissipation ²	mW	280
T _{OP}	Operating Temperature	°C	-40 to +85
T _{STG}	Storage Temperature	°C	-55 to +150

Notes:

1. Operation in excess of any one of these parameters may result in permanent damage.
2. Mounted on a 50 x 50 x 1.6 mm epoxy glass PWB (T_A = 85°C).

RECOMMENDED OPERATING CONDITIONS

SYMBOLS	PARAMETERS	UNITS	MIN	TYP	MAX
V _{CC}	Supply Voltage	V	2.7	3	3.3
T _{OP}	Operating Temperature	°C	-40	25	85

TEST CIRCUIT

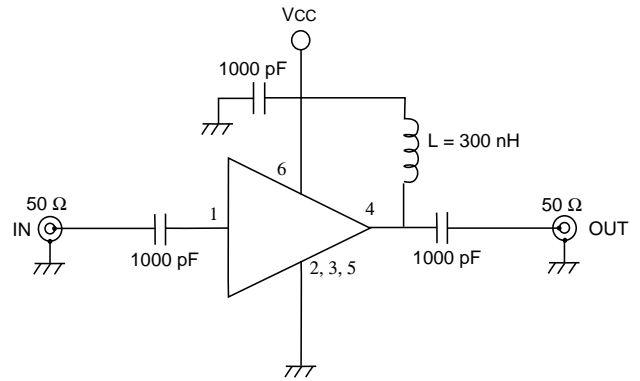

TYPICAL PERFORMANCE CURVES (T_A = 25°C)

**UPC2762T/63T
SUPPLY CURRENT vs.
SUPPLY VOLTAGE**

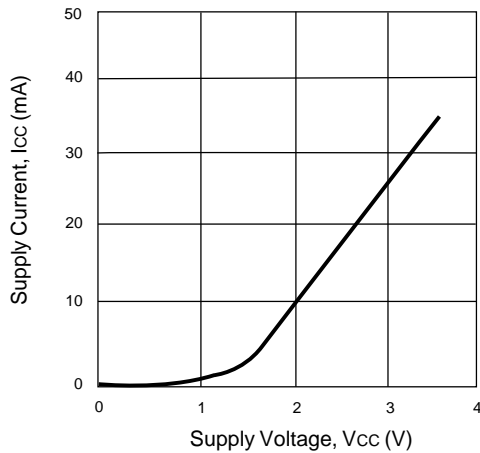

**UPC2762T/63T
SUPPLY CURRENT vs.
OPERATING TEMPERATURE**

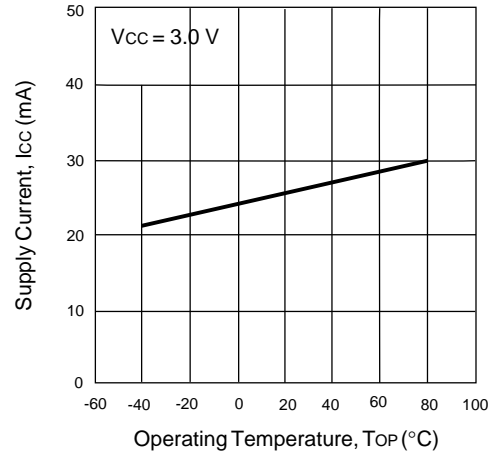

**UPC2762T
NOISE FIGURE AND GAIN vs.
FREQUENCY AND VOLTAGE**

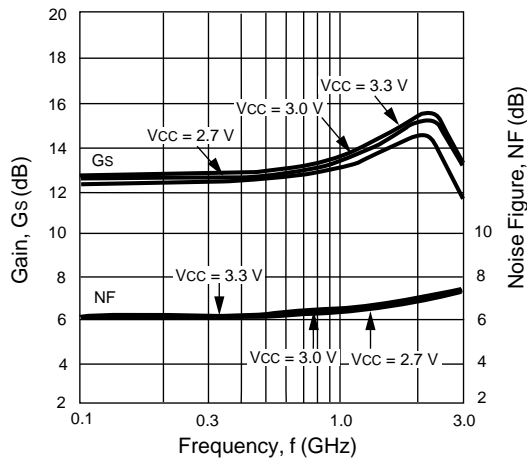

**UPC2763T
NOISE FIGURE AND GAIN vs.
FREQUENCY AND VOLTAGE**

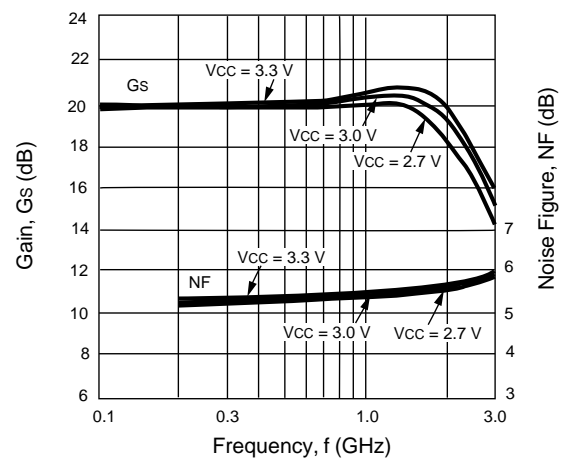

TYPICAL PERFORMANCE CURVES (TA = 25°C)

UPC2762T
GAIN vs. FREQUENCY AND TEMPERATURE

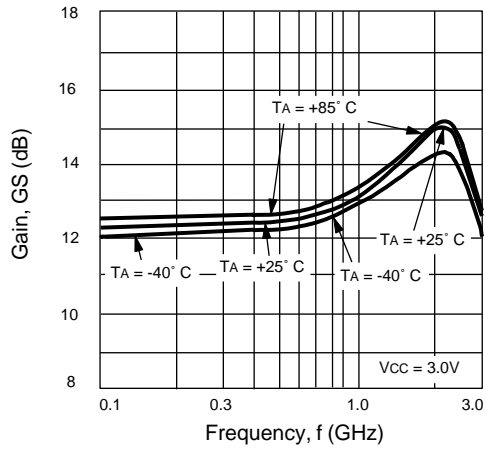

UPC2763T
GAIN vs. FREQUENCY AND TEMPERATURE

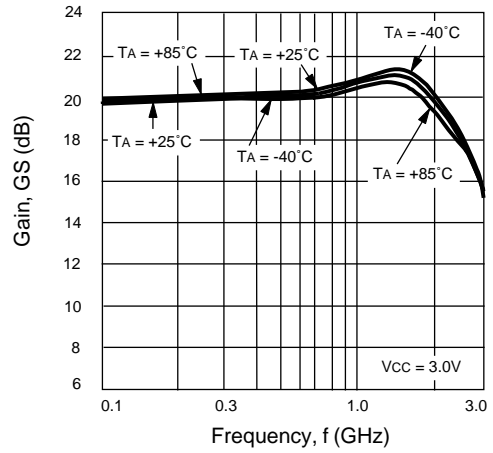

UPC2762T
INPUT AND OUTPUT
RETURN LOSS vs. FREQUENCY

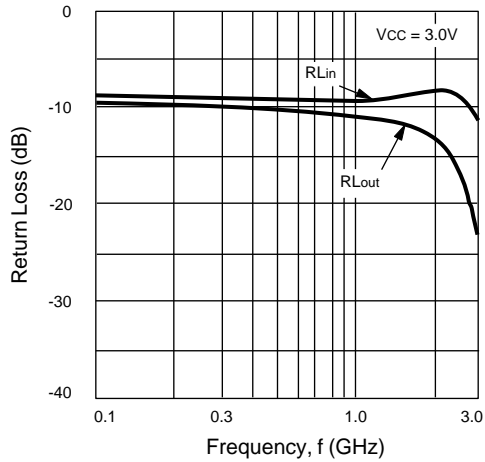

UPC2763T
INPUT AND OUTPUT
RETURN LOSS vs. FREQUENCY

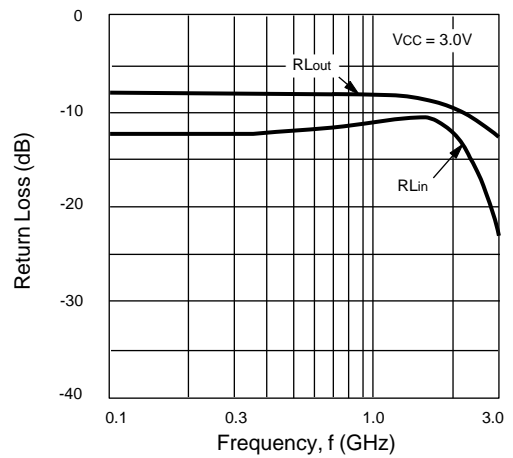

UPC2762T
ISOLATION vs. FREQUENCY

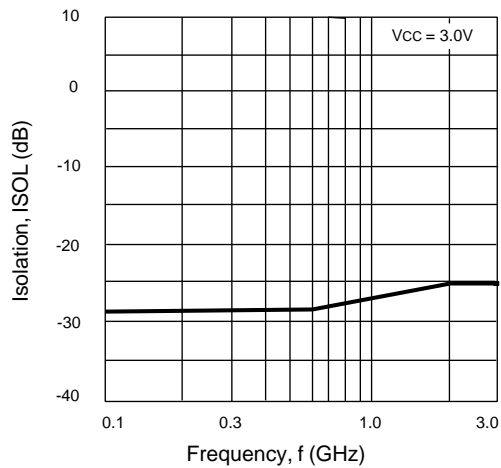

UPC2763T
ISOLATION vs. FREQUENCY

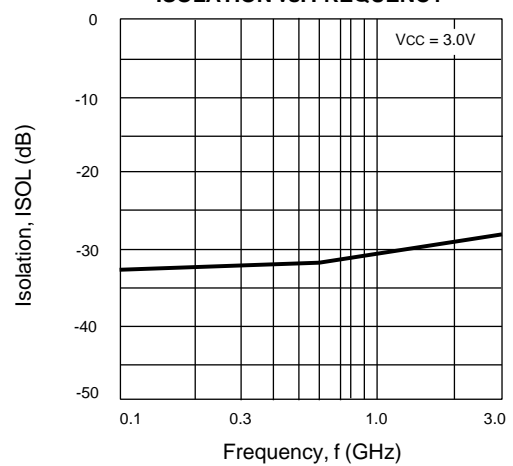

TYPICAL PERFORMANCE CURVES (TA = 25°C)

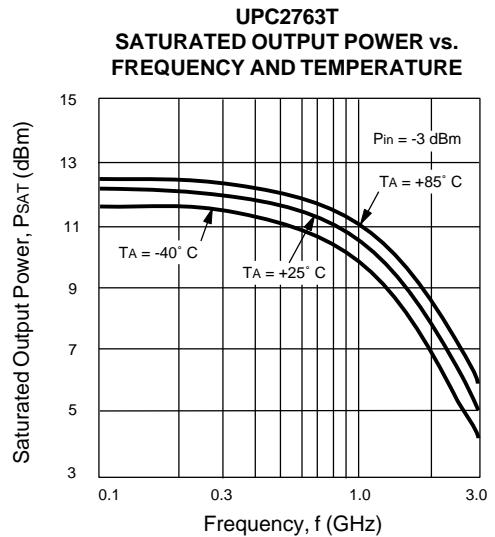
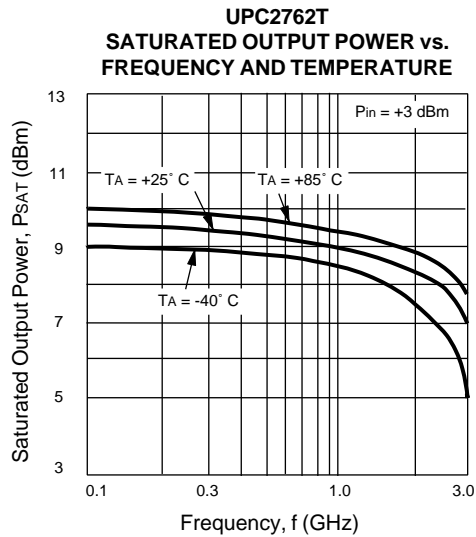
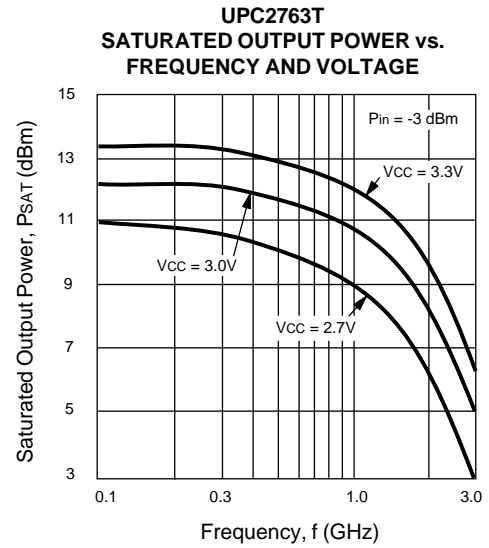
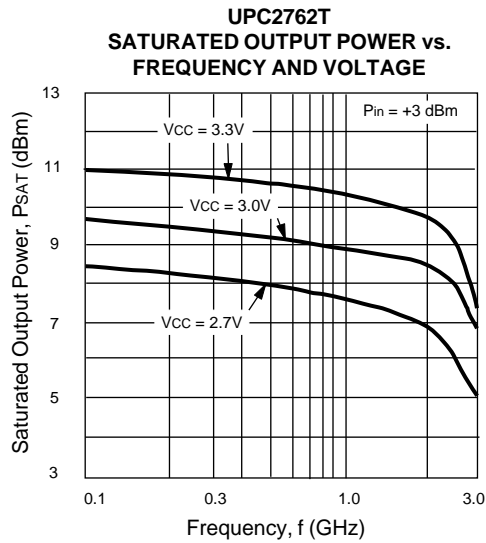
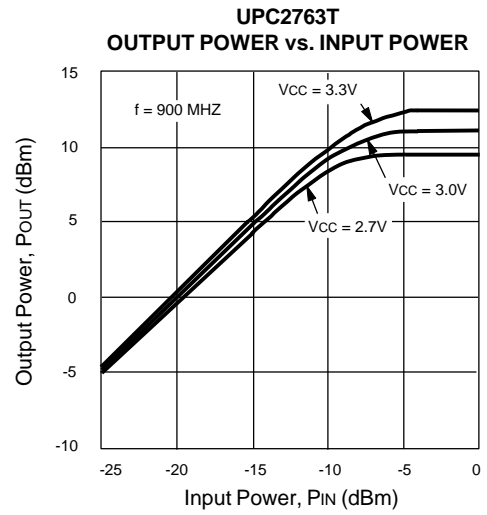
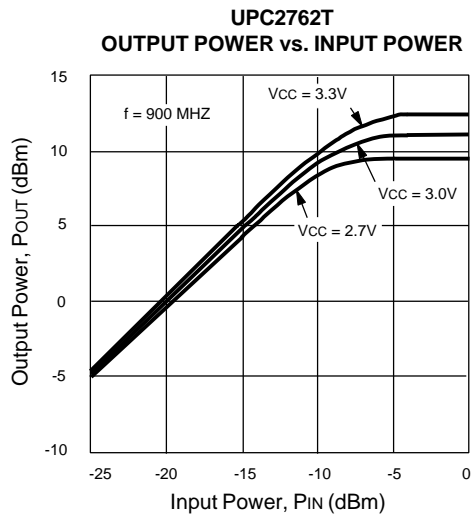

TYPICAL SCATTERING PARAMETERS (T_A = 25°C)

UPC2762T
S₁₁ vs. FREQUENCY
(V_{CC} = 3.0 V)

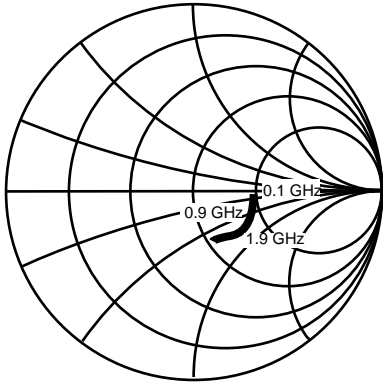

UPC2762T
S₂₂ vs. FREQUENCY
(V_{CC} = 3.0 V)

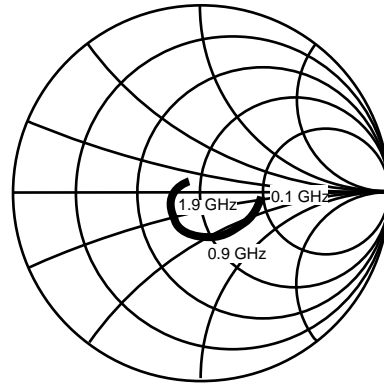

UPC2763T
S₁₁ vs. FREQUENCY
(V_{CC} = 3.0 V)

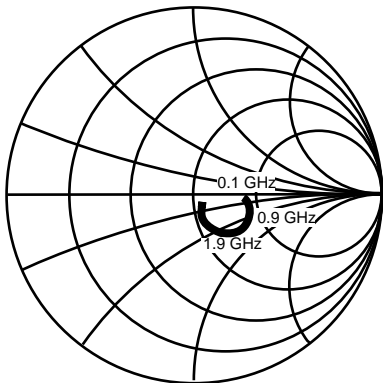

UPC2763T
S₂₂ vs. FREQUENCY
(V_{CC} = 3.0 V)

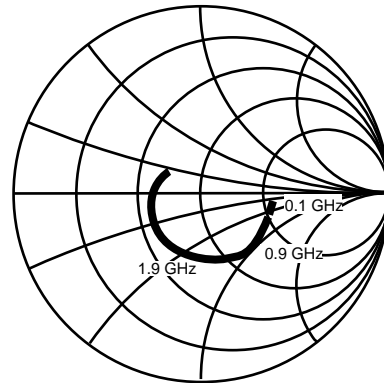

UPC2762T, UPC2763T

OUTLINE DIMENSIONS (Units in mm)

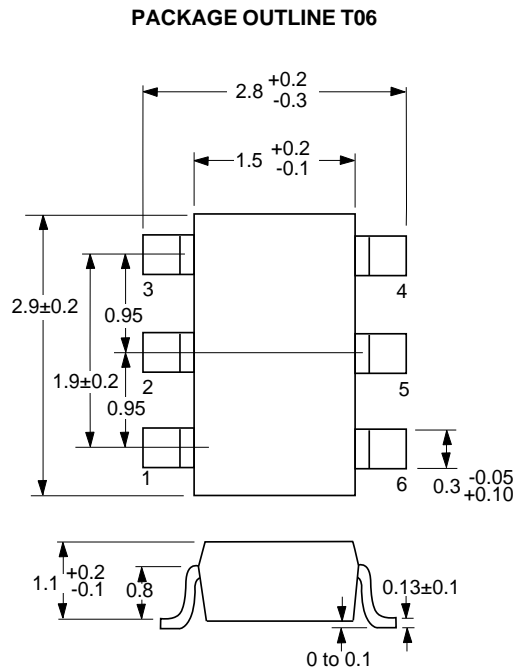

Note:
All dimensions are typical unless otherwise specified.

EQUIVALENT CIRCUIT

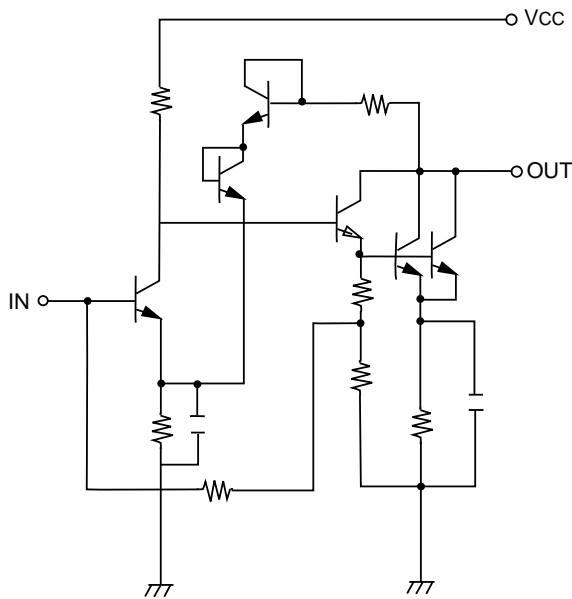

LEAD CONNECTIONS

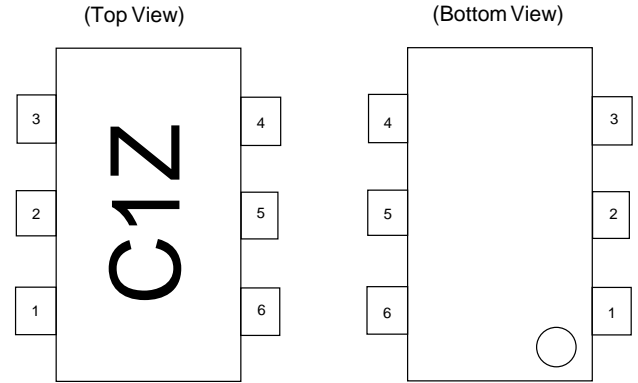

1. INPUT
2. GND
3. GND
4. OUTPUT
5. GND
6. Vcc

Note: Package Marking
C1Z: UPC2762T
C2A: UPC2763T

RECOMMENDED P.C.B. LAYOUT (Units in mm)

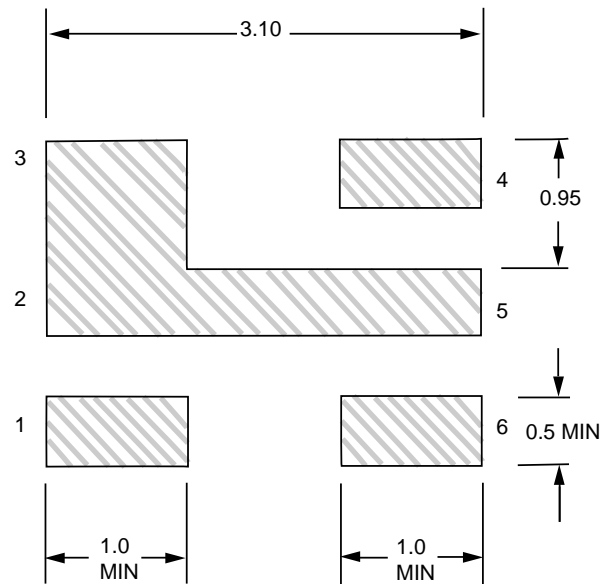

ORDERING INFORMATION

PART NUMBER	QTY
UPC2762T-E3	3K/Reel
UPC2763T-E3	3K/Reel

Note:
Embossed Tape, 8 mm wide.

EXCLUSIVE AGENT FOR **NEC Corporation** RF & MICROWAVE SEMICONDUCTOR PRODUCTS - U.S. & CANADA

CALIFORNIA EASTERN LABORATORIES, INC. ▪ Headquarters ▪ 4590 Patrick Henry Drive ▪ Santa Clara, CA 95054-1817 ▪ (408) 988-3500 ▪ Telex 34-6393/FAX (408) 988-0279
DATA SUBJECT TO CHANGE WITHOUT NOTICE