



3 V, SUPER MINIMOLD MEDIUM POWER SI MMIC AMPLIFIER

UPC2762TB

FEATURES

- **HIGH P_{1dB}**: 7 dBm TYP at 1.9 GHz
- **LOW VOLTAGE**: 3.0 V TYP, 2.7 V MIN
- **WIDE BANDWIDTH**: 2.9 GHz at -3 dB
- **SUPER SMALL PACKAGE**: SOT-363 package
- **TAPE AND REEL PACKAGING OPTION AVAILABLE**

DESCRIPTION

NEC's UPC2762TB is a Silicon Monolithic integrated circuit which is manufactured using the NESAT™ III process. The NESAT™ III process produces transistors with f_t approaching 20 GHz. The UPC2762TB is pin compatible and has comparable performance to the larger UPC2762T, so it is suitable for use as a replacement to help reduce system size. The IC is housed in a 6 pin super minimold or SOT-363 package. Operating on a 3 volt supply, this IC is ideally suited for handheld, portable designs.

NEC's stringent quality assurance and test procedures ensure the highest reliability and performance.

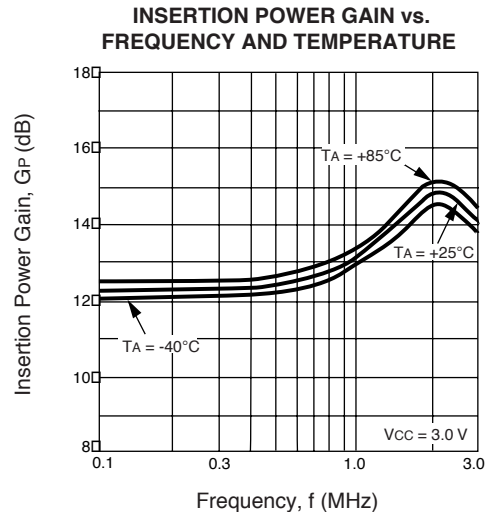

ELECTRICAL CHARACTERISTICS (TA = 25°C, Z_L = Z_S = 50Ω, V_{CC} = 3.0 V)

PART NUMBER PACKAGE OUTLINE			UPC2762TB S06		
SYMBOLS	PARAMETERS AND CONDITIONS	UNITS	MIN	TYP	MAX
I _{CC}	Circuit Current (no signal)	mA		27	35
G _S	Small Signal Gain, f = 900 MHz	dB	11	13	16
	f = 1900 MHz	dB	11.5	15.5	17.5
f _U	Upper Limit Operating Frequency (The gain at f _U is 3 dB down from the gain at 0.1 GHz)	GHz	2.7	2.9	
P _{1dB}	Output Power at 1 dB Compression Point, f = 900 MHz	dBm	+5.5	+8	
	f = 1900 MHz	dBm	+4.5	+7	
P _{SAT}	Saturated Output Power, f = 900 MHz	dBm		9	
	f = 1900 MHz	dBm		8.5	
NF	Noise Figure, f = 900 MHz	dB		6.5	8.0
	f = 1900 MHz	dB		7	9.0
RL _{IN}	Input Return Loss, f = 900 MHz	dB	6	9	
	f = 1900 MHz	dB	5.5	8.5	
RL _{OUT}	Output Return Loss, f = 900 MHz	dB	8	11	
	f = 1900 MHz	dB	9	12	
ISOL	Isolation, f = 900 MHz	dB	22	27	
	f = 1900 MHz	dB	20	25	
OIP ₃	SSB Output Third Order Intercept Point P _{OUT} = +4 dBm	dBm		+12	
	f = 900, 902 MHz	dBm		+9	
	f = 1900, 1902 MHz	dBm			
P _{ADJ}	Adjacent Channel Power, Δf = ±50 KHz	dBc		-64	
	f = 900 MHz, π/4 QPSK wave ¹ , Δf = ±100 KHz	dBc		-64	
	P _O = +4 dBm				

Note:

1. π/4 QPSK modulated wave input, data rate 42 kbps.

ABSOLUTE MAXIMUM RATINGS¹ (T_A = 25°C)

SYMBOLS	PARAMETERS	UNITS	RATINGS
V _{CC}	Supply Voltage	V	3.6
I _{CC}	Total Supply Current	mA	70
P _{IN}	Input Power	dBm	+10
P _T	Total Power Dissipation ²	mW	200
T _{OP}	Operating Temperature	°C	-40 to +85
T _{STG}	Storage Temperature	°C	-55 to +150

Notes:

1. Operation in excess of any one of these parameters may result in permanent damage.
2. Mounted on a 50 x 50 x 1.6 mm epoxy glass PWB (T_A = 85°C).

RECOMMENDED OPERATING CONDITIONS

SYMBOLS	PARAMETERS	UNITS	MIN	TYP	MAX
V _{CC}	Supply Voltage	V	2.7	3	3.3
T _{OP}	Operating Temperature	°C	-40	25	85

TEST CIRCUIT

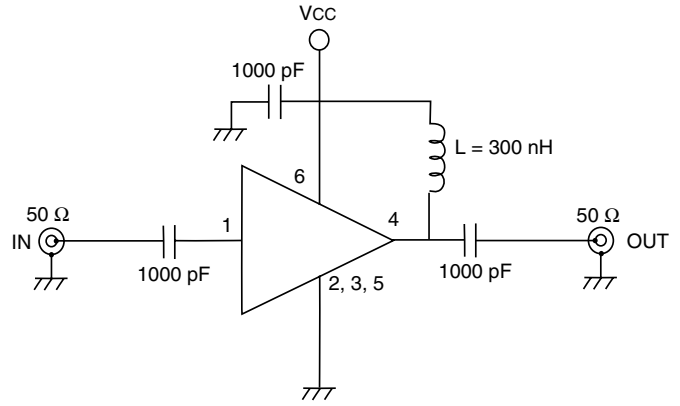

TYPICAL PERFORMANCE CURVES (T_A = 25°C)

CIRCUIT CURRENT vs. SUPPLY VOLTAGE

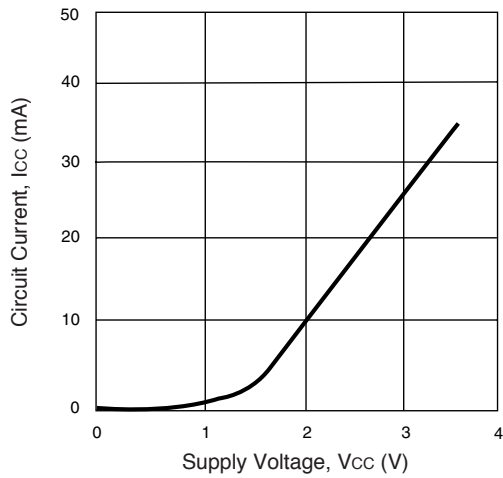

CIRCUIT CURRENT vs. OPERATING TEMPERATURE

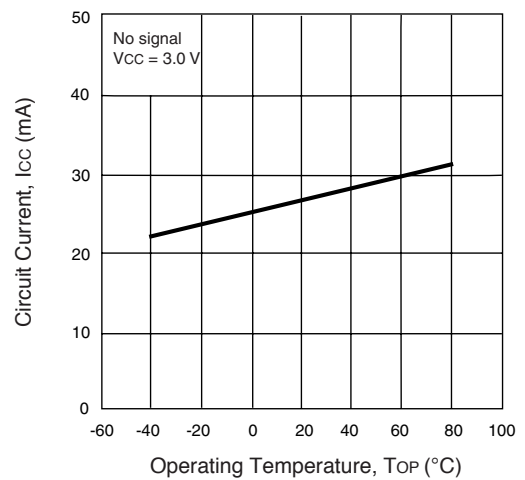

NOISE FIGURE AND INSERTION POWER GAIN vs. FREQUENCY AND VOLTAGE

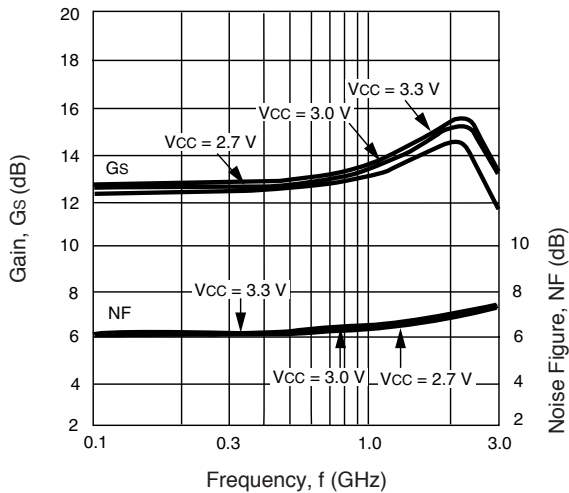

INPUT AND OUTPUT RETURN LOSS vs. FREQUENCY

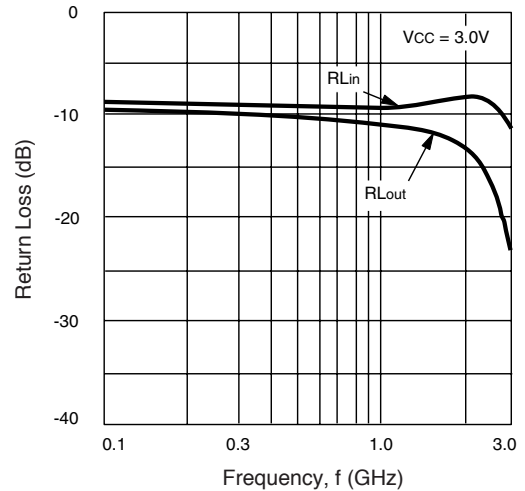

TYPICAL PERFORMANCE CURVES ($T_A = 25^\circ\text{C}$)

ISOLATION vs. FREQUENCY

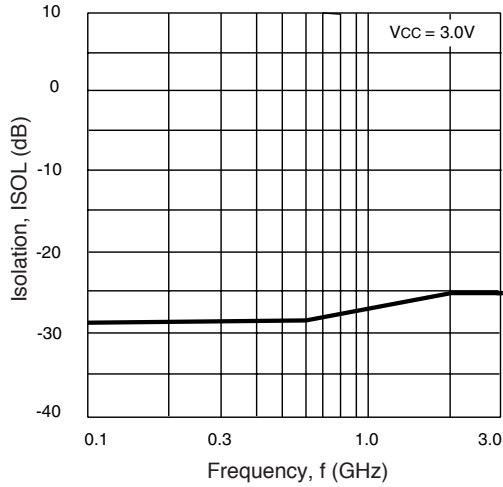

OUTPUT POWER vs. INPUT POWER AND VOLTAGE

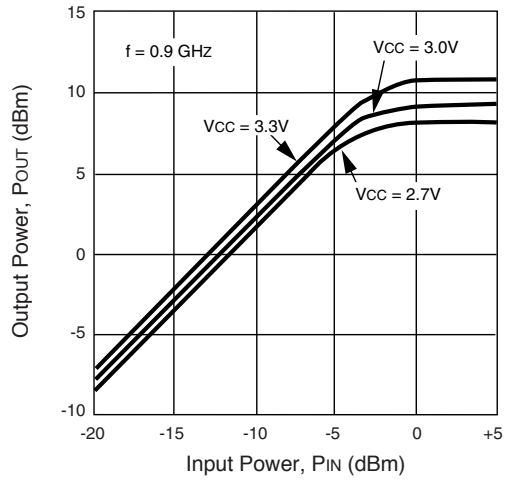

OUTPUT POWER vs. INPUT POWER AND TEMPERATURE

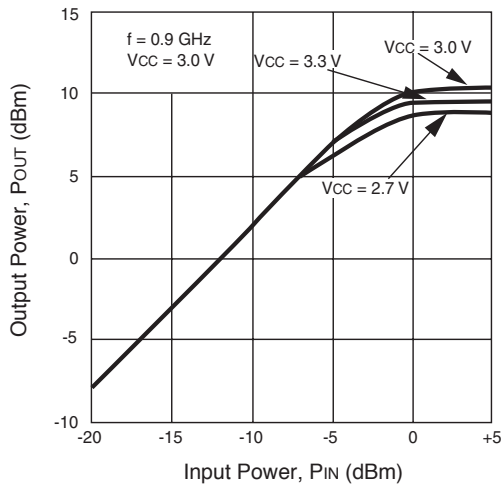

OUTPUT POWER vs. INPUT POWER AND VOLTAGE

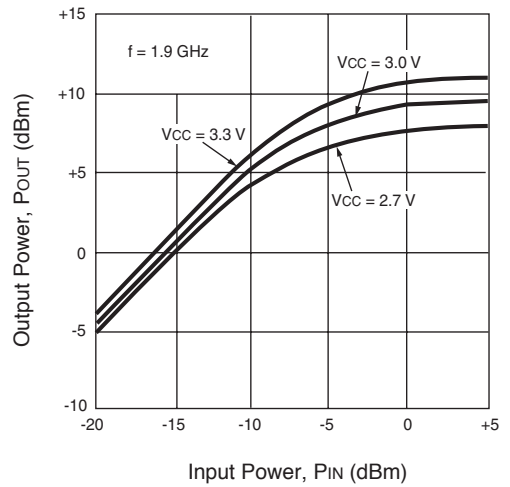

OUTPUT POWER vs. INPUT POWER AND TEMPERATURE

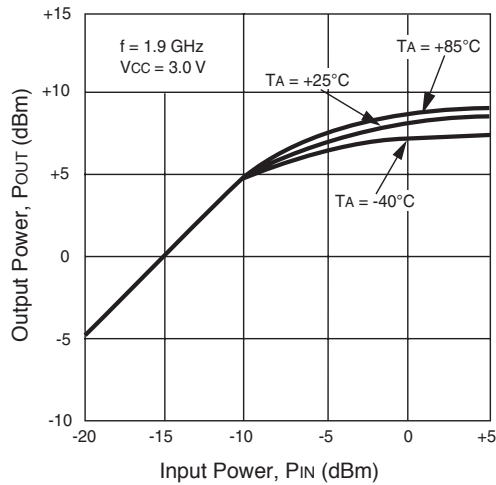

SATURATED OUTPUT POWER vs. FREQUENCY

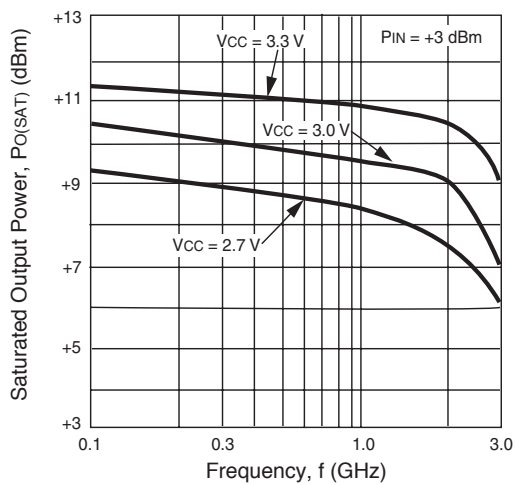

TYPICAL PERFORMANCE CURVES ($T_A = 25^\circ\text{C}$)

SATURATED OUTPUT POWER vs. FREQUENCY AND TEMPERATURE

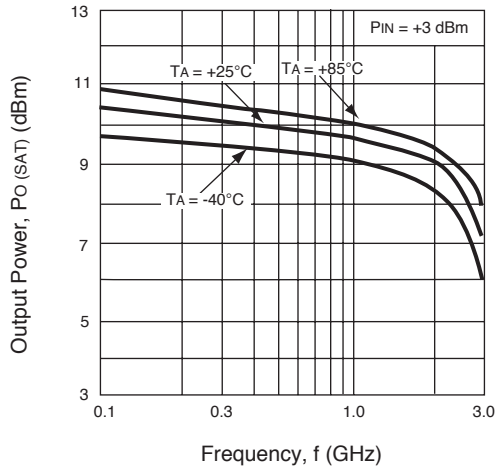

THIRD ORDER INTERMODULATION DISTORTION vs. OUTPUT POWER OF EACH TONE AND VOLTAGE

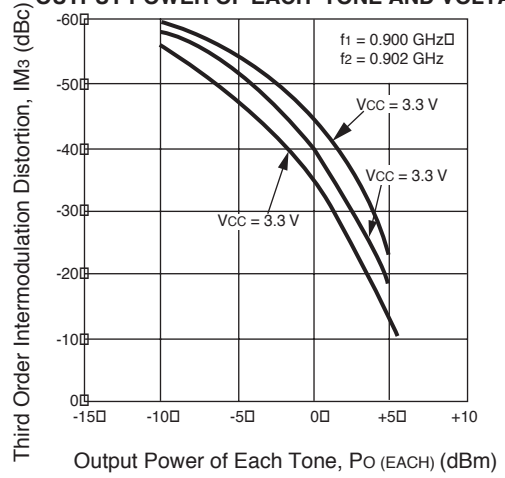

THIRD ORDER INTERMODULATION DISTORTION vs. OUTPUT POWER OF EACH TONE AND VOLTAGE

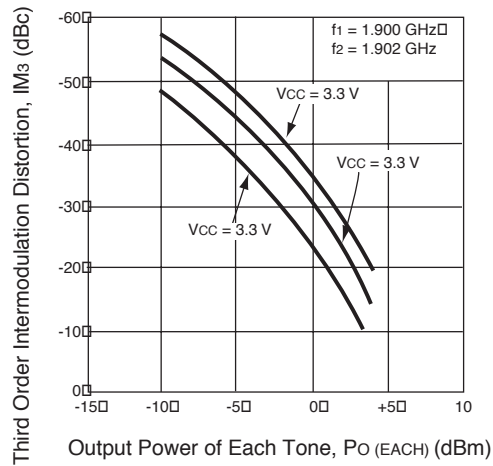

TYPICAL SCATTERING PARAMETERS ($T_A = +25^\circ\text{C}$, $V_{CC} = V_{OUT} = 3.0\text{ V}$)

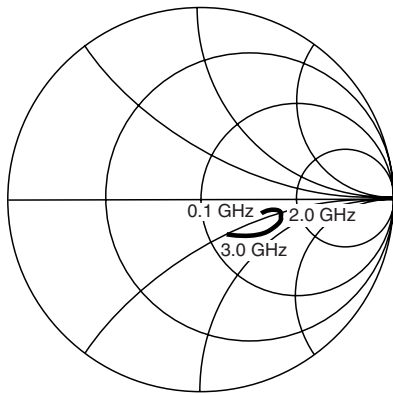

S11

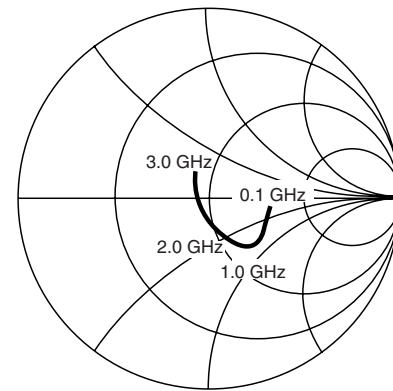

S22

$V_{CC} = V_{OUT} = 3.0\text{ V}$, $I_{CC} = 29\text{ mA}$

FREQUENCY GHz	S11		S21		S12		S22		K
	MAG	ANG	MAG	ANG	MAG	ANG	MAG	ANG	
0.1	0.338	-1.3	4.560	-3.4	0.039	1.0	0.310	-5.5	2.23
0.2	0.346	-2.0	4.581	-7.6	0.039	2.7	0.311	-9.5	2.20
0.3	0.348	-1.2	4.616	-11.3	0.039	6.8	0.302	-12.3	2.20
0.4	0.340	-1.9	4.661	-15.8	0.040	8.1	0.296	-16.2	2.18
0.5	0.329	-3.1	4.689	-19.5	0.040	11.6	0.290	-20.2	2.20
0.6	0.324	-6.2	4.726	-23.6	0.041	13.7	0.292	-24.1	2.12
0.7	0.341	-8.1	4.844	-27.4	0.042	15.8	0.291	-26.2	2.01
0.8	0.359	-7.6	4.927	-31.5	0.043	18.1	0.292	-28.3	1.90
0.9	0.378	-6.5	5.057	-35.8	0.044	19.3	0.284	-30.9	1.77
1.0	0.375	-5.1	5.179	-41.0	0.045	20.3	0.280	-35.3	1.72
1.1	0.363	-5.2	5.306	-45.9	0.047	22.1	0.285	-40.0	1.64
1.2	0.353	-6.7	5.400	-51.0	0.047	23.7	0.288	-43.4	1.62
1.3	0.357	-8.8	5.567	-56.5	0.048	26.1	0.288	-45.7	1.54
1.4	0.377	-11.7	5.706	-61.7	0.049	24.5	0.285	-47.9	1.44
1.5	0.402	-12.7	5.820	-68.0	0.052	26.7	0.282	-52.8	1.32
1.6	0.414	-13.2	5.987	-73.7	0.052	26.8	0.285	-58.1	1.27
1.7	0.426	-13.6	6.081	-80.1	0.055	29.0	0.288	-62.0	1.18
1.8	0.434	-16.1	6.182	-86.7	0.056	28.2	0.291	-66.1	1.14
1.9	0.448	-19.0	6.229	-93.2	0.057	28.5	0.286	-70.4	1.09
2.0	0.463	-21.7	6.328	-99.7	0.057	28.0	0.282	-76.2	1.07
2.1	0.483	-23.9	6.382	-106.7	0.058	28.5	0.282	-81.5	1.01
2.2	0.492	-25.8	6.431	-113.8	0.058	29.0	0.282	-86.9	0.99
2.3	0.492	-29.7	6.424	-121.2	0.060	30.1	0.278	-91.7	0.99
2.4	0.486	-34.6	6.329	-128.8	0.060	30.2	0.268	-98.4	1.01
2.5	0.489	-40.4	6.146	-136.1	0.062	31.1	0.260	-104.5	1.02
2.6	0.500	-44.6	5.997	-143.1	0.061	32.1	0.251	-111.3	1.05
2.7	0.511	-48.5	5.822	-149.9	0.064	31.4	0.248	-116.7	1.03
2.8	0.511	-50.4	5.693	-157.0	0.066	34.0	0.237	-121.5	1.04
2.9	0.494	-52.9	5.553	-163.0	0.065	33.8	0.222	-128.3	1.11
3.0	0.465	-55.9	5.334	-169.5	0.065	35.5	0.203	-134.5	1.20
3.1	0.441	-60.6	5.157	-175.5	0.066	35.5	0.189	-141.1	1.27

OUTLINE DIMENSIONS (Units in mm)

LEAD CONNECTIONS

PACKAGE OUTLINE S06

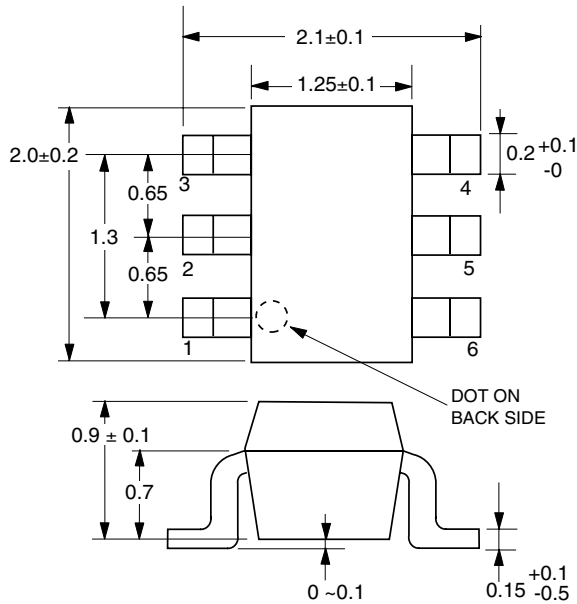

(Top View)

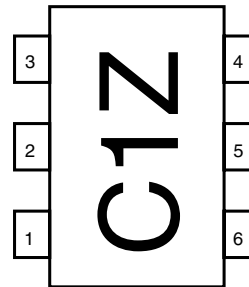

(Bottom View)

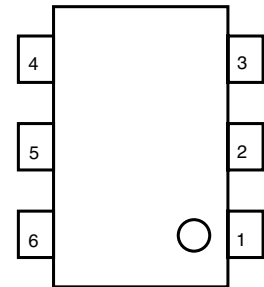

- 1. INPUT
- 2. GND
- 3. GND
- 4. OUTPUT
- 5. GND
- 6. Vcc

PIN DESCRIPTIONS

Pin No.	Pin Name	Applied Voltage (V)	Description	Internal Equivalent Circuit
1	Input	-	Signal input pin. An internal matching circuit, configured with resistors, enables 50 Ω connection over a wide bandwidth. A multi-feedback circuit is designed to cancel the deviations of hFE and resistance. This pin must be coupled to the signal source with a blocking capacitor.	
4	Output	2.7 to 3.3	Signal output pin. Connect an inductor between this pin and Vcc to supply current to the internal output transistors.	
6	Vcc		Power supply pin. This pin should be externally equipped with a bypass capacitor to minimize ground impedance.	
2 3 5	GND	0	Ground pins. These pins should be connected to system ground with minimum inductance. Ground pattern on the board should be formed as wide as possible. All the ground pins must be connected together with wide ground pattern to minimize impedance difference.	

ORDERING INFORMATION

PART NUMBER	QTY
UPC2762TB-E3-A	3K/Reel

Note:
Embossed Tape, 8 mm wide. Pins 1, 2 and 3 face perforated side of tape.

Life Support Applications

These NEC products are not intended for use in life support devices, appliances, or systems where the malfunction of these products can reasonably be expected to result in personal injury. The customers of CEL using or selling these products for use in such applications do so at their own risk and agree to fully indemnify CEL for all damages resulting from such improper use or sale.

EXCLUSIVE NORTH AMERICAN AGENT FOR **NEC** RF, MICROWAVE & OPTOELECTRONIC SEMICONDUCTORS
CEL CALIFORNIA EASTERN LABORATORIES • Headquarters • 4590 Patrick Henry Drive • Santa Clara, CA 95054-1817 • (408) 988-3500 • Telex 34-6393 • FAX (408) 988-0279
 24-Hour Fax-On-Demand: 800-390-3232 (U.S. and Canada only) • Internet: <http://WWW.CEL.COM>

Subject: Compliance with EU Directives

CEL certifies, to its knowledge, that semiconductor and laser products detailed below are compliant with the requirements of European Union (EU) Directive 2002/95/EC Restriction on Use of Hazardous Substances in electrical and electronic equipment (RoHS) and the requirements of EU Directive 2003/11/EC Restriction on Penta and Octa BDE.

CEL Pb-free products have the same base part number with a suffix added. The suffix –A indicates that the device is Pb-free. The –AZ suffix is used to designate devices containing Pb which are exempted from the requirement of RoHS directive (*). In all cases the devices have Pb-free terminals. All devices with these suffixes meet the requirements of the RoHS directive.

This status is based on CEL’s understanding of the EU Directives and knowledge of the materials that go into its products as of the date of disclosure of this information.

Restricted Substance per RoHS	Concentration Limit per RoHS (values are not yet fixed)	Concentration contained in CEL devices	
		-A	-AZ
Lead (Pb)	< 1000 PPM	Not Detected	(*)
Mercury	< 1000 PPM	Not Detected	
Cadmium	< 100 PPM	Not Detected	
Hexavalent Chromium	< 1000 PPM	Not Detected	
PBB	< 1000 PPM	Not Detected	
PBDE	< 1000 PPM	Not Detected	

If you should have any additional questions regarding our devices and compliance to environmental standards, please do not hesitate to contact your local representative.

Important Information and Disclaimer: Information provided by CEL on its website or in other communications concerning the substance content of its products represents knowledge and belief as of the date that it is provided. CEL bases its knowledge and belief on information provided by third parties and makes no representation or warranty as to the accuracy of such information. Efforts are underway to better integrate information from third parties. CEL has taken and continues to take reasonable steps to provide representative and accurate information but may not have conducted destructive testing or chemical analysis on incoming materials and chemicals. CEL and CEL suppliers consider certain information to be proprietary, and thus CAS numbers and other limited information may not be available for release.

In no event shall CEL's liability arising out of such information exceed the total purchase price of the CEL part(s) at issue sold by CEL to customer on an annual basis.

See CEL Terms and Conditions for additional clarification of warranties and liability.