

BIPOLAR ANALOG INTEGRATED CIRCUITS

μ PC2776TB

5 V, SUPER MINIMOLD SILICON MMIC MEDIUM OUTPUT POWER AMPLIFIER

DESCRIPTION

The μ PC2776TB is a silicon monolithic integrated circuits designed as wideband amplifier. This amplifier has impedance near 50Ω in HF band, so this IC suits to the system of HF to L band. This IC is packaged in super minimold package which is smaller than conventional minimold.

The μ PC2776TB has compatible pin connections and performance to the μ PC2776T of conventional minimold version. So, in the case of reducing your system size, the μ PC2776TB is suitable to replace from the μ PC2776T.

These IC is manufactured using NEC's 20 GHz f_T NESAT™ III silicon bipolar process. This process uses silicon nitride passivation film and gold electrodes. These materials can protect chip surface from external pollution and prevent corrosion/migration. Thus, this IC has excellent performance, uniformity and reliability.

FEATURES

- High-density surface mounting: 6-pin super minimold package
- Wideband response : $f_u = 2.7 \text{ GHz}_{\text{TYP. @ } 3 \text{ dB bandwidth}}$
- Medium output power : $P_o (1 \text{ dB}) = +6.5 \text{ dBm @ } f = 1 \text{ GHz with external inductor}$
- Supply voltage : $V_{CC} = 4.5 \text{ to } 5.5 \text{ V}$
- Power gain : $G_P = 23 \text{ dB}_{\text{TYP. @ } f = 1 \text{ GHz}}$
- Port impedance : input/output 50Ω

APPLICATION

- Systems required wideband operation from HF to 2.0 GHz

ORDERING INFORMATION

PART NUMBER	PACKAGE	MARKING	SUPPLYING FORM
μ PC2776TB-E3	6-pin super minimold	C2L	Embossed tape 8 mm wide. 1, 2, 3 pins face to perforation side of the tape. Qty 3 kp/reel.

Remarks To order evaluation samples, please contact your local NEC sales office. (Part number for sample order: μ PC2776TB)

Caution: Electro-static sensitive devices

PIN CONNECTIONS

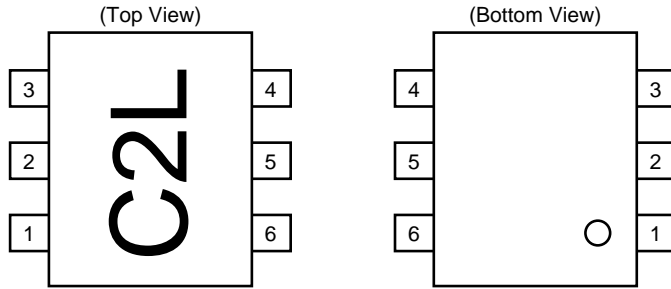

Pin NO.	Pin name
1	INPUT
2	GND
3	GND
4	OUTPUT
5	GND
6	V _{cc}

PRODUCT LINE-UP OF μPC2776 (T_A = +25 °C, V_{CC} = V_{out} = 5.0 V, Z_L = Z_s = 50 Ω)

PART NO.	f _u (GHz)	P _O (1dB) (dBm)	P _O (sat) (dBm)	G _p (dB)	NF (dB)	I _{cc} (mA)	PACKAGE	MARKING
μPC2776T	2.7	+6.5	+8.5	23	6	25	6-pin minimold	C2L
μPC2776TB							6-pin super minimold	

Remarks Typical performance. Please refer to ELECTRICAL CHARACTERISTICS in detail.

Notice The package size distinguishes between minimold and super minimold.

Selection point among product line-up

μPC2709TB: Suits to 1 GHz 2.5 GHz operation due to small inductance (e.g. 10 nH) between V_{cc} and output pin.

μPC2776TB: Suits to HF to 2.0 GHz operation due to large inductance (e.g. 100 nH) between V_{cc} and output pin.

PIN FUNCTIONS

PIN.	SYMBOL	APPLIED VOLTAGE (V)	DESCRIPTION	EQUIVALENT CIRCUIT
1	INPUT	–	High-frequency signal input pin. A internal matching circuit, configured with resistors, enables 50 Ω connection over a wide band. A multi-feedback circuit is designed to cancel the deviations of h _{FE} and resistance.	
2 3 5	GND	0	Ground pin. Form a ground pattern as wide as possible to maintain the minimum ground impedance.	
4	OUTPUT	4.5 to 5.5	High-frequency signal output pin. Connect an inductor between this pin and V _{cc} to supply current to the internal output transistors.	
6	V _{cc}		Power supply pin, which biases the internal input transistor. Excellent RF characteristics are obtained by a two-stage amplifier circuit.	

To know the associated products, please refer to each latest data sheet.

ABSOLUTE MAXIMUM RATINGS

PARAMETER	SYMBOL	CONDITION	RATINGS	UNIT
Supply voltage	V _{CC}	T _A = +25 °C	6	V
Total circuit current	I _{CC}	T _A = +25 °C	60	mA
Power dissipation	P _D	Mounted on 50 × 50 × 1.6 mm epoxy glass PWB (T _A = +85 °C)	200	mW
Operating ambient temperature	T _A		-40 to +85	°C
Storage temperature	T _{STG}		-55 to +150	°C

RECOMMENDED OPERATING CONDITIONS

PARAMETER	SYMBOL	MIN.	TYP.	MAX.	UNIT	NOTICE
Supply Voltage	V _{CC}	4.5	5.0	5.5	V	The same voltage should be applied to pin 4 and 6 pin.
Operating Ambient Temperature	T _A	-40	+25	+85	°C	

ELECTRICAL CHARACTERISTICS (T_A = +25 °C, V_{CC} = V_{out} = 5.0 V, Z_S = Z_L = 50 Ω)

PARAMETER	SYMBOL	TEST CONDITION	MIN.	TYP.	MAX.	UNIT
Circuit current	I _{CC}	No signals	18	25	33	mA
Power gain	G _P	f = 1 GHz	21	23	26	dB
Output 1 dB compression level	P _{O(1dB)}	f = 1 GHz	+4.0	+6.5	-	dBm
Noise figure	NF	f = 1 GHz	-	6.0	7.5	dB
Upper limit operating frequency	f _u	3 dB down below from gain at f = 100 MHz	2.3	2.7	-	GHz
Isolation	ISL	f = 1 GHz	27	32	-	dB
Input return loss	RL _{in}	f = 1 GHz	4.5	7.5	-	dB
Output return loss	RL _{out}	f = 1 GHz	15	20	-	dB

STANDARD CHARACTERISTICS FOR REFERENCE (T_A = +25 °C, V_{CC} = V_{out} = 5.0 V, Z_L = Z_S = 50 Ω)

PARAMETER	SYMBOL	TEST CONDITION	REFERENCE	UNIT
Gain flatness	ΔG _P	f = 0.1 to 2.0 GHz	±1	dB
Saturated output power	P _{O(sat)}	f = 1 GHz	+8.5	dBm
3rd order intermodulation distortion	IM ₃	P _{O(each)} = + 0 dBm, f ₁ = 1000 MHz, f ₂ = 1002 MHz	-30	dBc

TEST CIRCUIT

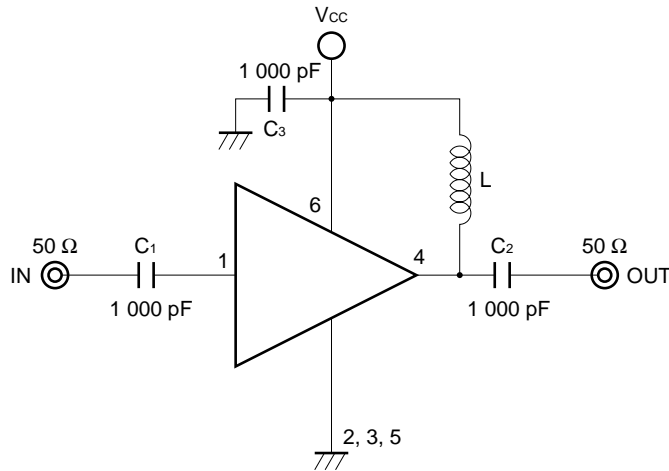

Components of test circuit for measuring electrical characteristics

	TYPE	VALUE
C ₃	Capacitor	1 000 pF
L	Bias Tee	1 000 nH
C ₁ to C ₂	Bias Tee	1 000 pF

Example of actual application components

	TYPE	VALUE	OPERATING FREQUENCY
C ₁ to C ₃	Chip capacitor	1 000 pF	100 MHz or higher
L	Chip inductor	100 nH	100 MHz or higher
		10 nH	1.0 GHz or higher

INDUCTOR FOR THE OUTPUT PIN

The internal output transistor of this IC consumes 20 mA, to output medium power. To supply current for output transistor, connect an inductor between the Vcc pin (pin 6) and output pin (pin 4). Select large value inductance, as listed above.

The inductor has both DC and AC effects. In terms of DC, the inductor biases the output transistor with minimum voltage drop to output enable high level. In terms of AC, the inductor make output-port impedance higher to get enough gain. In this case, large inductance and Q is suitable.

CAPACITORS FOR THE Vcc, INPUT, AND OUTPUT PINS

Capacitors of 1 000 pF are recommendable as the bypass capacitor for the Vcc pin and the coupling capacitors for the input and output pins.

The bypass capacitor connected to the Vcc pin is used to minimize ground impedance of Vcc pin. So, stable bias can be supplied against Vcc fluctuation.

The coupling capacitors, connected to the input and output pins, are used to cut the DC and minimize RF serial impedance. Their capacitance are therefore selected as lower impedance against a 50 Ω load. The capacitors thus perform as high pass filters, suppressing low frequencies to DC.

To obtain a flat gain from 100 MHz upwards, 1 000 pF capacitors are used in the test circuit. In the case of under 10 MHz operation, increase the value of coupling capacitor such as 10 000 pF. Because the coupling capacitors are determined by equation, $C = 1/(2\pi Rfc)$.

Illustration of the application circuit assembled on evaluation board

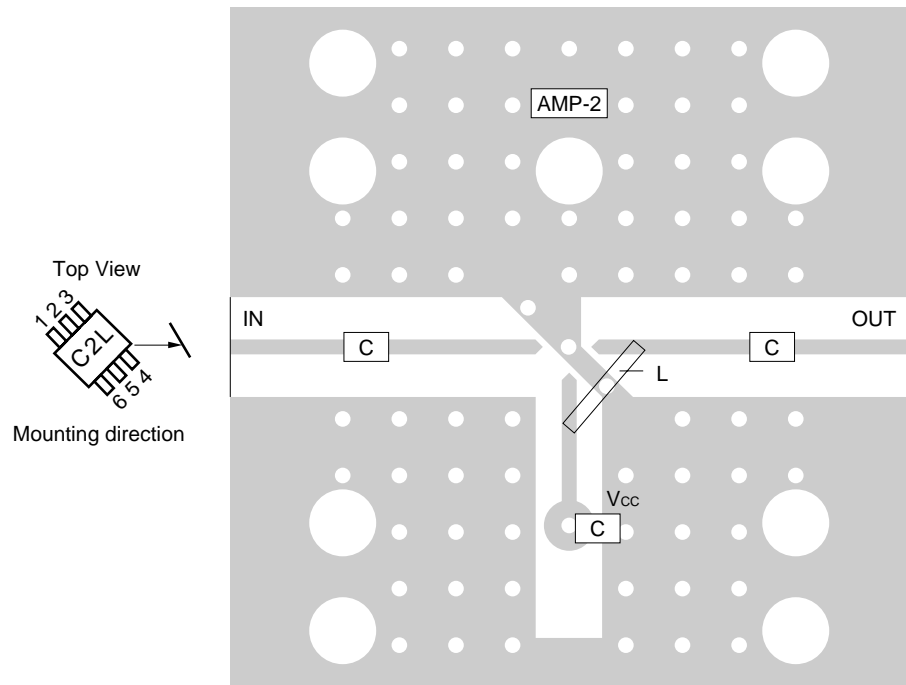

Component List

	Value
C	1 000 pF
L	100 nH, etc

Notes

1. 30 × 30 × 0.4 mm double sided copper clad polyimide board.
2. Back side: GND pattern
3. Solder plated on pattern
4. ⊕ ⊕ ⊕ : Through holes

TYPICAL CHARACTERISTICS (Unless otherwise specified, $T_A = +25\text{ }^\circ\text{C}$)

CIRCUIT CURRENT vs. SUPPLY VOLTAGE

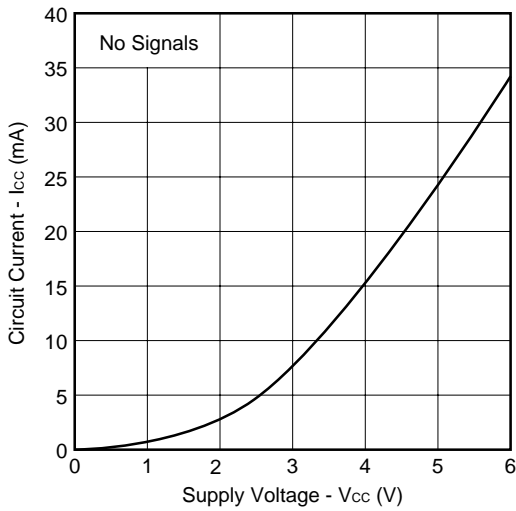

CIRCUIT CURRENT vs. OPERATING TEMPERATURE

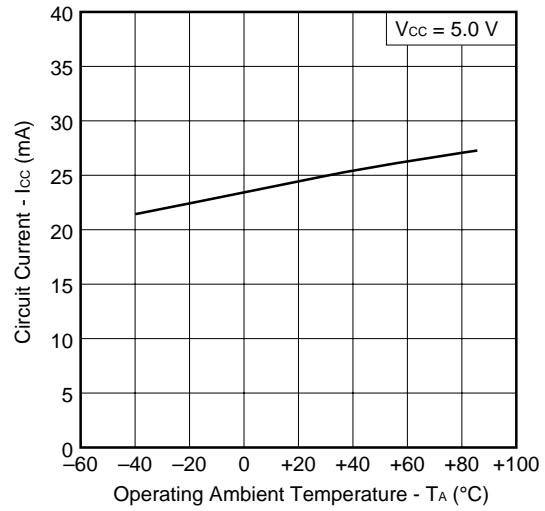

NOISE FIGURE, POWER GAIN vs. FREQUENCY

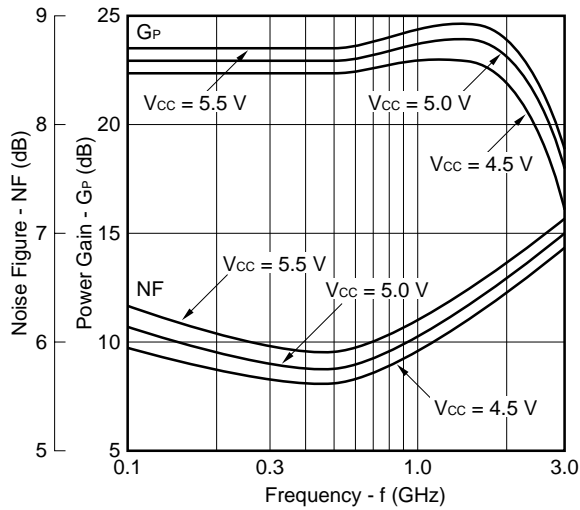

POWER GAIN vs. FREQUENCY

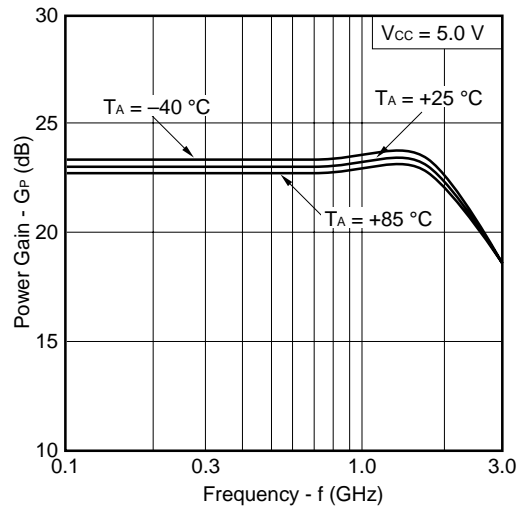

ISOLATION vs. FREQUENCY

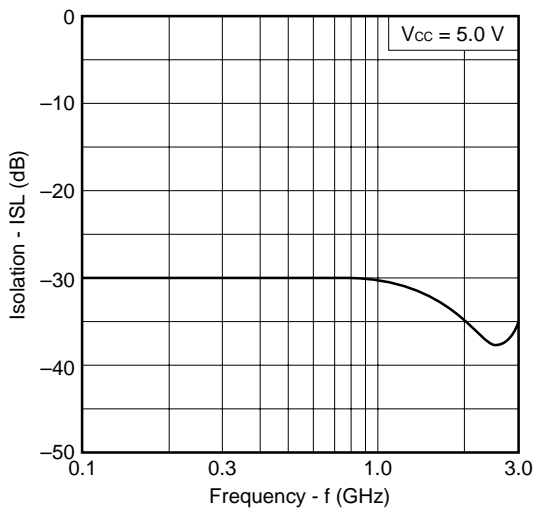

INPUT RETURN LOSS, OUTPUT RETURN LOSS vs. FREQUENCY

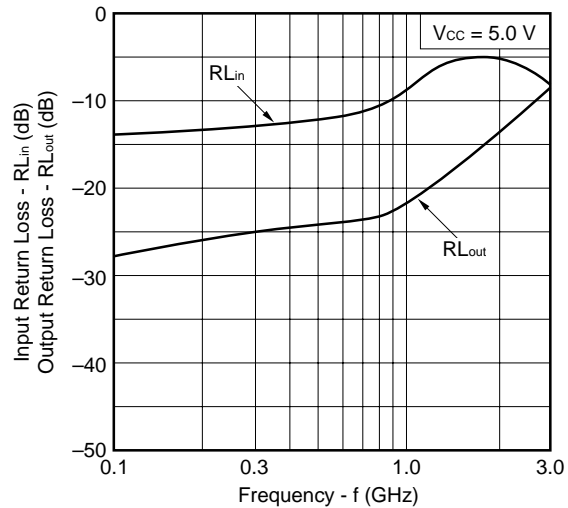

OUTPUT POWER vs. INPUT POWER

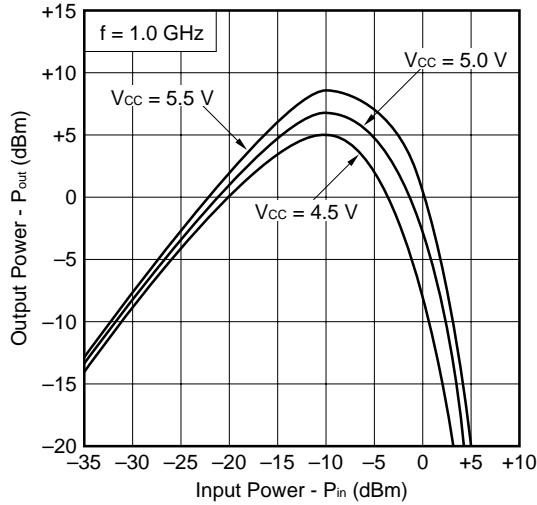

OUTPUT POWER vs. INPUT POWER

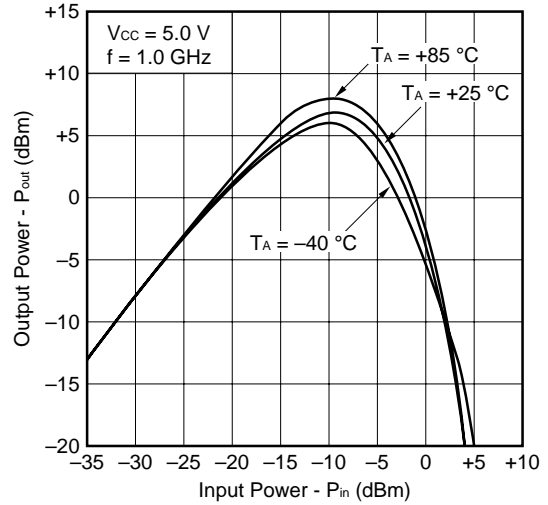

OUTPUT POWER vs. INPUT POWER

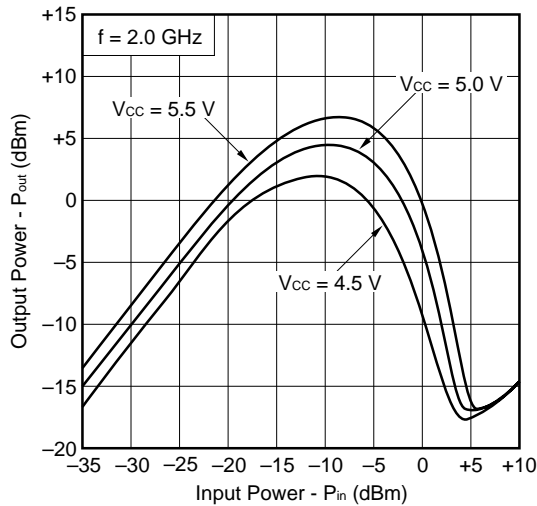

OUTPUT POWER vs. INPUT POWER

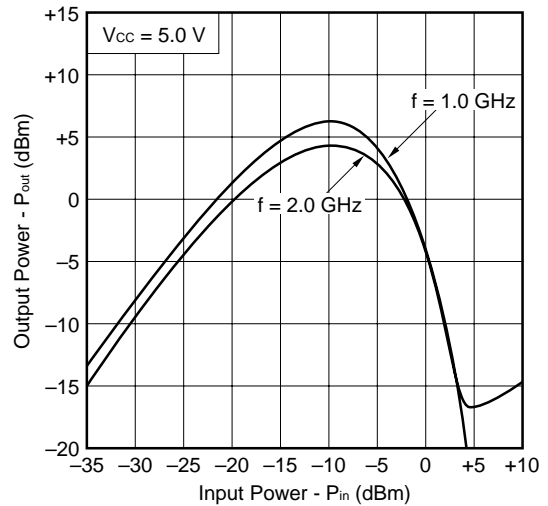

SATURATED OUTPUT POWER vs. FREQUENCY

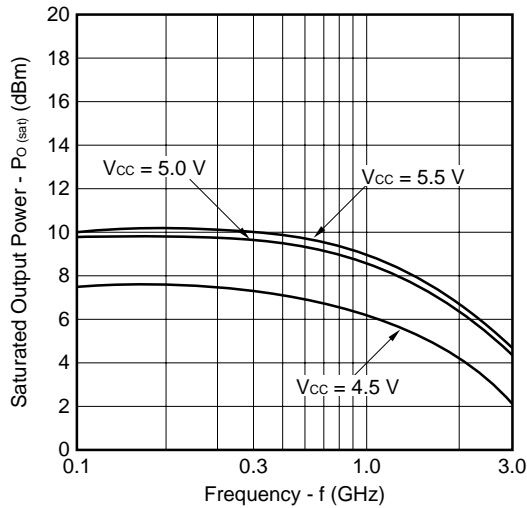

3RD ORDER INTERMODULATION DISTORTION vs. OUTPUT POWER OF EACH TONE

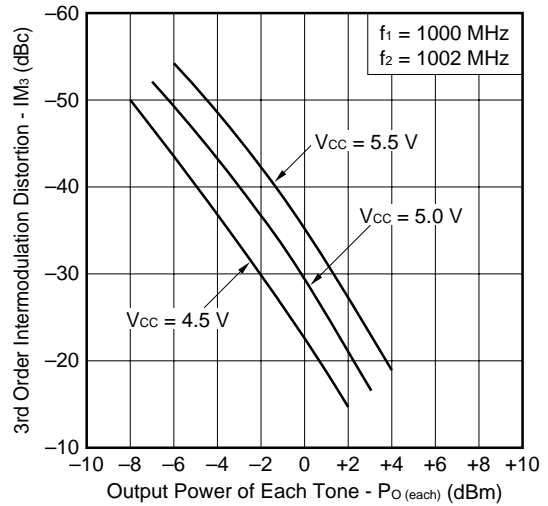

S-Parameter ($V_{CC} = V_{out} = 5.0\text{ V}$)

S₁₁- FREQUENCY

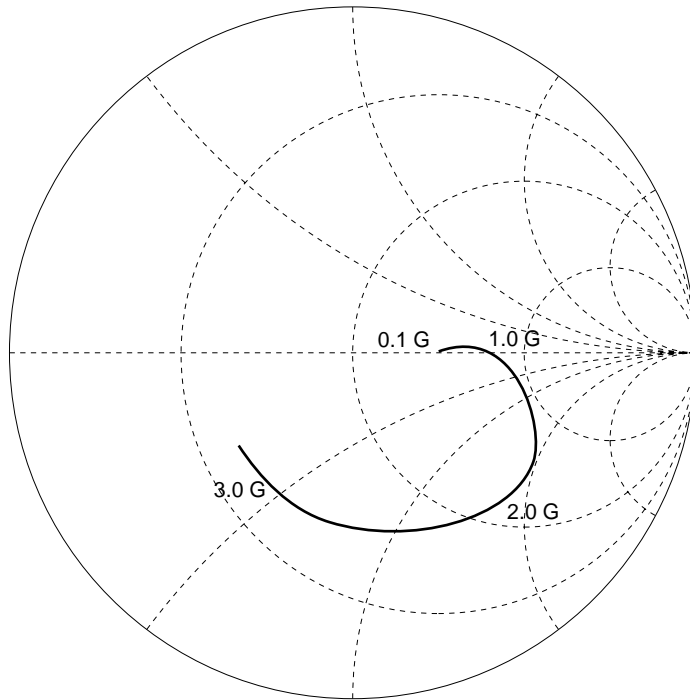

S₂₂- FREQUENCY

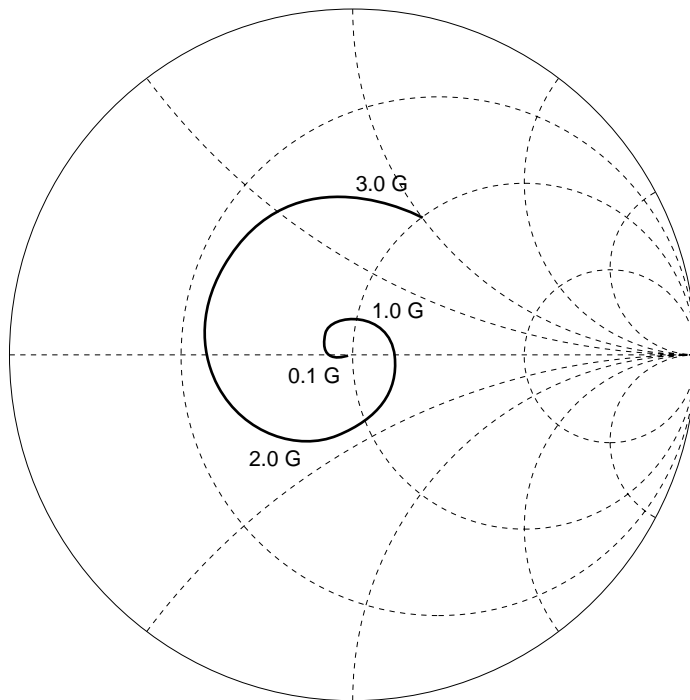

Typical S-Parameter Values (TA = +25 °C)

μPC2776TB

VCC = Vout = 5.0 V, Icc = 27 mA

FREQUENCY MHz	S11		S21		S12		S22		K
	MAG	ANG	MAG	ANG	MAG	ANG	MAG	ANG	
100.0000	.226	2.8	13.844	-5.9	.029	-1.5	.032	-177.4	1.39
200.0000	.240	6.4	13.862	-12.5	.029	0.3	.024	-171.9	1.39
300.0000	.254	10.4	13.942	-18.6	.028	3.2	.030	-176.3	1.40
400.0000	.267	11.4	14.123	-25.2	.029	4.8	.031	-167.6	1.36
500.0000	.285	11.1	14.267	-31.8	.029	7.2	.037	-167.3	1.33
600.0000	.308	8.5	14.423	-38.6	.029	9.3	.038	-159.3	1.28
700.0000	.345	6.1	14.670	-45.5	.030	10.7	.040	-160.7	1.22
800.0000	.386	3.9	14.864	-52.8	.030	11.0	.043	-161.9	1.18
900.0000	.425	1.4	15.210	-60.1	.031	11.9	.055	-169.0	1.12
1000.0000	.449	-1.5	15.455	-68.4	.030	11.8	.072	-169.1	1.10
1100.0000	.466	-6.1	15.564	-76.6	.030	10.6	.084	-169.1	1.08
1200.0000	.478	-12.0	15.550	-84.9	.030	11.7	.093	-173.6	1.07
1300.0000	.507	-17.7	15.622	-93.1	.030	13.4	.094	177.9	1.05
1400.0000	.533	-24.7	15.577	-101.3	.029	13.2	.114	167.0	1.05
1500.0000	.564	-30.3	15.527	-110.6	.029	13.5	.130	164.1	1.02
1600.0000	.568	-36.4	15.285	-119.0	.027	11.3	.154	158.0	1.07
1700.0000	.576	-42.0	14.960	-127.8	.026	12.6	.167	152.6	1.09
1800.0000	.571	-48.5	14.570	-136.4	.024	14.8	.179	143.0	1.18
1900.0000	.570	-54.5	14.026	-144.7	.023	15.8	.194	135.2	1.27
2000.0000	.569	-59.7	13.715	-151.7	.022	18.2	.212	128.1	1.35
2100.0000	.564	-64.2	13.283	-159.8	.020	23.5	.228	121.6	1.48
2200.0000	.548	-69.6	12.926	-167.5	.018	27.1	.240	115.9	1.66
2300.0000	.535	-75.5	12.515	-174.8	.018	36.3	.251	108.1	1.75
2400.0000	.516	-81.8	12.093	177.9	.016	41.9	.268	102.4	2.01
2500.0000	.515	-87.0	11.498	170.1	.017	53.3	.279	96.0	1.99
2600.0000	.508	-90.9	11.136	163.1	.015	64.3	.296	90.8	2.22
2700.0000	.503	-94.8	10.511	156.6	.015	67.9	.306	86.7	2.29
2800.0000	.489	-97.6	10.126	148.3	.018	85.0	.315	79.2	2.00
2900.0000	.471	-101.3	9.850	143.2	.019	93.7	.330	73.0	1.96
3000.0000	.457	-106.7	9.242	135.5	.022	100.0	.343	67.0	1.81
3100.0000	.455	-111.3	9.065	128.9	.026	108.0	.357	60.7	1.53

PACKAGE DIMENSIONS

6 pin super minimold (unit: mm)

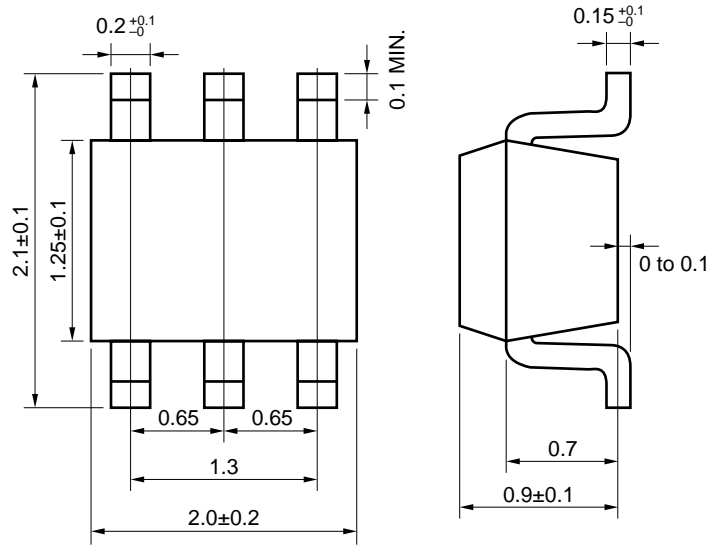

NOTE ON CORRECT USE

- (1) Observe precautions for handling because of electro-static sensitive devices.
- (2) Form a ground pattern as wide as possible to minimize ground impedance (to prevent undesired oscillation).
All the ground pins must be connected together with wide ground pattern to decrease impedance difference.
- (3) The bypass capacitor (e.g. 1 000 pF) should be attached to Vcc pin.
- (4) The inductor must be attached between Vcc and output pin (e.g. 100 nH)
- (5) The DC cut capacitor must be each attached to the input and output pins.

RECOMMENDED SOLDERING CONDITIONS

This product should be soldered in the following recommended conditions. Other soldering methods and conditions than the recommended conditions are to be consulted with our sales representatives.

μPC2776TB

Soldering method	Soldering conditions	Recommended condition symbol
Infrared ray reflow	Package peak temperature: 235 °C, Hour: within 30 s. (more than 210 °C), Time: 3 times, Limited days: no. ^{Note}	IR35-00-3
VPS	Package peak temperature: 215 °C, Hour: within 40 s. (more than 200 °C), Time: 3 times, Limited days: no. ^{Note}	VP15-00-3
Wave soldering	Soldering tub temperature: less than 260 °C, Hour: within 10 s. Time: 1 time, Limited days: no. ^{Note}	WS60-00-1
Pin part heating	Pin area temperature: less than 300 °C, Hour: within 3 s/pin. Limited days: no. ^{Note}	

Note It is the storage days after opening a dry pack, the storage conditions are 25 °C, less than 65 % RH.

Caution The combined use of soldering method is to be avoided (However, except the pin area heating method).

For details of recommended soldering conditions for surface mounting, refer to information document **SEMICONDUCTOR DEVICE MOUNTING TECHNOLOGY MANUAL (C10535E)**.



ATTENTION

OBSERVE PRECAUTIONS
FOR HANDLING
ELECTROSTATIC
SENSITIVE
DEVICES

The application circuits and their parameters are for reference only and are not intended for use in actual design-ins.

No part of this document may be copied or reproduced in any form or by any means without the prior written consent of NEC Corporation. NEC Corporation assumes no responsibility for any errors which may appear in this document.

NEC Corporation does not assume any liability for infringement of patents, copyrights or other intellectual property rights of third parties by or arising from use of a device described herein or any other liability arising from use of such device. No license, either express, implied or otherwise, is granted under any patents, copyrights or other intellectual property rights of NEC Corporation or others.

While NEC Corporation has been making continuous effort to enhance the reliability of its semiconductor devices, the possibility of defects cannot be eliminated entirely. To minimize risks of damage or injury to persons or property arising from a defect in an NEC semiconductor device, customers must incorporate sufficient safety measures in its design, such as redundancy, fire-containment, and anti-failure features.

NEC devices are classified into the following three quality grades:

"Standard", "Special", and "Specific". The Specific quality grade applies only to devices developed based on a customer designated "quality assurance program" for a specific application. The recommended applications of a device depend on its quality grade, as indicated below. Customers must check the quality grade of each device before using it in a particular application.

Standard: Computers, office equipment, communications equipment, test and measurement equipment, audio and visual equipment, home electronic appliances, machine tools, personal electronic equipment and industrial robots

Special: Transportation equipment (automobiles, trains, ships, etc.), traffic control systems, anti-disaster systems, anti-crime systems, safety equipment and medical equipment (not specifically designed for life support)

Specific: Aircrafts, aerospace equipment, submersible repeaters, nuclear reactor control systems, life support systems or medical equipment for life support, etc.

The quality grade of NEC devices is "Standard" unless otherwise specified in NEC's Data Sheets or Data Books. If customers intend to use NEC devices for applications other than those specified for Standard quality grade, they should contact an NEC sales representative in advance.

Anti-radioactive design is not implemented in this product.

M4 96.5

NESAT (NEC Silicon Advanced Technology) is a trademark of NEC Corporation.