

BIPOLAR ANALOG INTEGRATED CIRCUIT

μ PC8112TB

SILICON MMIC 1st FREQUENCY DOWN-CONVERTER FOR CELLULAR/CORDLESS TELEPHONE

DESCRIPTION

The μ PC8112TB is a silicon monolithic integrated circuit designed as 1st frequency down-converter for cellular/cordless telephone receiver stage. This IC consists of mixer and local amplifier. The μ PC8112TB features high impedance output of open collector. Similar ICs of the μ PC2757TB and μ PC2758TB feature low impedance output of emitter follower. These TB suffix ICs which are smaller package than conventional T suffix ICs contribute to reduce your system size.

The μ PC8112TB is manufactured using NEC's 20 GHz f_T NESAT™III silicon bipolar process. This process uses silicon nitride passivation film and gold electrodes. These materials can protect chip surface from external pollution and prevent corrosion/migration. Thus, this IC has excellent performance, uniformity and reliability.

FEATURES

- Excellent RF performance : IIP₃ = -7 dBm@f_{RFIn} = 1.9 GHz (reference)
IM₃ = -88 dBc@P_{RFIn} = -38 dBm, 1.9 GHz (reference)
- Similar conversion gain to μ PC2757 and lower noise figure than μ PC2758
- Minimized carrier leakage : RF_{lo} = -80 dB@f_{RFIn} = 900 MHz (reference)
RF_{lo} = -55 dB@f_{RFIn} = 1.9 GHz (reference)
- High linearity : P_{O(sat)} = -2.5 dBm TYP.@f_{RFIn} = 900 MHz
P_{O(sat)} = -3 dBm TYP.@f_{RFIn} = 1.9 GHz
- Low current consumption : I_{CC} = 8.5 mA TYP.
- Supply voltage : V_{CC} = 2.7 to 3.3 V
- High-density surface mounting : 6-pin super minimold package

APPLICATIONS

- 1.5 GHz to 1.9 GHz cellular/cordless telephone (PHS, DECT, PDC1.5G and so on)
- 800 MHz to 900 MHz cellular telephone (PDC800M and so on)

ORDER INFORMATION

Part Number	Package	Markings	Supplying Form
μ PC8112TB-E3	6-pin super minimold	C2K	Embossed tape 8 mm wide. Pin 1, 2, 3 face the tape perforation side. Qty 3kpcs/reel.

Remark To order evaluation samples, please contact your local NEC sales office.
(Part number for sample order: μ PC8112TB)

Caution Electro-static sensitive devices

The information in this document is subject to change without notice. Before using this document, please confirm that this is the latest version.
Not all devices/types available in every country. Please check with local NEC representative for availability and additional information.

PIN CONNECTIONS

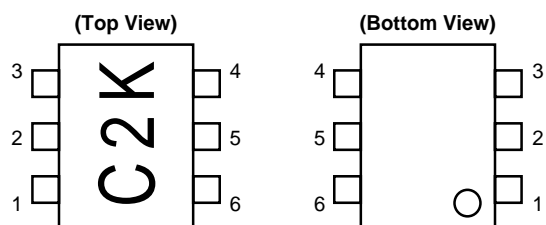

Pin No.	Pin Name
1	RFinpu
2	GND
3	LOinput
4	PS
5	Vcc
6	IFoutput

PRODUCT LIN-UP (T_A = +25°C, V_{CC} = 3.0 V, Z_s = Z_L = 50 Ω)

Part Number	Items	No RF I _{cc} (mA)	900 MHz SSB · NF (dB)	1.5 GHz SSB · NF (dB)	1.9 GHz SSB · NF (dB)	900 MHz CG (dB)	1.5 GHz CG (dB)	1.9 GHz CG (dB)	900 MHz IIP ₃ (dBm)	1.5 GHz IIP ₃ (dBm)	1.9 GHz IIP ₃ (dBm)
μPC2757T		5.6	10	10	13	15	15	13	-14	-14	-12
μPC2757TB											
μPC2758T		11	9	10	13	19	18	17	-13	-12	-11
μPC2758TB											
μPC8112T		8.5	9	11	11	15	13	13	-10	-9	-7
μPC8112TB											

Part Number	Items	900 MHz P _{O(sat)} (dBm)	1.5 GHz P _{O(sat)} (dBm)	1.9 GHz P _{O(sat)} (dBm)	900 MHz RF _{Lo} (dB)	1.5 GHz RF _{Lo} (dB)	1.9 GHz RF _{Lo} (dB)	IF Output Configuration	Package
μPC2757T		-3	-	-8	-	-	-	Emitter follower	6-pin minimold
μPC2757TB									6-pin super minimold
μPC2758T	+1	-	-4	-	-	-	6-pin minimold		
μPC2758TB							6-pin super minimold		
μPC8112T		-2.5	-3	-3	-80	-57	-55	Open collector	6-pin minimold
μPC8112TB									6-pin super minimold

Remark Typical performance. Please refer to ELECTRICAL CHARACTERISTICS in detail.

- Caution**
1. The μPC2757 and μPC2758's IIP₃ are calculated with ΔIM₃ = 3 which is the same IM₃ inclination as μPC8112. On the other hand, OIP₃ of Standard characteristics in page 6 is cross point IP.
 2. This document is to be specified for μPC8112TB. The other part number mentioned in this document should be referred to the data sheet of each part number.

INTERNAL BLOCK DIAGRAM

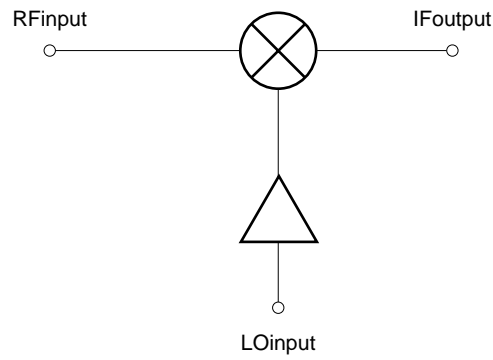

μ PC8112TB LOCATION EXAMPLE IN THE SYSTEM

Digital cordless phone

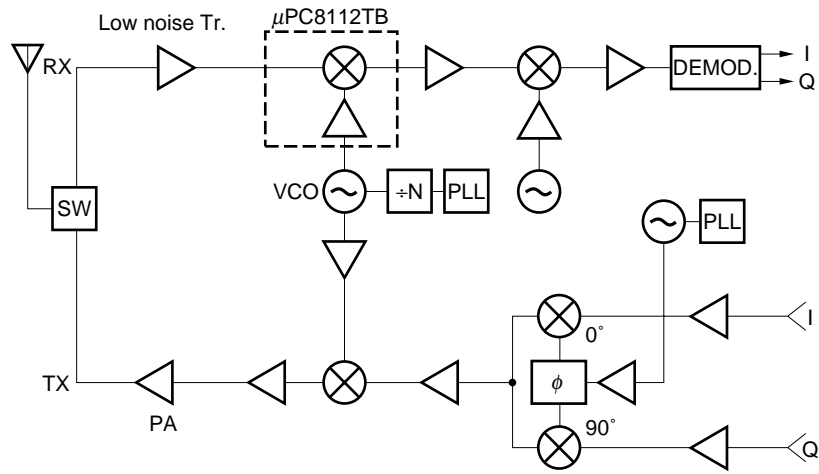

PIN EXPLANATION

Pin No.	Pin Name	Applied Voltage (V)	Pin Voltage (V)	Function and Application	Internal Equivalent Circuit								
1	RFinput	–	1.2	RF input pin of mixer. This mixer is designed as double balanced type. This pin should be externally coupled to front stage with DC cut capacitor.									
2	GND	0	–	Ground pin. This pin must be connected to the system ground. Form the ground pattern as wide as possible and the track length as short as possible to minimize ground impedance.									
5	Vcc	2.7 to 3.3	–	Supply voltage pin. This pin should be connected with bypass capacitor (example: 1 000 pF) to minimize ground impedance.									
6	IFoutput	as same as Vcc voltage through external inductor	–	IF output pin. This output is configured with open collector of high impedance. This pin should be externally equipped with matching circuit of inductor should be selected as small resistance and high frequency use.									
3	LOinput	–	1.4	Input pin of local amplifier. This amplifier is designed as differential type. This pin should be externally coupled to local signal source with DC cut capacitor. Recommendable input level is –15 to 0 dBm.									
4	PS	Vcc or GND	–	Power save control pin. This pin can control ON/OFF operation with bias as follows; <table border="1" style="margin: 10px auto;"> <thead> <tr> <th></th> <th>Bias: V</th> <th>Operation</th> </tr> </thead> <tbody> <tr> <td rowspan="2">V_{Ps}</td> <td>≥ 2.5</td> <td>ON</td> </tr> <tr> <td>0 to 0.5</td> <td>OFF</td> </tr> </tbody> </table>		Bias: V	Operation	V _{Ps}	≥ 2.5	ON	0 to 0.5	OFF	
	Bias: V	Operation											
V _{Ps}	≥ 2.5	ON											
	0 to 0.5	OFF											

ABSOLUTE MAXIMUM RATINGS

Parameter	Symbol	Conditions	Ratings	Unit
Supply Voltage	V _{CC}	T _A = +25°C, 5 pin and 6 pin	3.6	V
Total Circuit Current	I _{CC}	T _A = +25°C	77.7	mA
Total Power Dissipation	P _D	Mounted on double sided copper clad 50 × 50 × 1.6 mm epoxy glass PWB (T _A = +85°C)	200	mW
Operating Ambient Temperature	T _A		-40 to +85	°C
Storage Temperature	T _{stg}		-55 to +150	°C

RECOMMENDED OPERATING CONDITIONS

Parameter	Symbol	MIN.	TYP.	MAX.	Unit	Remark
Supply Voltage	V _{CC}	2.7	3.0	3.3	V	5 pin and 6 pin should be applied to same voltage.
Operating Ambient Temperature	T _A	-40	+25	+85	°C	
LO Input Level	P _{LOin}	-15	-10	0	dBm	Z _s = 50 Ω
RF Input Frequency	f _{RFIn}	0.8	1.9	2.0	GHz	
IF Output Frequency	f _{IFout}	100	250	300	MHz	With external matching

ELECTRICAL CHARACTERISTICS (Unless otherwise specified, T_A = +25°C, V_{CC} = V_{PS} = V_{IFout} = 3.0 V, P_{LOin} = -10 dBm, Z_s = Z_L = 50 Ω)

Parameter	Symbol	Test Conditions	MIN.	TYP.	MAX.	Unit
Circuit Current	I _{CC}	No signals	4.9	8.5	11.7	mA
Circuit Current at Power Save Mode	I _{CC(PS)}	V _{CC} = 3.0 V, V _{PS} = 0.5 V	-	-	0.1	μA
Conversion Gain	CG	f _{RFIn} = 900 MHz, f _{LOin} = 1 000 MHz f _{RFIn} = 1.9 GHz, f _{LOin} = 1.66 GHz	11.5 9.5	15 13	17.5 15.5	dB
Single Side Band Noise Figure	SSB-NF	f _{RFIn} = 900 MHz, f _{LOin} = 1 000 MHz f _{RFIn} = 1.9 GHz, f _{LOin} = 1.66 GHz	- -	9.0 11.2	11 13.2	dB
Saturated Output Power	P _{O(sat)}	f _{RFIn} = 900 MHz, f _{LOin} = 1 000 MHz f _{RFIn} = 1.9 GHz, f _{LOin} = 1.66 GHz (P _{RFIn} = -10 dBm each)	-6.5 -7	-2.5 -3	- -	dBm

STANDARD CHARACTERISTICS FOR REFERENCE

($T_A = +25^{\circ}\text{C}$, $V_{CC} = V_{PS} = V_{IFout} = 3.0\text{ V}$, $P_{LOin} = -10\text{ dBm}$, $Z_s = Z_L = 50\ \Omega$)

Parameter	Symbol	Test Conditions	Reference	Unit
Conversion Gain	CG	$f_{RFin} = 1.5\text{ GHz}$, $f_{LOin} = 1.6\text{ GHz}$	13	dB
Single Side Band Noise Figure	SSB·NF	$f_{RFin} = 1.5\text{ GHz}$, $f_{LOin} = 1.6\text{ GHz}$	11	dB
LO Leakage at RF pin	LO _{RF}	$f_{RFin} = 900\text{ MHz}$, $f_{LOin} = 1\ 000\text{ MHz}$ $f_{RFin} = 1.5\text{ GHz}$, $f_{LOin} = 1.6\text{ GHz}$ $f_{RFin} = 1.9\text{ GHz}$, $f_{LOin} = 1.66\text{ GHz}$	-45 -46 -45	dB
RF Leakage at LO pin	RF _{LO}	$f_{RFin} = 900\text{ MHz}$, $f_{LOin} = 1\ 000\text{ MHz}$ $f_{RFin} = 1.5\text{ GHz}$, $f_{LOin} = 1.6\text{ GHz}$ $f_{RFin} = 1.9\text{ GHz}$, $f_{LOin} = 1.66\text{ GHz}$	-80 -57 -55	dB
LO Leakage at IF pin	LO _{if}	$f_{RFin} = 900\text{ MHz}$, $f_{LOin} = 1\ 000\text{ MHz}$ $f_{RFin} = 1.5\text{ GHz}$, $f_{LOin} = 1.6\text{ GHz}$ $f_{RFin} = 1.9\text{ GHz}$, $f_{LOin} = 1.66\text{ GHz}$	-32 -33 -30	dB
Input 3rd Order Intercept Point ^{Note}	IIP ₃	$f_{RFin} = 900\text{ MHz}$, $f_{LOin} = 1\ 000\text{ MHz}$ $f_{RFin} = 1.5\text{ GHz}$, $f_{LOin} = 1.6\text{ GHz}$ $f_{RFin} = 1.9\text{ GHz}$, $f_{LOin} = 1.66\text{ GHz}$	-10 -9 -7	dBm

Note IIP₃ is determined by comparing two method; theoretical calculation and cross point of IM₃ curve.

$$IIP_3 = (\Delta IM_3 \times P_{in} + CG - IM_3) \div (\Delta IM_3 - 1) \text{ (dBm)} \quad [\Delta IM_3: IM_3 \text{ curve inclination in linear range}]$$

μPC8112's ΔIM₃ is closer to 3 (theoretical inclination) than μPC2757 and μPC2758 of conventional ICs.

TEST CIRCUIT

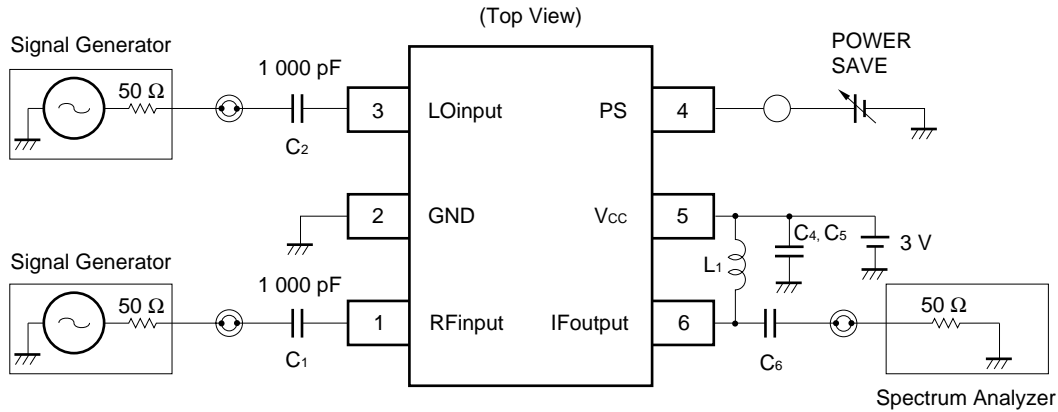
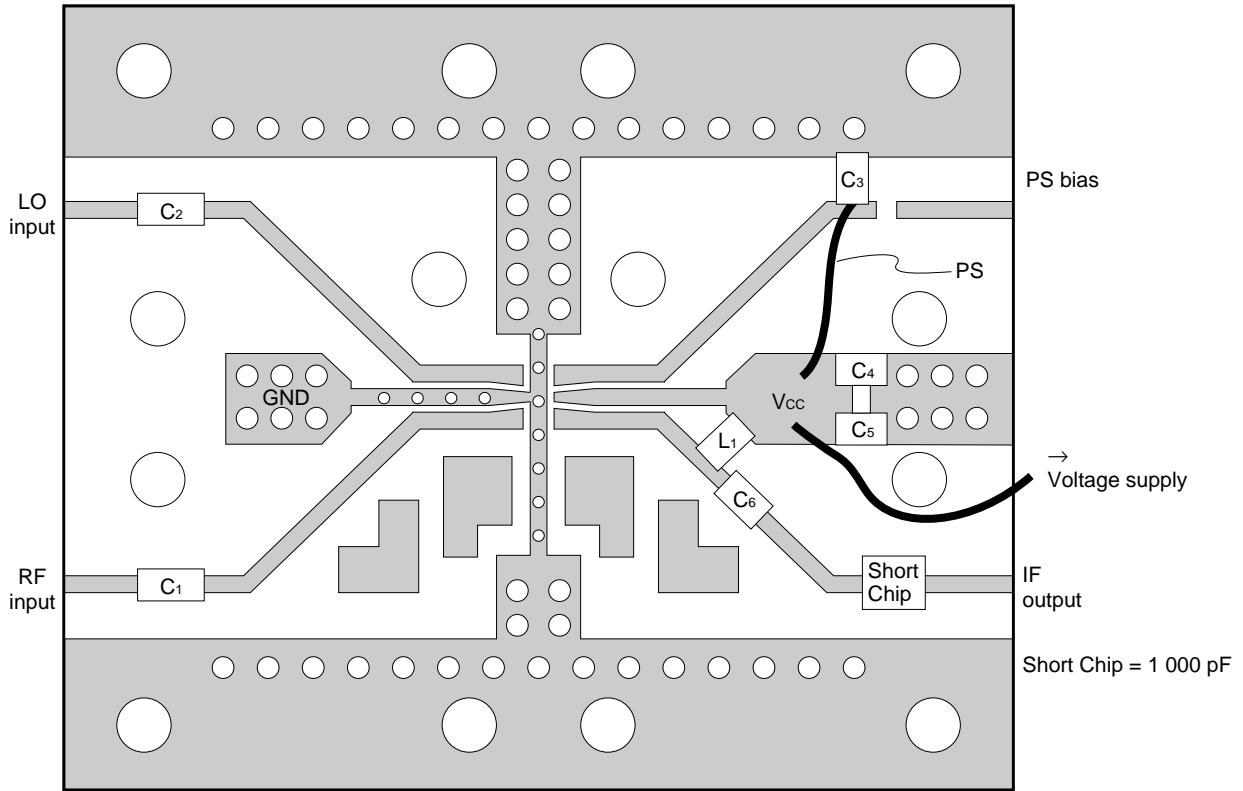

ILLUSTRATION OF THE TEST CIRCUIT ASSEMBLED ON EVALUATION BOARD



Component Number	IF 100 MHz Matching	IF 240 MHz Matching	Remarks
C1 to C5	1 000 pF	1 000 pF	CHIP C
C6	5 pF	2 pF	CHIP C
L1	330 nH	84 nH	CHIP L

EVALUATION BOARD CHARACTERS AND NOTE

- (1) 35 μm thick double-sided copper clad 35 × 42 × 0.4 mm polyimide board
- (2) Back side: GND pattern
- (3) Solder plated patterns
- (4) ○○: Through holes
- (5) To mount C6, pattern should be cut.

CAUTION Test circuit or print pattern in this sheet is for testing IC characteristics. They are not an application circuit or recommended system circuit.
 In the case of actual system application, external circuits including print pattern and matching circuit constant of output port should be designed in accordance with IC's S-parameters and environmental components.

Remark External circuits of the IC can be referred to following application notes.
 • USAGE AND APPLICATION CHARACTERISTICS OF μPC2757, μPC2758, AND μPC8112, 3-V POWER SUPPLY, 1.9-GHz FREQUENCY DOWN-CONVERTER ICS FOR MOBILE COMMUNICATION (Document No. P11997E)

★ TYPICAL CHARACTERISTICS (T_A = +25°C, unless otherwise specified, measured on test circuits)

–Without Signals–

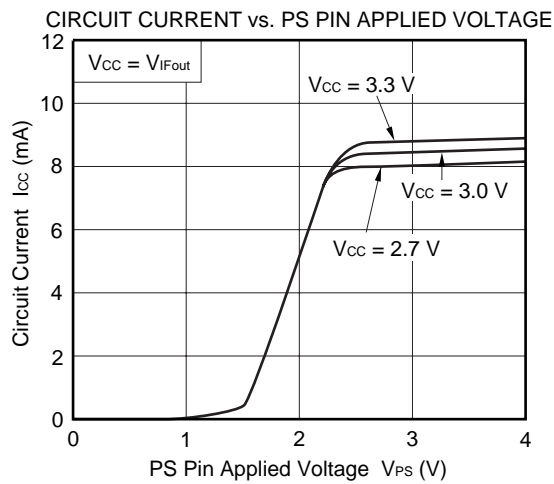
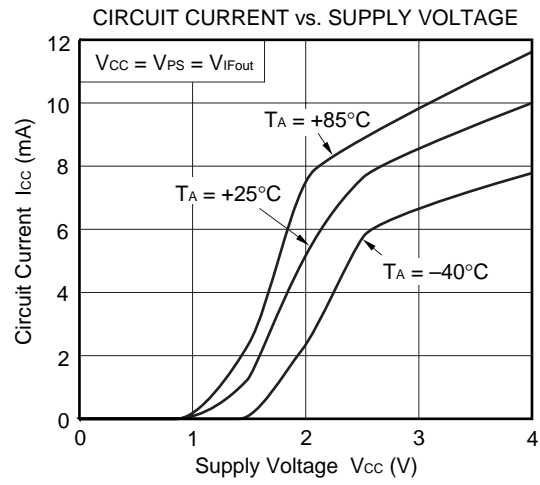
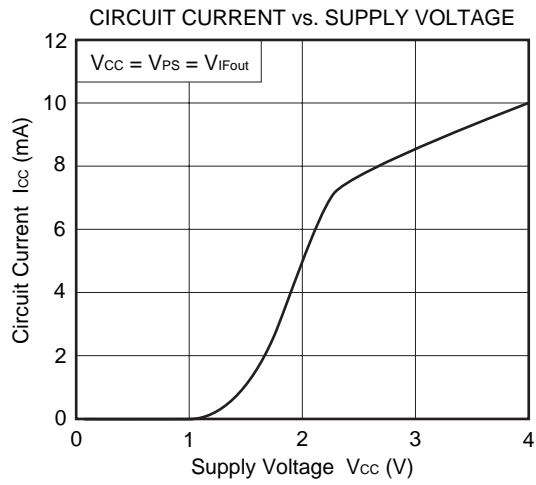

★ S-PARAMETERS

–Calibrated on pin of DUT–

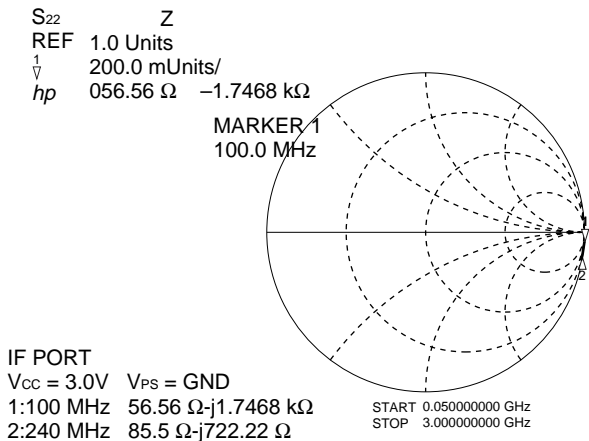
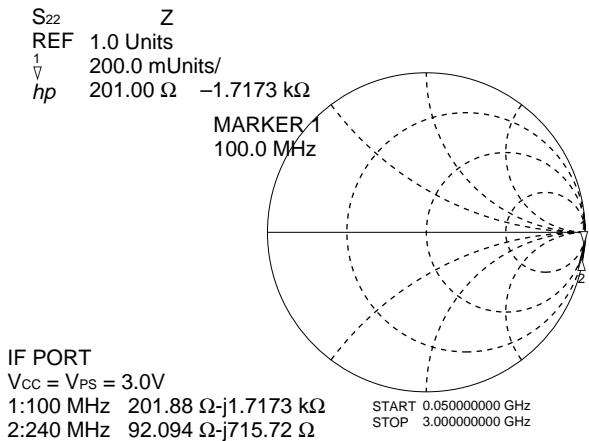
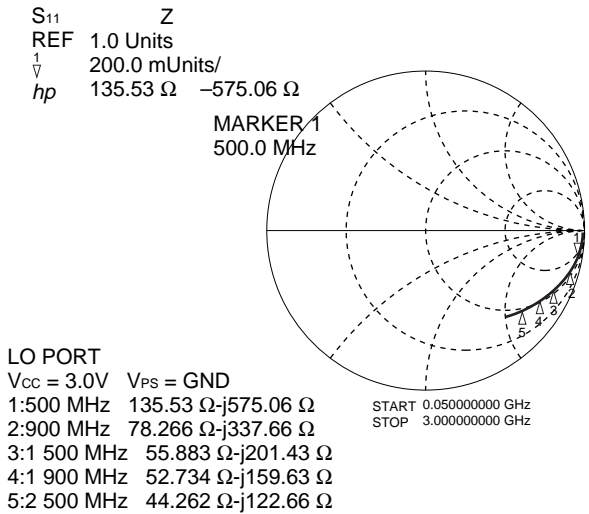
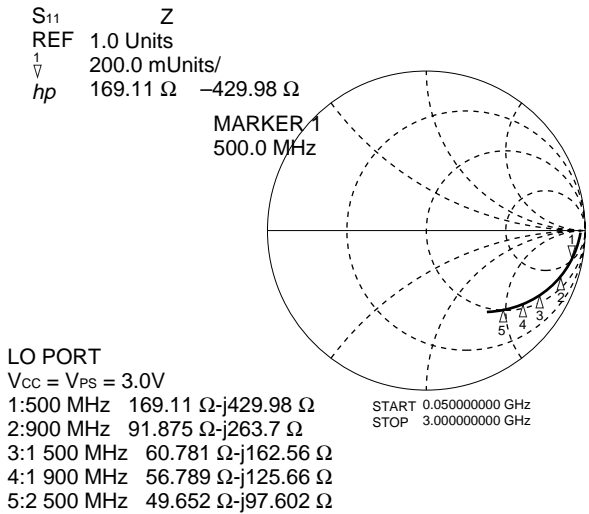
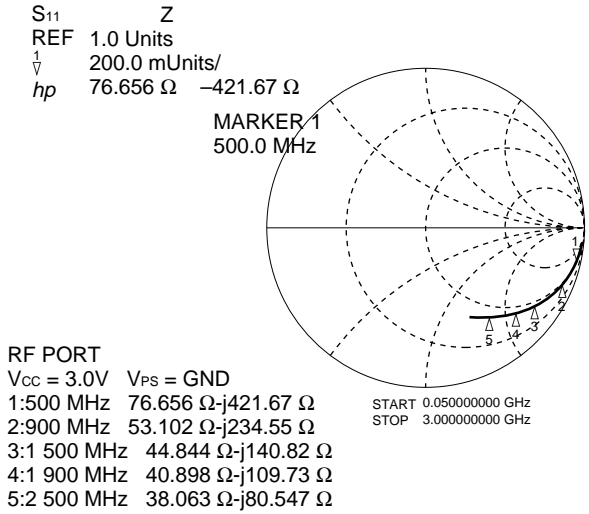
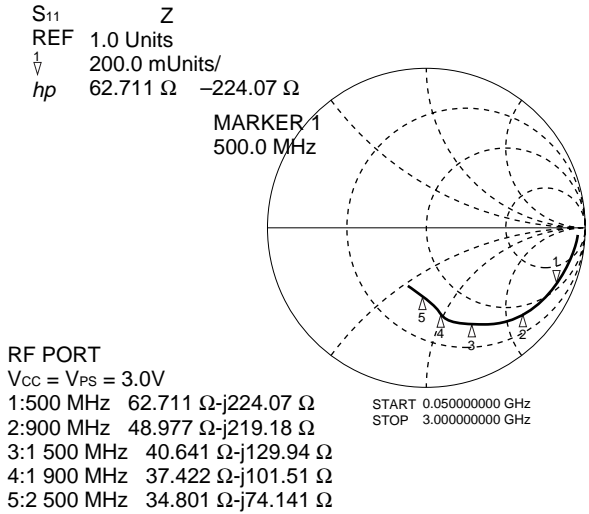

★ S-PARAMETERS OF IF OUTPUT MATCHING ($V_{CC} = V_{PS} = V_{IFout} = 3.0\text{ V}$) –ON TEST CIRCUIT–
 (This S_{11} is monitored at IF connector on test circuit fixture)

IF 100 MHz MATCHING

S_{11} 1 U FS 1: 50.277 Ω -22.559 Ω 70.552 pF
 hp 100.000 000 MHz

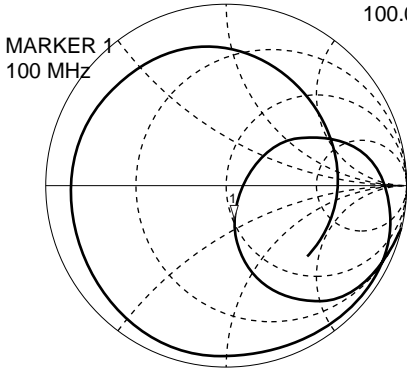

START 50.000 000 MHz STOP 3 000.000 000 MHz

IF 240 MHz MATCHING

S_{11} 1 U FS 1: 31.052 Ω -84.961 m Ω 7.8053 nF
 hp 240.000 000 MHz

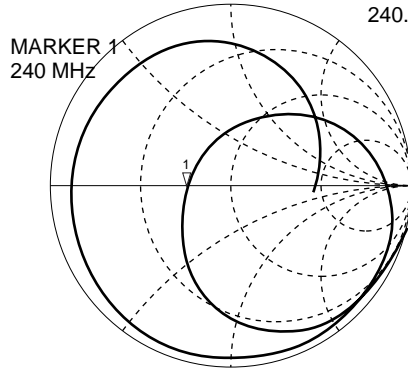

START 50.000 000 MHz STOP 3 000.000 000 MHz

S_{11} log MAG. 10 dB/ REF 0 dB 1: -27.655 dB

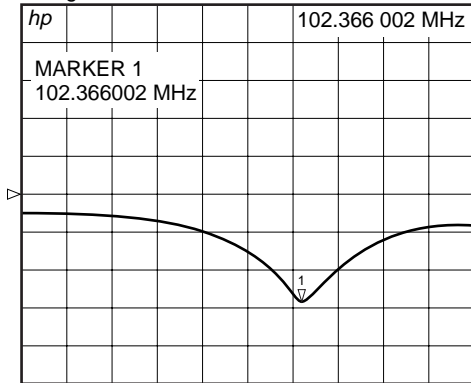

START 90.000 000 MHz STOP 110.000 000 MHz

S_{11} log MAG. 10 dB/ REF 0 dB 1: -13.556 dB

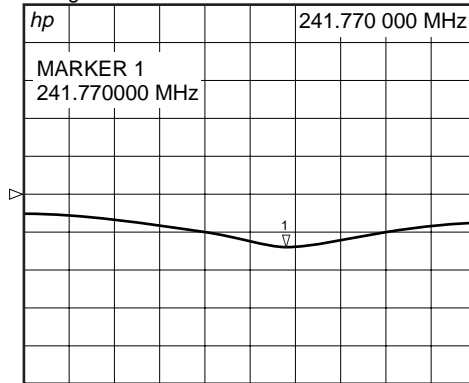

START 230.000 000 MHz STOP 250.000 000 MHz

The data in this page are to make clear the test condition of impedance matched to next stage, not specify the recommended condition. The S_{11} smith charts of the test fixture setting IC are normalized to $Z_o = 50\ \Omega$, because the IC's load is the measurement equipment of $50\ \Omega$ impedance.

In your use, the output return loss value can be helpful information to adjust your circuit matching to next stage.

★ IF 100 MHz MATCHING

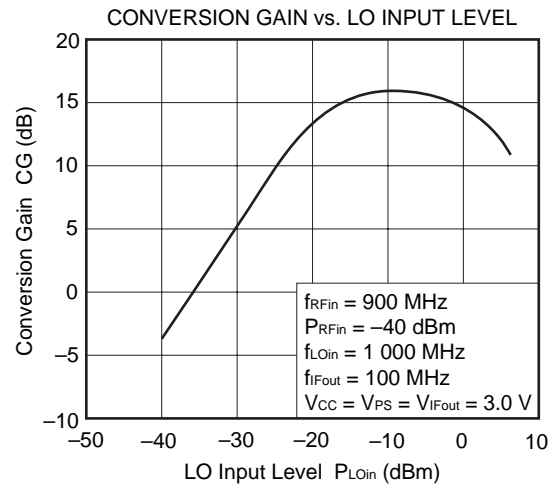
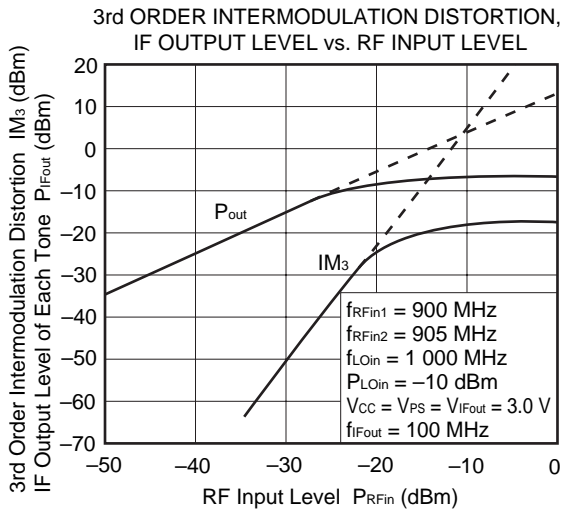
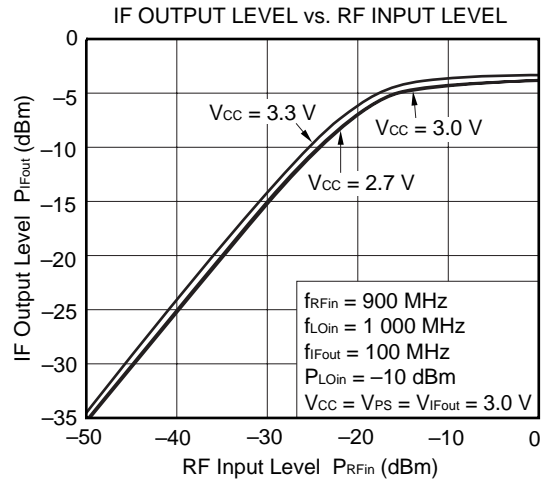
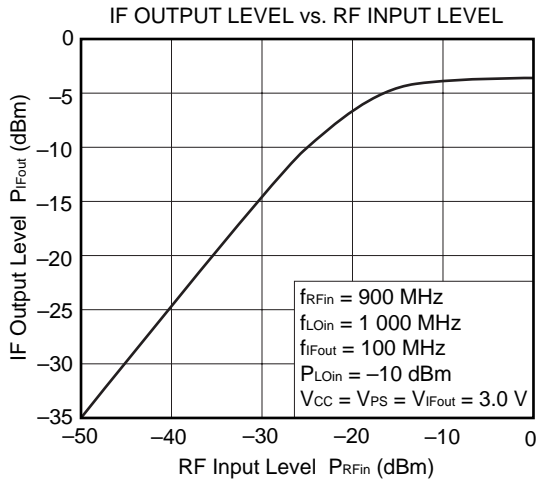

★ IF 100 MHz MATCHING

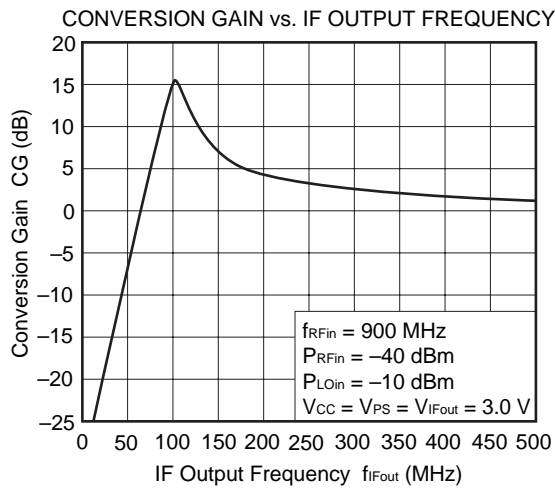
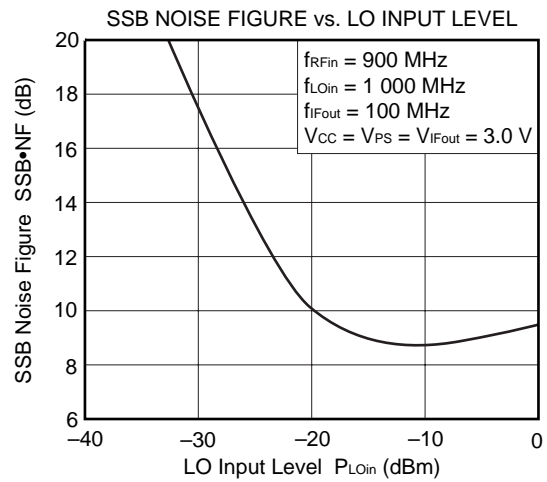
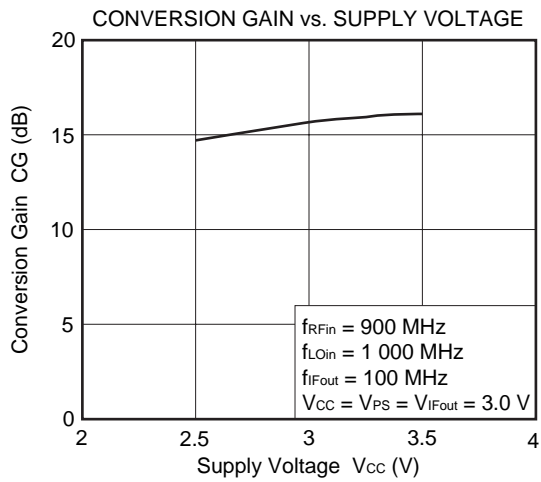

★ IF 100 MHz MATCHING

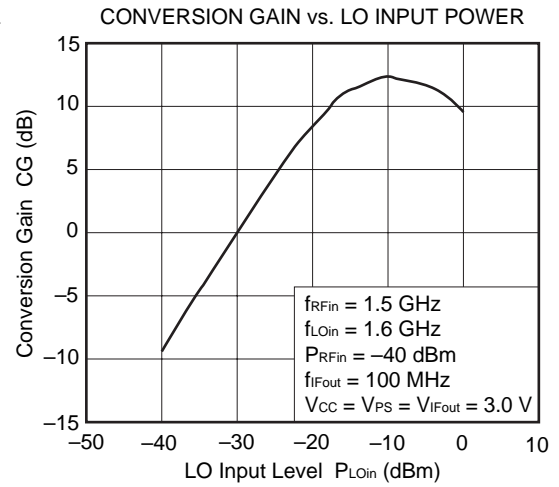
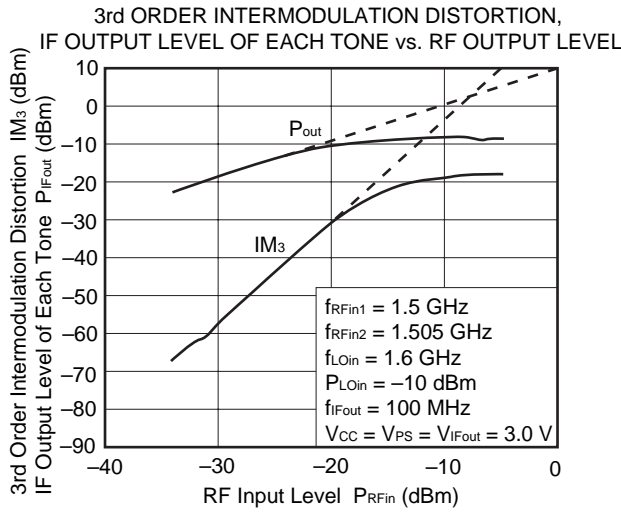
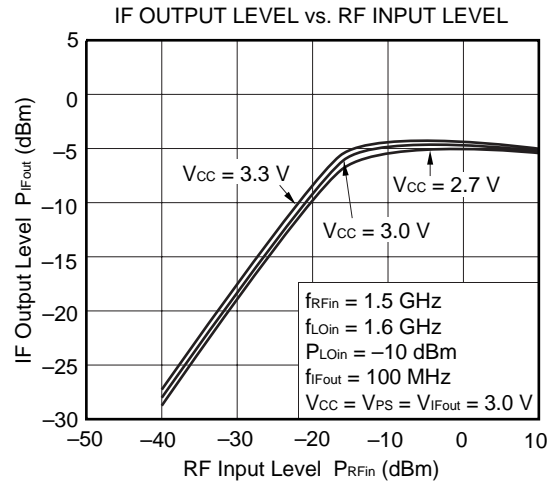
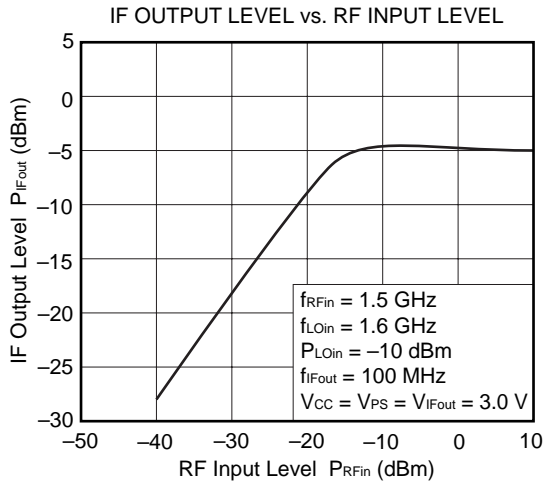

★ IF 100 MHz MATCHING

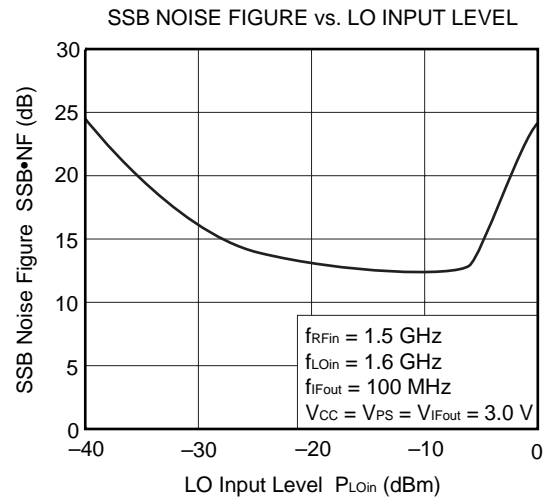
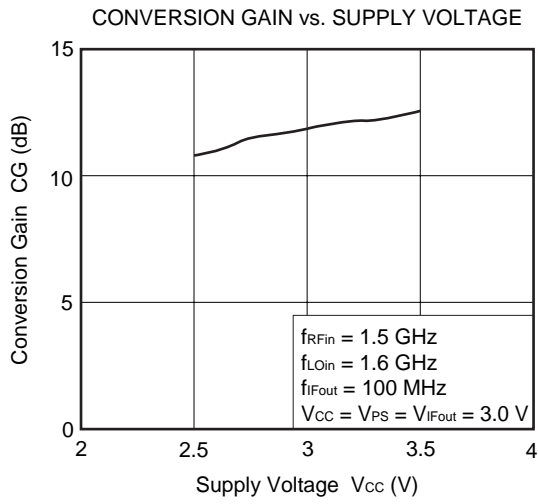

★ IF 240 MHz MATCHING

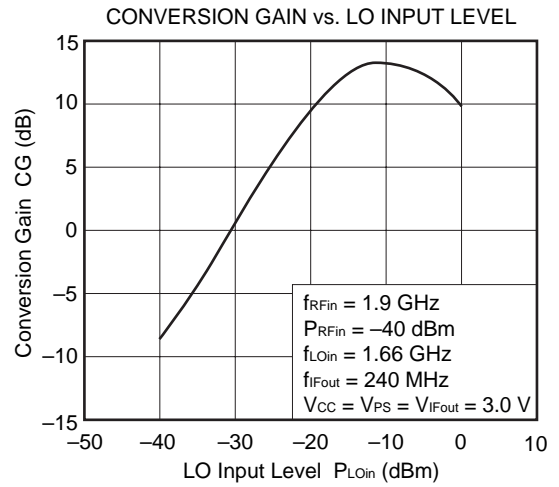
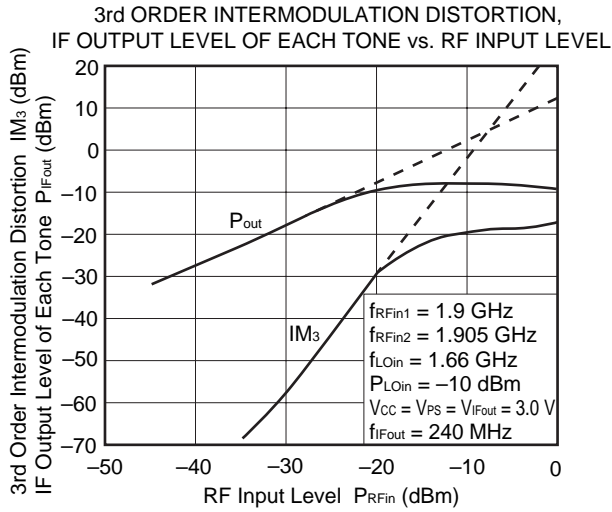
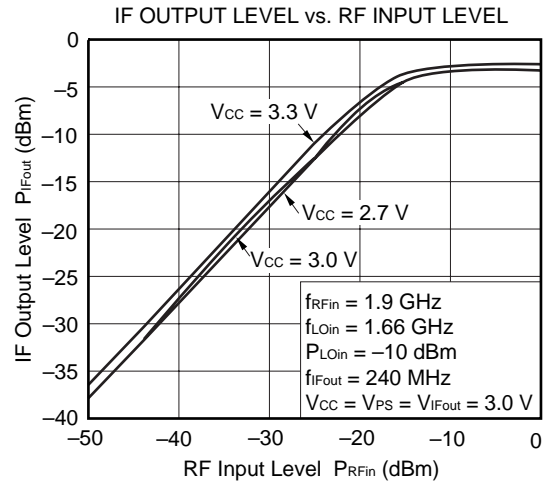
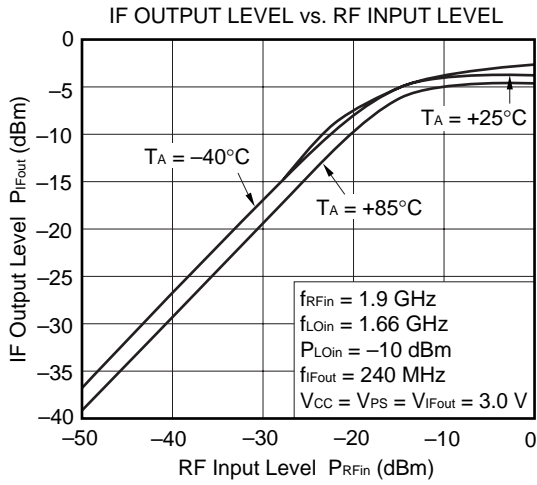

★ IF 240 MHz MATCHING

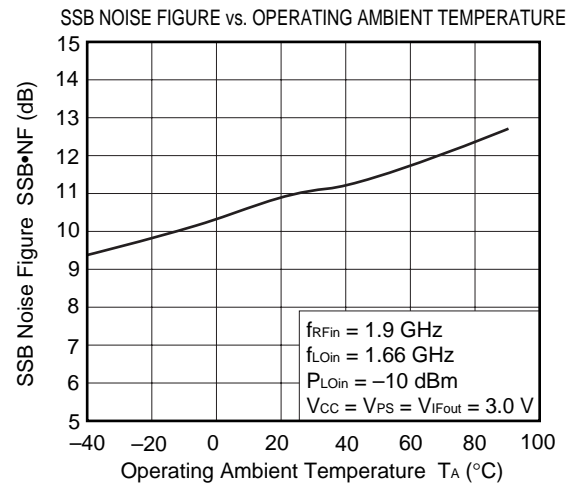
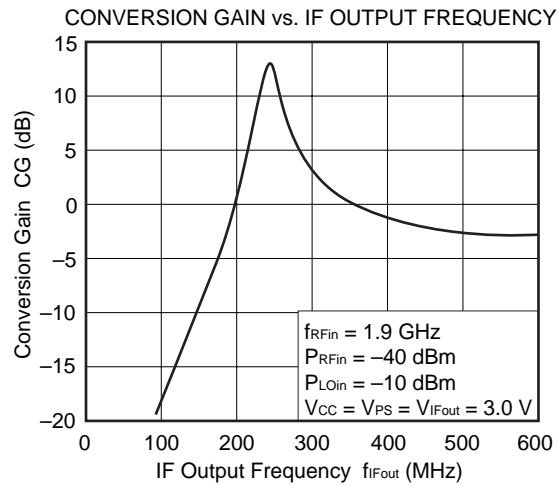
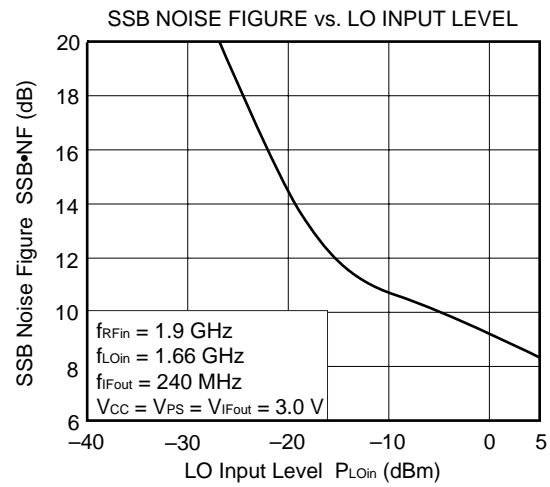
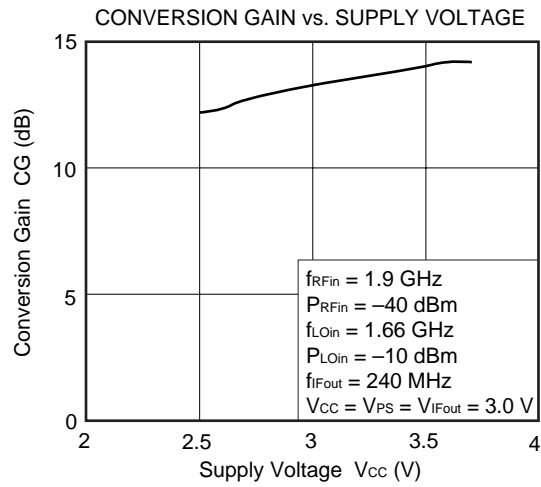

Remark The graphs indicate nominal characteristics.

PACKAGE DIMENSIONS

6 pin super minimold (Unit: mm)

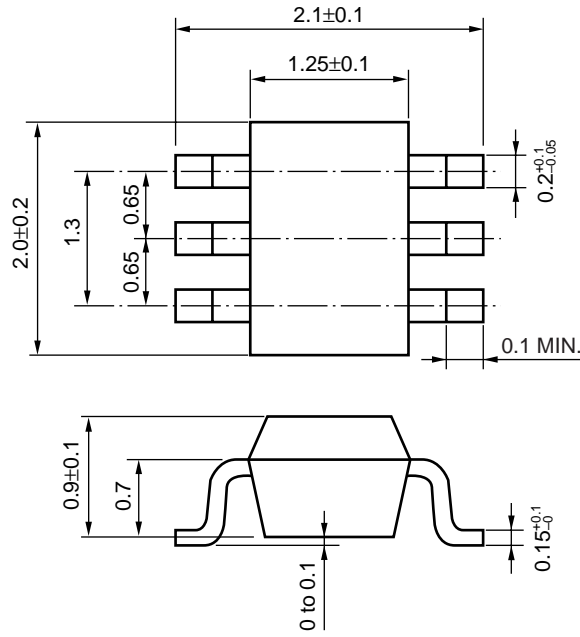

NOTE ON CORRECT USE

- (1) Observe precautions for handling because of electro-static sensitive devices.
- (2) Form a ground pattern as widely as possible to minimize ground impedance (to prevent undesired oscillation).
Keep the track length of the ground pins as short as possible.
- (3) The bypass capacitor (e.g. 1 000 pF) should be attached to the V_{CC} pin.
- (4) The matching circuit should be externally attached to the IF output pin.
- (5) The DC cut capacitor must be each attached to the input and output pins.

RECOMMENDED SOLDERING CONDITIONS

This product should be soldered under the following recommended conditions. For soldering methods and conditions other than those recommended below, contact your NEC sales representative.

Soldering Method	Soldering Conditions	Recommended Condition Symbol
Infrared Reflow	Package peak temperature: 235°C or below Time: 30 seconds or less (at 210°C) Count: 3, Exposure limit: None ^{Note}	IR35-00-3
VPS	Package peak temperature: 215°C or below Time: 40 seconds or less (at 200°C) Count: 3, Exposure limit: None ^{Note}	VP15-00-3
Wave Soldering	Soldering bath temperature: 260°C or below Time: 10 seconds or less Count: 1, Exposure limit: None ^{Note}	WS60-00-1
Partial Heating	Pin temperature: 300°C Time: 3 seconds or less (per side of device) Exposure limit: None ^{Note}	—

Note After opening the dry pack, keep it in a place below 25°C and 65% RH for the allowable storage period.

Caution Do not use different soldering methods together (except for partial heating).

For details of recommended soldering conditions for surface mounting, refer to information document SEMICONDUCTOR DEVICE MOUNTING TECHNOLOGY MANUAL (C10535E).

[MEMO]

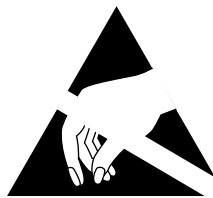

ATTENTION

OBSERVE PRECAUTIONS
FOR HANDLING
ELECTROSTATIC
SENSITIVE
DEVICES

NESAT (NEC Silicon Advanced Technology) is a trademark of NEC Corporation.

- **The information in this document is current as of June, 2000. The information is subject to change without notice. For actual design-in, refer to the latest publications of NEC's data sheets or data books, etc., for the most up-to-date specifications of NEC semiconductor products. Not all products and/or types are available in every country. Please check with an NEC sales representative for availability and additional information.**
- No part of this document may be copied or reproduced in any form or by any means without prior written consent of NEC. NEC assumes no responsibility for any errors that may appear in this document.
- NEC does not assume any liability for infringement of patents, copyrights or other intellectual property rights of third parties by or arising from the use of NEC semiconductor products listed in this document or any other liability arising from the use of such products. No license, express, implied or otherwise, is granted under any patents, copyrights or other intellectual property rights of NEC or others.
- Descriptions of circuits, software and other related information in this document are provided for illustrative purposes in semiconductor product operation and application examples. The incorporation of these circuits, software and information in the design of customer's equipment shall be done under the full responsibility of customer. NEC assumes no responsibility for any losses incurred by customers or third parties arising from the use of these circuits, software and information.
- While NEC endeavours to enhance the quality, reliability and safety of NEC semiconductor products, customers agree and acknowledge that the possibility of defects thereof cannot be eliminated entirely. To minimize risks of damage to property or injury (including death) to persons arising from defects in NEC semiconductor products, customers must incorporate sufficient safety measures in their design, such as redundancy, fire-containment, and anti-failure features.
- NEC semiconductor products are classified into the following three quality grades:
 "Standard", "Special" and "Specific". The "Specific" quality grade applies only to semiconductor products developed based on a customer-designated "quality assurance program" for a specific application. The recommended applications of a semiconductor product depend on its quality grade, as indicated below. Customers must check the quality grade of each semiconductor product before using it in a particular application.
 "Standard": Computers, office equipment, communications equipment, test and measurement equipment, audio and visual equipment, home electronic appliances, machine tools, personal electronic equipment and industrial robots
 "Special": Transportation equipment (automobiles, trains, ships, etc.), traffic control systems, anti-disaster systems, anti-crime systems, safety equipment and medical equipment (not specifically designed for life support)
 "Specific": Aircraft, aerospace equipment, submersible repeaters, nuclear reactor control systems, life support systems and medical equipment for life support, etc.

The quality grade of NEC semiconductor products is "Standard" unless otherwise expressly specified in NEC's data sheets or data books, etc. If customers wish to use NEC semiconductor products in applications not intended by NEC, they must contact an NEC sales representative in advance to determine NEC's willingness to support a given application.

(Note)

- (1) "NEC" as used in this statement means NEC Corporation and also includes its majority-owned subsidiaries.
- (2) "NEC semiconductor products" means any semiconductor product developed or manufactured by or for NEC (as defined above).