

MONOLITHIC DUAL H BRIDGE DRIVER CIRCUIT

DESCRIPTION

The μ PD16818 is a monolithic dual H bridge driver IC which uses N-channel power MOS FETs in its output stage. By employing the power MOS FETs for the output stage, this driver circuit has a substantially improved saturation voltage and power consumption as compared with conventional driver circuits that use bipolar transistors.

In addition, the drive current can be adjusted by an external resistor in power-saving mode.

The μ PD16818 is therefore ideal as the driver circuit of a 2-phase excitation, bipolar-driven stepping motor for the head actuator of an FDD.

FEATURES

- Compatible with 3V-/5V- supply voltage
- Pin compatible with μ PD16803
- Low ON resistance (sum of ON resistors of top and bottom MOS FETs)
 - $R_{ON1} = 1.2 \Omega$ ($V_M = 3.0$ V)
 - $R_{ON2} = 1.0 \Omega$ ($V_M = 5.0$ V)
- Low current consumption: $I_{DD} = 0.4$ mA TYP. ($V_{DD} = 2.7$ V to 3.6 V)
- Stop mode function that turns OFF all output MOS FETs
- Drive current can be set in power-saving mode (set by external resistor)
- Compact surface mount package

ORDERING INFORMATION

Part Number	Package
μ PD16818GS	20-pin plastic SOP (7.62 mm (300))

ABSOLUTE MAXIMUM RATINGS ($T_A = 25^\circ\text{C}$)

Parameter		Symbol	Condition	Rating	Unit
Supply voltage	Motor block	V_M		-0.5 to +7.0	V
	Control block	V_{DD}		-0.5 to +7.0	
Power consumption	μ PD16818GS	P_{D1}		1.0 ^{Note 1}	W
		P_{D2}		1.25 ^{Note 2}	
Instantaneous H bridge drive current		I_D (pulse)	$PW \leq 5$ ms, Duty ≤ 40 %	± 1.0 ^{Note 2}	A
Input voltage		V_{IN}		-0.5 to $V_{DD} + 0.5$	V
Operating temperature range		T_A		0 to 60	$^\circ\text{C}$
Operation junction temperature		T_J (MAX)		150	$^\circ\text{C}$
Storage temperature range		T_{stg}		-55 to +150	$^\circ\text{C}$

Notes 1. IC only

2. When mounted on a glass epoxy printed circuit board (100 mm \times 100 mm \times 1 mm)

The information in this document is subject to change without notice. Before using this document, please confirm that this is the latest version.
Not all products and/or types are available in every country. Please check with an NEC Electronics sales representative for availability and additional information.

RECOMMENDED OPERAING CONDITIONS

Parameter		Symbol	MIN.	TYP.	MAX.	Unit
Supply voltage	Motor block	V _M	2.7		6.0	V
	Control block	V _{DD}	2.7		6.0	
Rx pin connection resistance		R _X	2			kΩ
H bridge drive current (V _{DD} = V _M = 3 V) ^{Note}		μPD16818GS	I _{DR}		430	mA
Charge pump capacitor capacitance		C ₁ -C ₃	5		20	nF
Operating temperature		T _A	0		60	°C

Note When mounted on a glass epoxy printed circuit board (100 mm × 100 mm × 1 mm)

ELECTRICAL SPECIFICATIONS (Within recommended operating conditions unless otherwise specified)

V_{DD} = V_M = 4.0 V to 6.0 V

Parameter	Symbol	Conditions	MIN.	TYP.	MAX.	Unit
OFF V _M pin current	I _M	INC pin low V _M = V _{DD} = 6 V			1.0	μA
V _{DD} pin current	I _{DD}	Note 1		1.0	2.0	mA
High-level input current (IN ₁ , IN ₂ , INC)	I _{IH1}	T _A = 25 °C, V _{IN} = V _{DD}			1.0	μA
		0 ≤ T _A ≤ 60 °C, V _{IN} = V _{DD}			2.0	
Low-level input current (IN ₁ , IN ₂ , INC)	I _{IL1}	T _A = 25 °C, V _{IN} = 0			-0.15	mA
		0 ≤ T _A ≤ 60 °C, V _{IN} = 0			-0.2	
PS pin high-level input current	I _{IH2}	T _A = 25 °C, V _{IN} = V _{DD}			0.15	mA
		0 ≤ T _A ≤ 60 °C, V _{IN} = V _{DD}			0.2	
PS pin low-level input voltage	I _{IL2}	T _A = 25 °C, V _{IN} = 0			-1.0	μA
		0 ≤ T _A ≤ 60 °C, V _{IN} = 0			-2.0	
Input pull-up resistance (IN ₁ , IN ₂ , INC)	R _{INU}	T _A = 25 °C	35	50	65	kΩ
		0 ≤ T _A ≤ 60 °C	25		75	
PS pin input pull-down resistance	R _{IND}	T _A = 25 °C	35	50	65	kΩ
		0 ≤ T _A ≤ 60 °C	25		75	
Control pin high-level input voltage	V _{IH}		3.0		V _{DD} + 0.3	V
Control pin low-level input voltage	V _{IL}		-0.3		0.8	V
H bridge ON resistance ^{Note 2}	R _{ON2}	V _{DD} = V _M = 5 V		1.0	2.0	Ω
R _{ON} relative accuracy	ΔR _{ON}	Excitation direction <1>, <3>			±15	%
		Excitation direction <2>, <4> ^{Note 3}			±5	
Charge pump circuit turn ON time	t _{ONG}	V _{DD} = V _M = 5 V		0.3	2.0	ms
H bridge turn ON time	t _{ONH}	C ₁ = C ₂ = C ₃ = 10nF R _M = 20 Ω			2.0	μs
H bridge turn OFF time	t _{OFFH}				5.0	μs

- Notes 1.** When IN₁ = IN₂ = INC = "H", PS = "L"
- 2.** Sum of ON resistances of top and bottom MOS FETs
- 3.** For the excitation direction, refer to **FUNCTION TABLE**.

ELECTRICAL SPECIFICATIONS (Within recommended operating conditions unless otherwise specified)

V_{DD} = V_M = 2.7 V to 3.6 V

Parameter	Symbol	Conditions	MIN.	TYP.	MAX.	Unit
OFF V _M pin current	I _M	INC pin low V _M = V _{DD} = 3.6 V			1.0	μA
V _{DD} pin current	I _{DD}	Note 1		0.4	1.0	mA
High-level input current (IN ₁ , IN ₂ , INC)	I _{IH1}	T _A = 25 °C, V _{IN} = V _{DD}			1.0	μA
		0 ≤ T _A ≤ 60 °C, V _{IN} = V _{DD}			2.0	
Low-level input current (IN ₁ , IN ₂ , INC)	I _{IL1}	T _A = 25 °C, V _{IN} = 0			-0.09	mA
		0 ≤ T _A ≤ 60 °C, V _{IN} = 0			-0.12	
PS pin high-level input current	I _{IH2}	T _A = 25 °C, V _{IN} = V _{DD}			0.09	mA
		0 ≤ T _A ≤ 60 °C, V _{IN} = V _{DD}			0.12	
PS pin low-level input voltage	I _{IL2}	T _A = 25 °C, V _{IN} = 0			-1.0	μA
		0 ≤ T _A ≤ 60 °C, V _{IN} = 0			-2.0	
Input pull-up resistance (IN ₁ , IN ₂ , INC)	R _{INU}	T _A = 25 °C	35	50	65	kΩ
		0 ≤ T _A ≤ 60 °C	25		75	
PS pin input pull-down resistance	R _{IND}	T _A = 25 °C	35	50	65	kΩ
		0 ≤ T _A ≤ 60 °C	25		75	
Control pin high-level input voltage	V _{IH}		2.0		V _{DD} + 0.3	V
Control pin low-level input voltage	V _{IL}		-0.3		0.8	V
H bridge ON resistance ^{Note 2}	R _{ON1}	V _{DD} = V _M = 3 V		1.2	2.4	Ω
R _{ON} relative accuracy	ΔR _{ON}	Excitation direction <1>, <3>			±15	%
		Excitation direction <2>, <4> ^{Note 3}			±5	
V _x voltage in power-saving mode ^{Note 4}	V _x	V _{DD} = V _M = 3 V R _x = 270 kΩ	1.0	1.2	1.4	V
V _x relative accuracy in power-saving mode	ΔV _x	Excitation direction <1>, <3>			±5	%
		Excitation direction <2>, <4>			±5	
Charge pump circuit turn ON time	t _{ONG}	V _{DD} = V _M = 3 V		0.3	2.0	ms
H bridge turn ON time	t _{ONH}	C ₁ = C ₂ = C ₃ = 10nF			2.0	μs
H bridge turn OFF time	t _{OFFH}	R _M = 20 Ω			5.0	μs

Notes 1. When IN₁ = IN₂ = INC = “H”, PS = “L”

2. Sum of ON resistances of top and bottom MOS FETs

3. For the excitation direction, refer to **FUNCTION TABLE**.

4. V_x is a voltage at point A (FORWARD) or B (REVERSE) of the H bridge in **FUNCTION TABLE**.

PIN CONFIGURATION (Top View)

20-pin plastic SOP (7.62 mm (300))

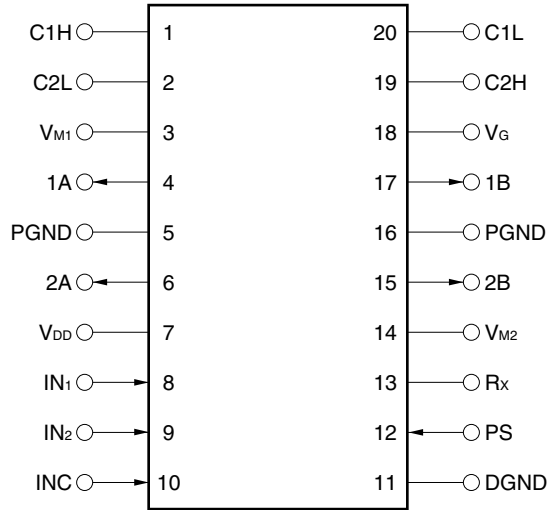

FUNCTION TABLE

Excitation Direction	INc	IN1	IN2	H1	H2
<1>	H	H	H	F	F
<2>	H	L	H	R	F
<3>	H	L	L	R	R
<4>	H	H	L	F	R
-	L	×	×	Stop	

F: FORWARD
R: REVERSE

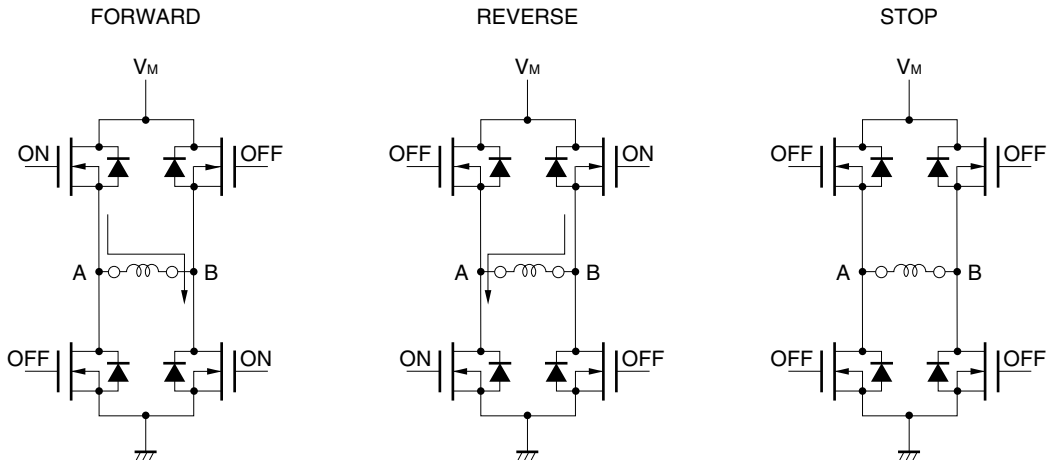
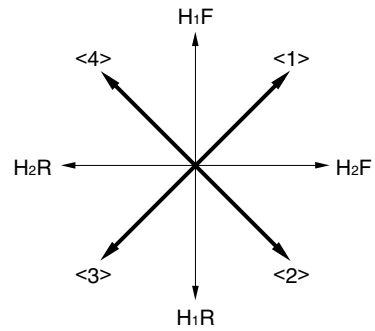

BLOCK DIAGRAM

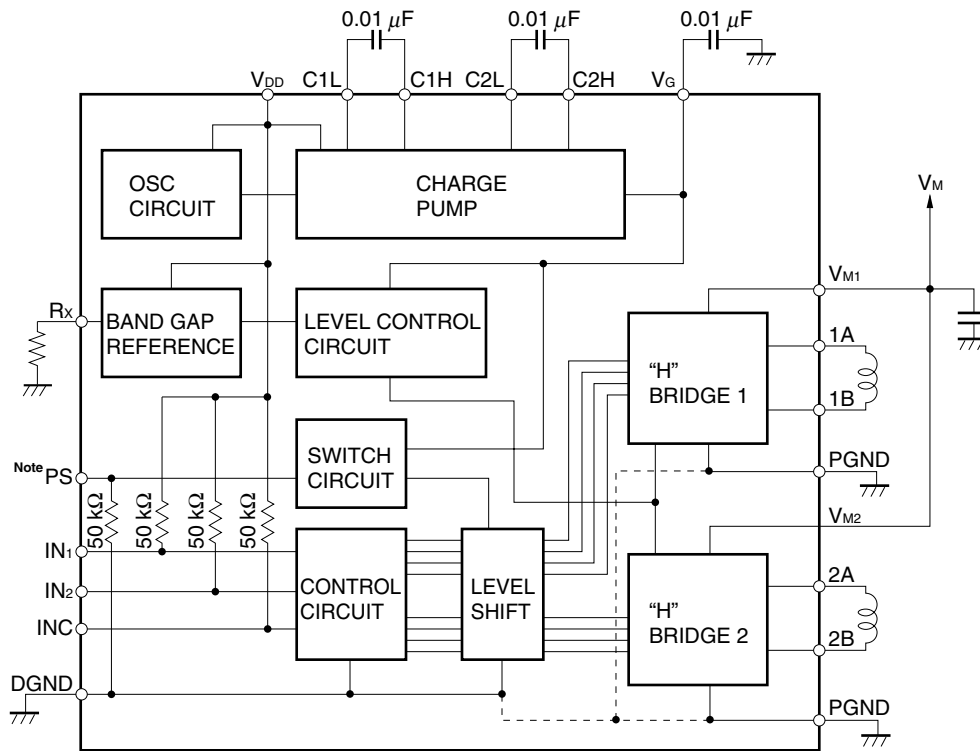

Note The power-saving mode is set when the PS pin goes high. In this mode, the voltage of the charge pump circuit is lowered and the ON resistance of the H bridge driver transistor increases, limiting the current.

Remark ----- is connected in diffusion layer.

CHARACTERISTIC CURVES

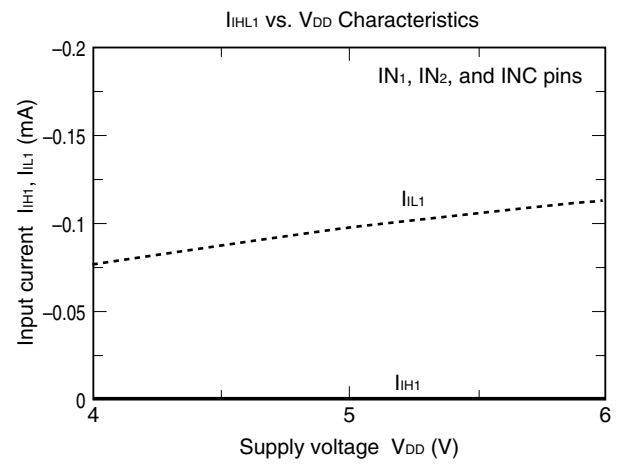
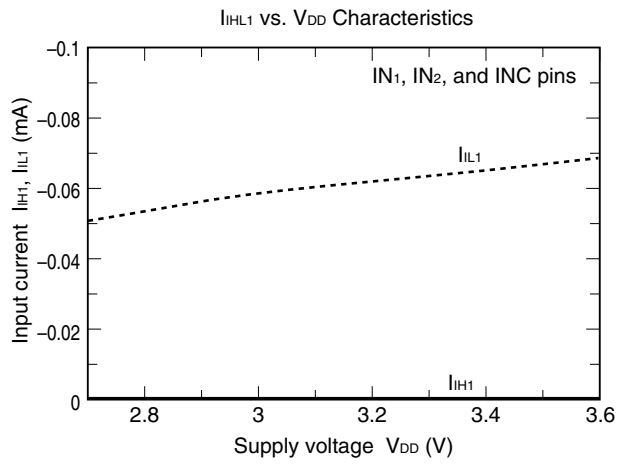
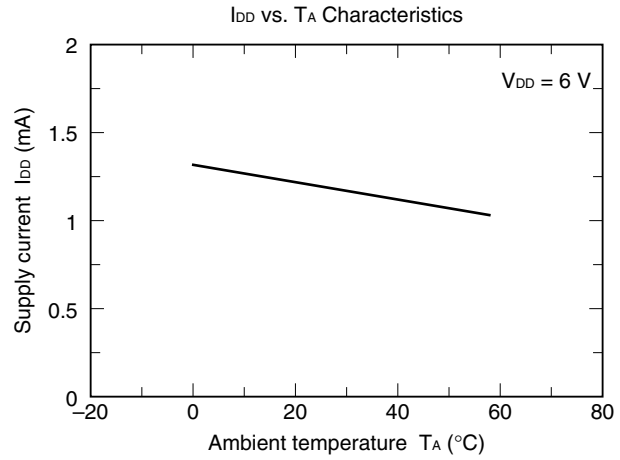
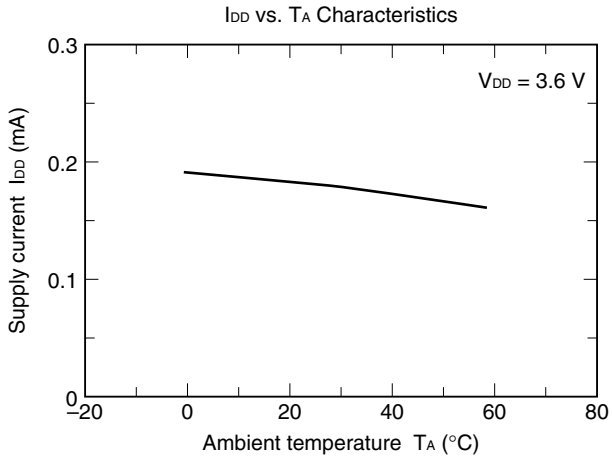

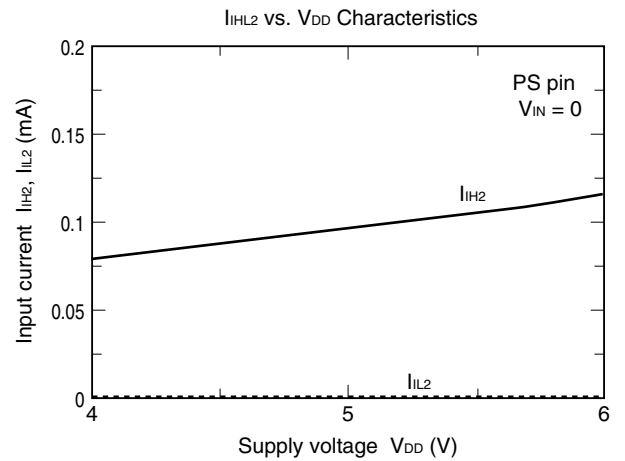
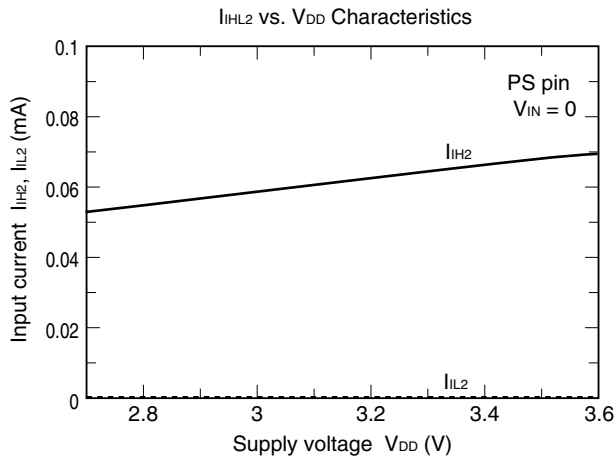
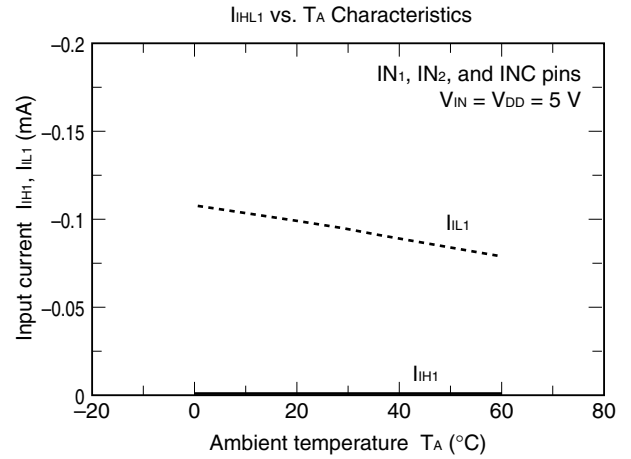
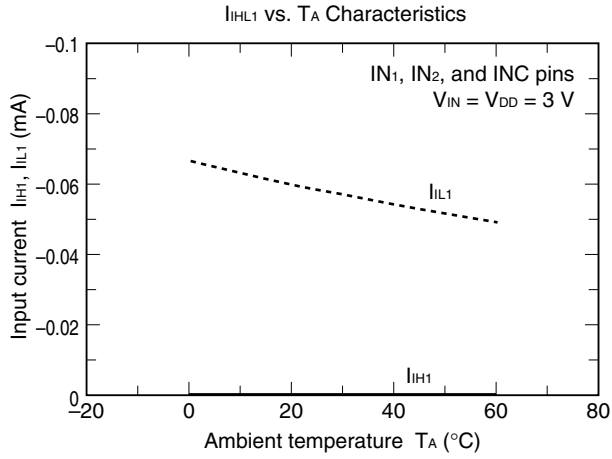

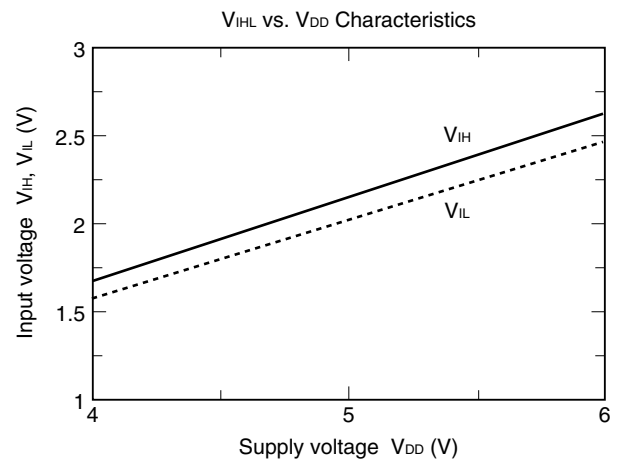
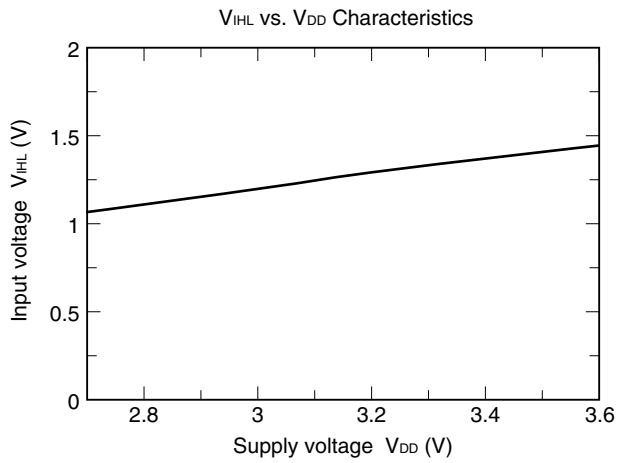
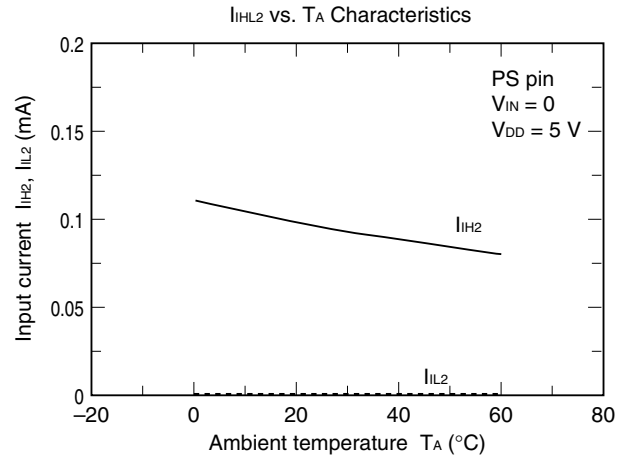
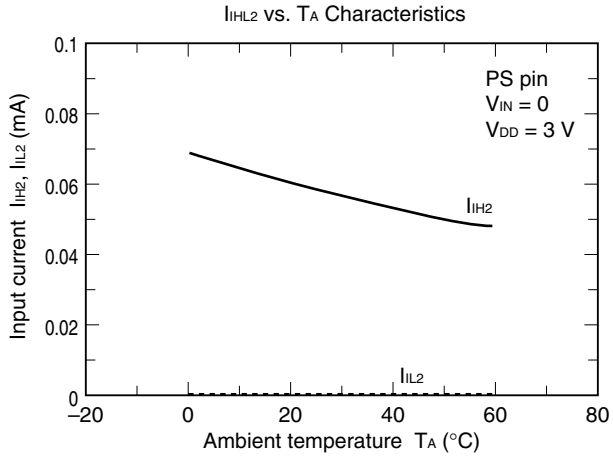

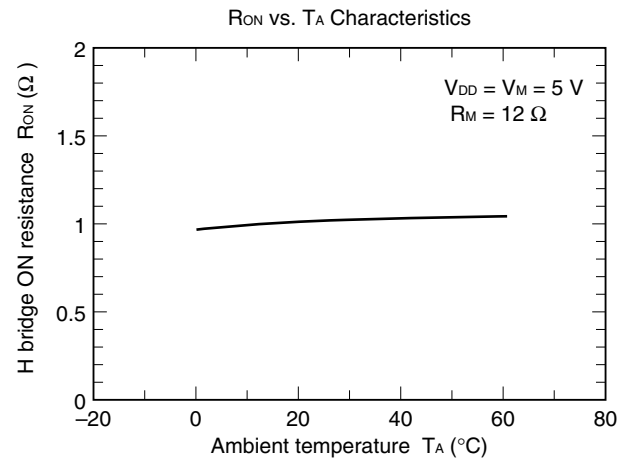
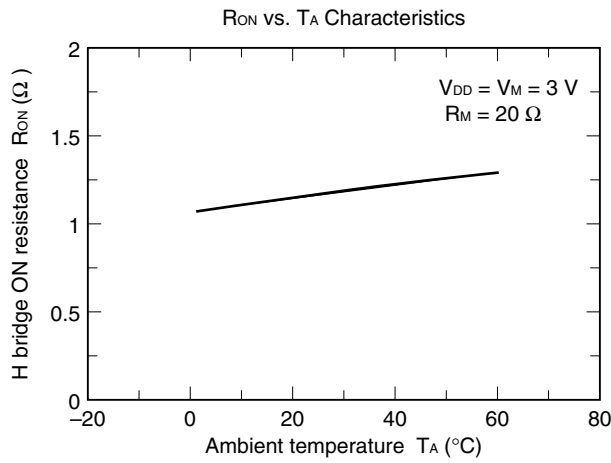
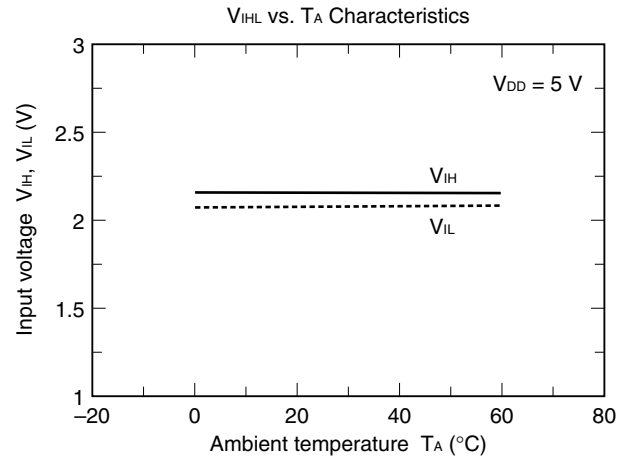
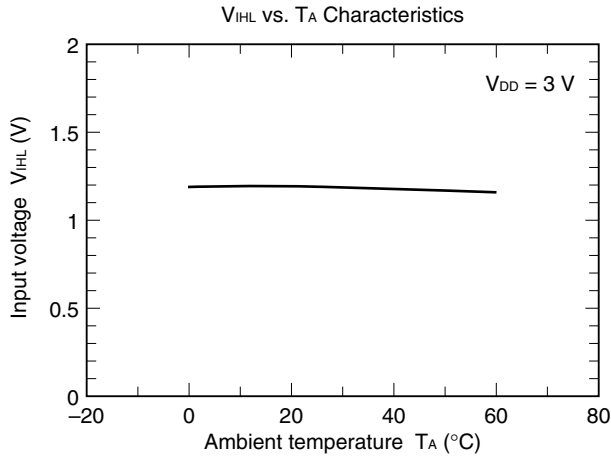

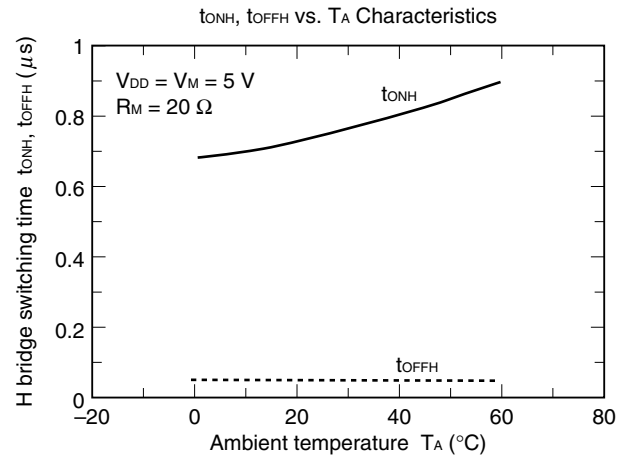
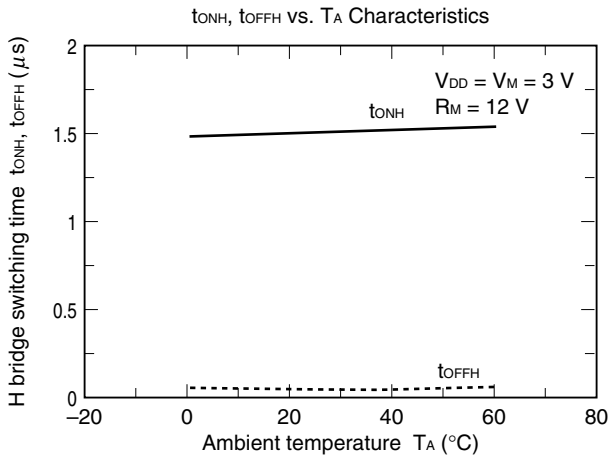
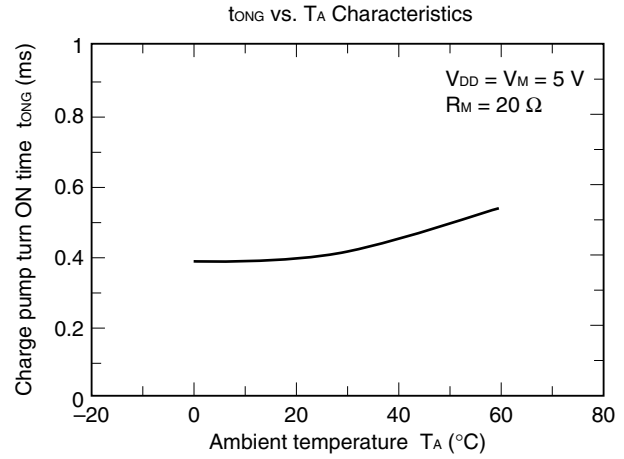
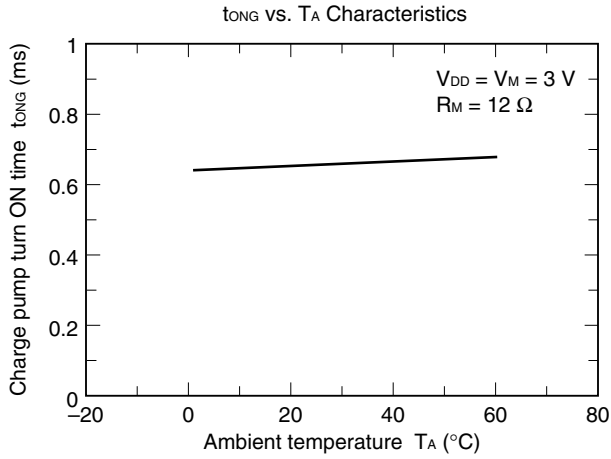

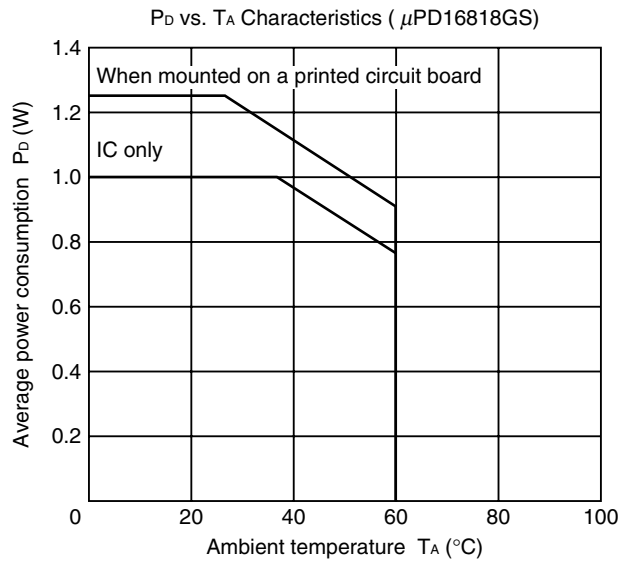
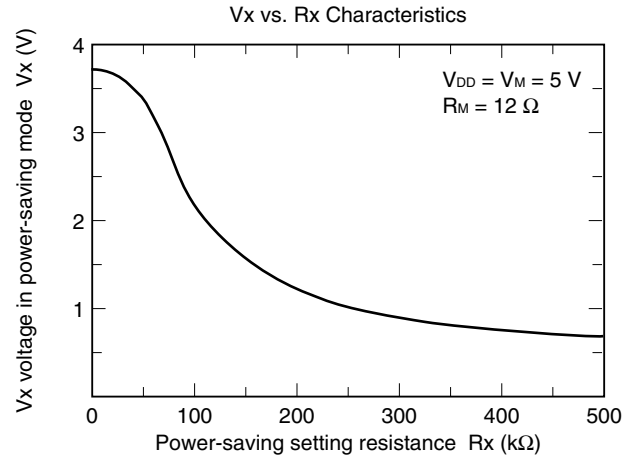
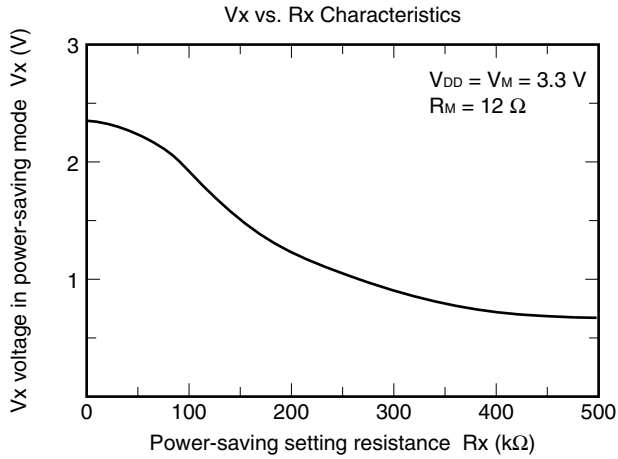

PACKAGE DRAWING

20-PIN PLASTIC SOP (7.62 mm (300))

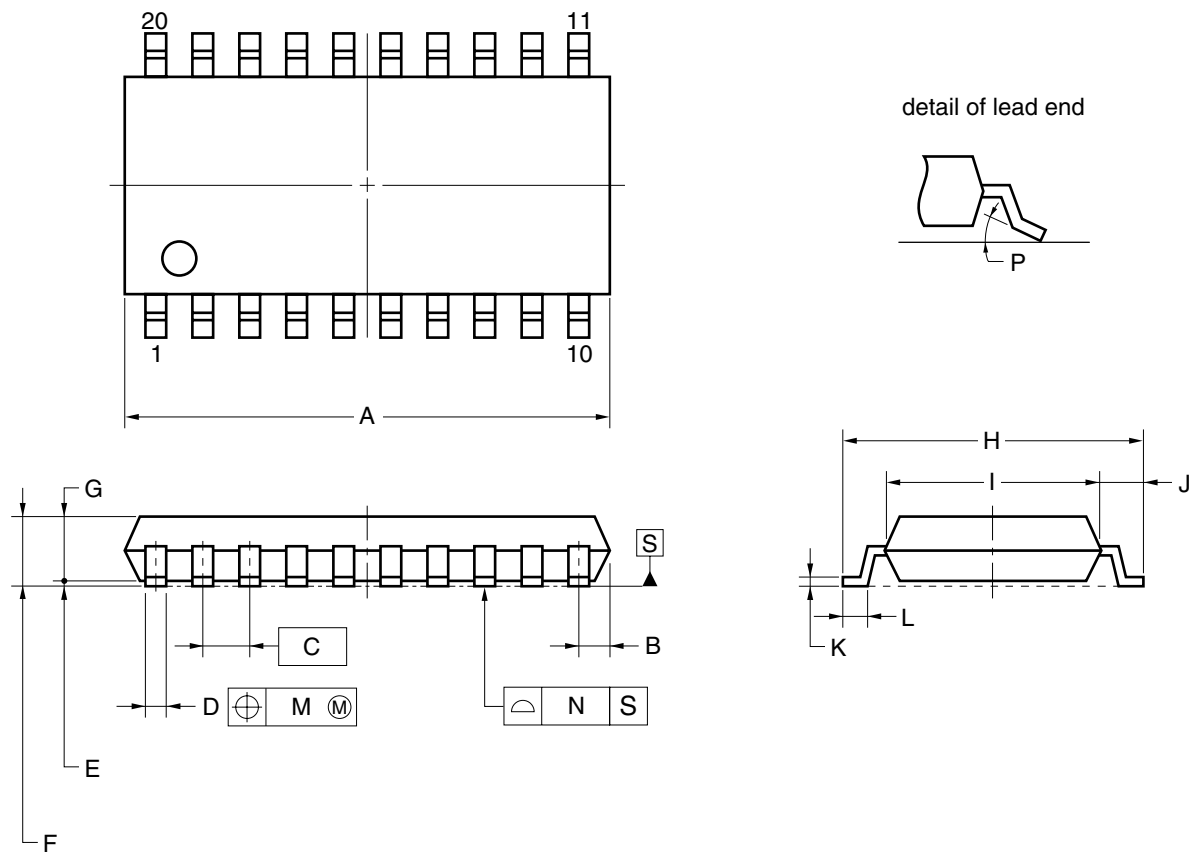

NOTE

Each lead centerline is located within 0.12 mm of its true position (T.P.) at maximum material condition.

ITEM	MILLIMETERS
A	12.7±0.3
B	0.78 MAX.
C	1.27 (T.P.)
D	0.42 ^{+0.08} _{-0.07}
E	0.1±0.1
F	1.8 MAX.
G	1.55±0.05
H	7.7±0.3
I	5.6±0.2
J	1.1
K	0.22 ^{+0.08} _{-0.07}
L	0.6±0.2
M	0.12
N	0.10
P	3° ^{+7°} _{-3°}

P20GM-50-300B, C-7

RECOMMENDED SOLDERING CONDITIONS

The μPD16818 should be soldered and mounted under the following recommended conditions.

For soldering methods and conditions other than those recommended below, contact an NEC Electronics sales representative.

For technical information, see the following website.

Semiconductor Device Mount Manual (<http://www.necel.com/pkg/en/mount/index.html>)

Surface Mount Type

μPD16818GS 20-pin plastic SOP (7.62 mm (300))

Soldering Method	Soldering Conditions	Symbol of Recommended Soldering
Infrared reflow	Package peak temperature: 235°C, Time: 30 seconds MAX.(210°C MIN.), Number of times: 3 MAX., Number of days: None ^{Note} , Flux: Rosin-based flux with little chlorine component (chlorine: 0.2 Wt% MAX.)	IR35-00-3
VPS	Package peak temperature: 215°C, Time: 40 seconds MAX.(200°C MIN.), Number of times: 3 MAX., Number of days: None ^{Note} , Flux: Rosin-based flux with little chlorine component (chlorine: 0.2 Wt% MAX.)	VP15-00-3
Wave soldering	Package peak temperature: 260°C, Time: 10 seconds MAX., Preheating temperature: 120 °C MAX., Number of times: 1, Flux: Rosin-based flux with little chlorine component (chlorine: 0.2 Wt% MAX.)	WS60-00-1

Note Number of days in storage after the dry pack has been opened. The storage conditions are at 25 °C, 65 % RH MAX.

Caution Do not use two or more soldering methods in combination.

NOTES FOR CMOS DEVICES

① VOLTAGE APPLICATION WAVEFORM AT INPUT PIN

Waveform distortion due to input noise or a reflected wave may cause malfunction. If the input of the CMOS device stays in the area between V_{IL} (MAX) and V_{IH} (MIN) due to noise, etc., the device may malfunction. Take care to prevent chattering noise from entering the device when the input level is fixed, and also in the transition period when the input level passes through the area between V_{IL} (MAX) and V_{IH} (MIN).

② HANDLING OF UNUSED INPUT PINS

Unconnected CMOS device inputs can be cause of malfunction. If an input pin is unconnected, it is possible that an internal input level may be generated due to noise, etc., causing malfunction. CMOS devices behave differently than Bipolar or NMOS devices. Input levels of CMOS devices must be fixed high or low by using pull-up or pull-down circuitry. Each unused pin should be connected to V_{DD} or GND via a resistor if there is a possibility that it will be an output pin. All handling related to unused pins must be judged separately for each device and according to related specifications governing the device.

③ PRECAUTION AGAINST ESD

A strong electric field, when exposed to a MOS device, can cause destruction of the gate oxide and ultimately degrade the device operation. Steps must be taken to stop generation of static electricity as much as possible, and quickly dissipate it when it has occurred. Environmental control must be adequate. When it is dry, a humidifier should be used. It is recommended to avoid using insulators that easily build up static electricity. Semiconductor devices must be stored and transported in an anti-static container, static shielding bag or conductive material. All test and measurement tools including work benches and floors should be grounded. The operator should be grounded using a wrist strap. Semiconductor devices must not be touched with bare hands. Similar precautions need to be taken for PW boards with mounted semiconductor devices.

④ STATUS BEFORE INITIALIZATION

Power-on does not necessarily define the initial status of a MOS device. Immediately after the power source is turned ON, devices with reset functions have not yet been initialized. Hence, power-on does not guarantee output pin levels, I/O settings or contents of registers. A device is not initialized until the reset signal is received. A reset operation must be executed immediately after power-on for devices with reset functions.

⑤ POWER ON/OFF SEQUENCE

In the case of a device that uses different power supplies for the internal operation and external interface, as a rule, switch on the external power supply after switching on the internal power supply. When switching the power supply off, as a rule, switch off the external power supply and then the internal power supply. Use of the reverse power on/off sequences may result in the application of an overvoltage to the internal elements of the device, causing malfunction and degradation of internal elements due to the passage of an abnormal current.

The correct power on/off sequence must be judged separately for each device and according to related specifications governing the device.

⑥ INPUT OF SIGNAL DURING POWER OFF STATE

Do not input signals or an I/O pull-up power supply while the device is not powered. The current injection that results from input of such a signal or I/O pull-up power supply may cause malfunction and the abnormal current that passes in the device at this time may cause degradation of internal elements. Input of signals during the power off state must be judged separately for each device and according to related specifications governing the device.

• **The information in this document is current as of September, 2004. The information is subject to change without notice. For actual design-in, refer to the latest publications of NEC Electronics data sheets or data books, etc., for the most up-to-date specifications of NEC Electronics products. Not all products and/or types are available in every country. Please check with an NEC Electronics sales representative for availability and additional information.**

- No part of this document may be copied or reproduced in any form or by any means without the prior written consent of NEC Electronics. NEC Electronics assumes no responsibility for any errors that may appear in this document.
- NEC Electronics does not assume any liability for infringement of patents, copyrights or other intellectual property rights of third parties by or arising from the use of NEC Electronics products listed in this document or any other liability arising from the use of such products. No license, express, implied or otherwise, is granted under any patents, copyrights or other intellectual property rights of NEC Electronics or others.
- Descriptions of circuits, software and other related information in this document are provided for illustrative purposes in semiconductor product operation and application examples. The incorporation of these circuits, software and information in the design of a customer's equipment shall be done under the full responsibility of the customer. NEC Electronics assumes no responsibility for any losses incurred by customers or third parties arising from the use of these circuits, software and information.
- While NEC Electronics endeavors to enhance the quality, reliability and safety of NEC Electronics products, customers agree and acknowledge that the possibility of defects thereof cannot be eliminated entirely. To minimize risks of damage to property or injury (including death) to persons arising from defects in NEC Electronics products, customers must incorporate sufficient safety measures in their design, such as redundancy, fire-containment and anti-failure features.
- NEC Electronics products are classified into the following three quality grades: "Standard", "Special" and "Specific".

The "Specific" quality grade applies only to NEC Electronics products developed based on a customer-designated "quality assurance program" for a specific application. The recommended applications of an NEC Electronics product depend on its quality grade, as indicated below. Customers must check the quality grade of each NEC Electronics product before using it in a particular application.

"Standard": Computers, office equipment, communications equipment, test and measurement equipment, audio and visual equipment, home electronic appliances, machine tools, personal electronic equipment and industrial robots.

"Special": Transportation equipment (automobiles, trains, ships, etc.), traffic control systems, anti-disaster systems, anti-crime systems, safety equipment and medical equipment (not specifically designed for life support).

"Specific": Aircraft, aerospace equipment, submersible repeaters, nuclear reactor control systems, life support systems and medical equipment for life support, etc.

The quality grade of NEC Electronics products is "Standard" unless otherwise expressly specified in NEC Electronics data sheets or data books, etc. If customers wish to use NEC Electronics products in applications not intended by NEC Electronics, they must contact an NEC Electronics sales representative in advance to determine NEC Electronics' willingness to support a given application.

(Note)

- (1) "NEC Electronics" as used in this statement means NEC Electronics Corporation and also includes its majority-owned subsidiaries.
- (2) "NEC Electronics products" means any product developed or manufactured by or for NEC Electronics (as defined above).