

## Surface Mount Ultrafast Rectifier

**DO-214AC (SMA)**
**FEATURES**

- Low profile package
- Ideal for automated placement
- Glass passivated chip junction
- Ultrafast reverse recovery time
- Low switching losses, high efficiency
- High forward surge capability
- Meets MSL level 1, per J-STD-020, LF maximum peak of 260 °C
- Solder dip 260 °C, 40 s
- Component in accordance to RoHS 2002/95/EC and WEEE 2002/96/EC

**RoHS**  
COMPLIANT

**TYPICAL APPLICATIONS**

For use in high frequency rectification and freewheeling application in switching mode converters and inverters for consumer, computer, automotive and telecommunication.

**MECHANICAL DATA**

**Case:** DO-214AC (SMA)

Epoxy meets UL 94V-0 flammability rating

**Terminals:** Matte tin plated leads, solderable per J-STD-002 and JESD22-B102

E3 suffix for consumer grade, meets JESD 201 class 1A whisker test, HE3 suffix for high reliability grade (AEC Q101 qualified), meets JESD 201 class 2 whisker test

**Polarity:** Color band denotes cathode end

PRIMARY CHARACTERISTICS	
$I_{F(AV)}$	1.0 A
$V_{RRM}$	50 V to 1000 V
$I_{FSM}$	30 A
$t_{rr}$	50 ns, 75 ns
$V_F$	1.0 V, 1.7 V
$T_J \text{ max.}$	150 °C

MAXIMUM RATINGS ( $T_A = 25\text{ °C}$ unless otherwise noted)									
PARAMETER	SYMBOL	US1A	US1B	US1D	US1G	US1J	US1K	US1M	UNIT
Device marking code		UA	UB	UD	UG	UJ	UK	UM	
Maximum repetitive peak reverse voltage	$V_{RRM}$	50	100	200	400	600	800	1000	V
Maximum RMS voltage	$V_{RMS}$	35	70	140	280	420	560	700	V
Maximum DC blocking voltage	$V_{DC}$	50	100	200	400	600	800	1000	V
Maximum average forward rectified current at $T_L = 110\text{ °C}$	$I_{F(AV)}$	1.0							A
Peak forward surge current 8.3 ms single half sine-wave superimposed on rated load	$I_{FSM}$	30							A
Operating and storage temperature range	$T_J, T_{STG}$	- 55 to + 150							°C

<b>ELECTRICAL CHARACTERISTICS</b> ( $T_A = 25\text{ }^\circ\text{C}$ unless otherwise noted)										
PARAMETER	TEST CONDITIONS	SYMBOL	US1A	US1B	US1D	US1G	US1J	US1K	US1M	UNIT
Maximum instantaneous forward voltage <sup>(1)</sup>	1.0 A	$V_F$	1.0			1.7				V
Maximum DC reverse current at rated DC blocking voltage	$T_A = 25\text{ }^\circ\text{C}$ $T_A = 100\text{ }^\circ\text{C}$	$I_R$				10 50				$\mu\text{A}$
Maximum reverse recovery time	$I_F = 0.5\text{ A}$ , $I_R = 1.0\text{ A}$ , $I_{rr} = 0.25\text{ A}$	$t_{rr}$	50			75				ns
Typical junction capacitance	4.0 V, 1 MHz	$C_J$	15			10				pF

**Note:**

(1) Pulse test: 300  $\mu\text{s}$  pulse width, 1 % duty cycle

<b>THERMAL CHARACTERISTICS</b> ( $T_A = 25\text{ }^\circ\text{C}$ unless otherwise noted)										
PARAMETER	SYMBOL	US1A	US1B	US1D	US1G	US1J	US1K	US1M	UNIT	
Maximum thermal resistance <sup>(1)</sup>	$R_{\theta JA}$ $R_{\theta JL}$				75 27				$^\circ\text{C/W}$	

**Note:**

(1) P.C.B. mounted on 0.2 x 0.2" (5.0 x 5.0 mm) copper pad area

<b>ORDERING INFORMATION</b> (Example)				
PREFERRED P/N	UNIT WEIGHT (g)	PREFERRED PACKAGE CODE	BASE QUANTITY	DELIVERY MODE
US1J-E3/61T	0.064	61T	1800	7" diameter plastic tape and reel
US1J-E3/5AT	0.064	5AT	7500	13" diameter plastic tape and reel
US1JHE3/61T <sup>(1)</sup>	0.064	61T	1800	7" diameter plastic tape and reel
US1JHE3/5AT <sup>(1)</sup>	0.064	5AT	7500	13" diameter plastic tape and reel

**Note:**

(1) Automotive grade AEC Q101 qualified

## RATINGS AND CHARACTERISTICS CURVES

( $T_A = 25\text{ }^\circ\text{C}$  unless otherwise noted)

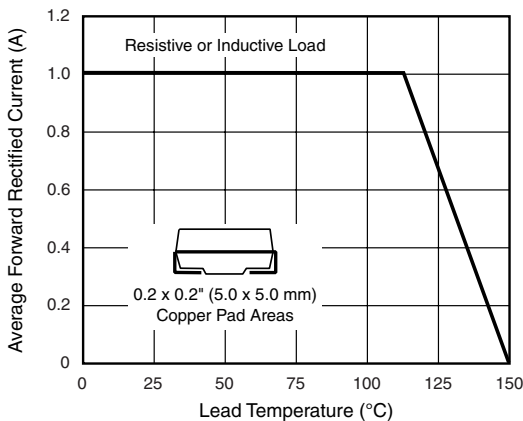

Figure 1. Forward Current Derating Curve

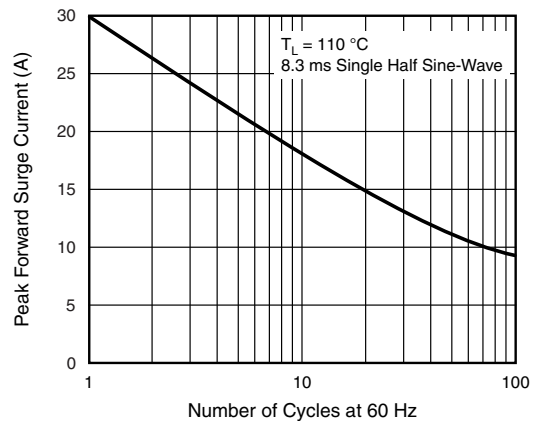

Figure 2. Maximum Non-Repetitive Peak Forward Surge Current

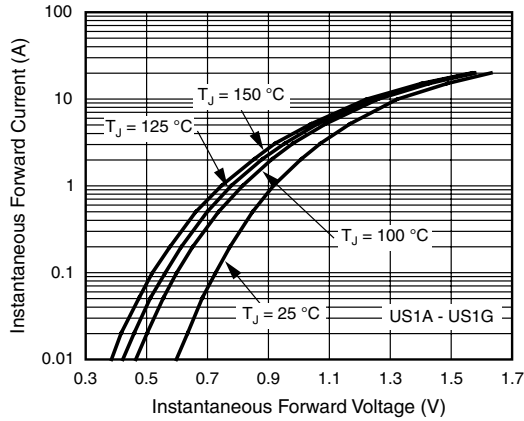

Figure 3. Typical Instantaneous Forward Characteristics

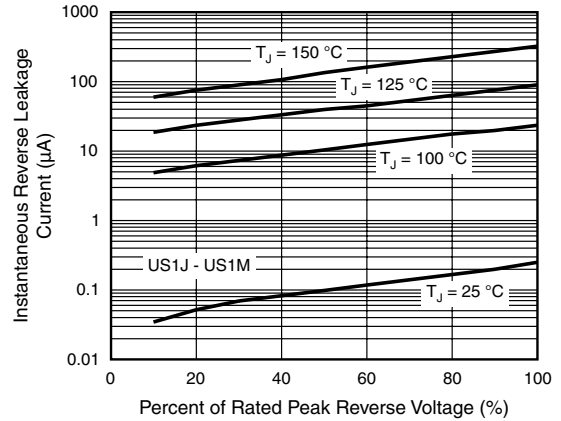

Figure 6. Typical Reverse Leakage Characteristics

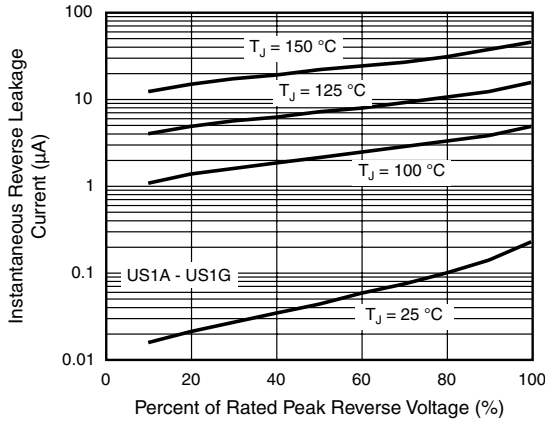

Figure 4. Typical Reverse Leakage Characteristics

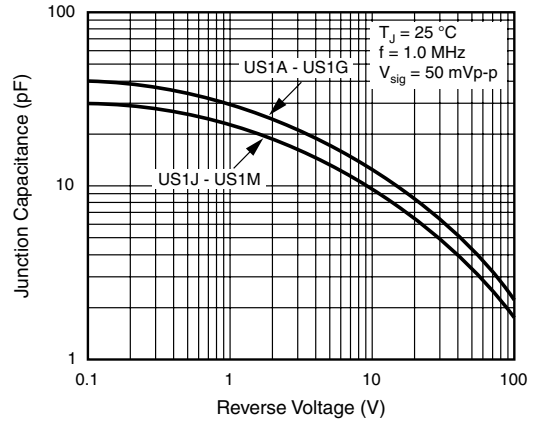

Figure 7. Typical Junction Capacitance

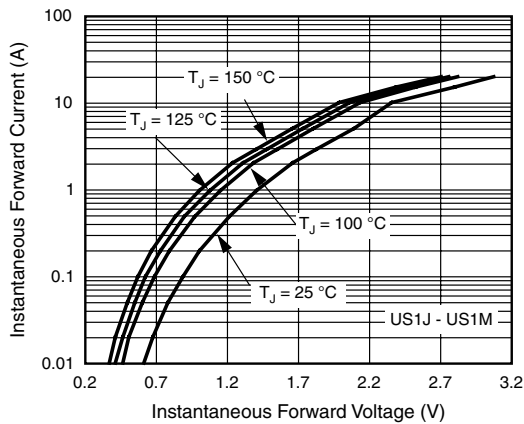

Figure 5. Typical Instantaneous Forward Characteristics

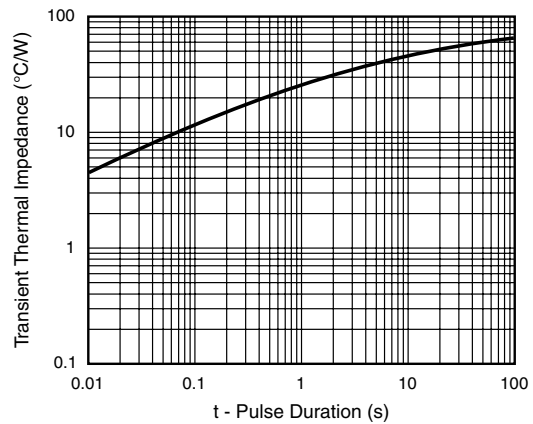
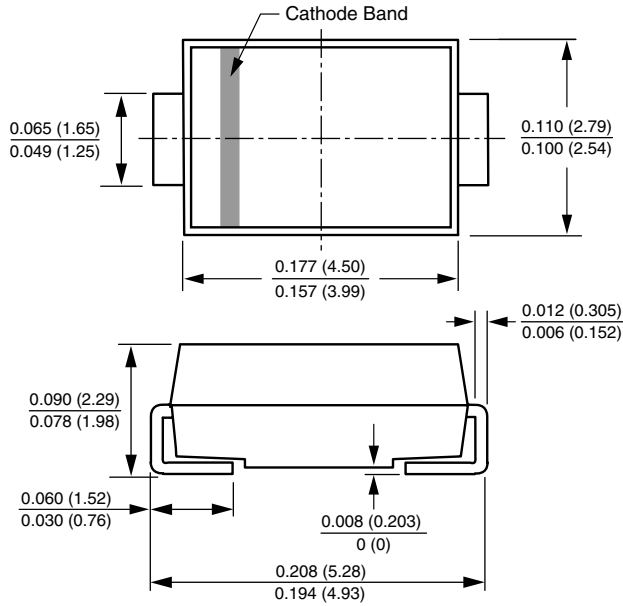

Figure 8. Typical Transient Thermal Impedance

### PACKAGE OUTLINE DIMENSIONS in inches (millimeters)

#### DO-214AC (SMA)



#### Mounting Pad Layout

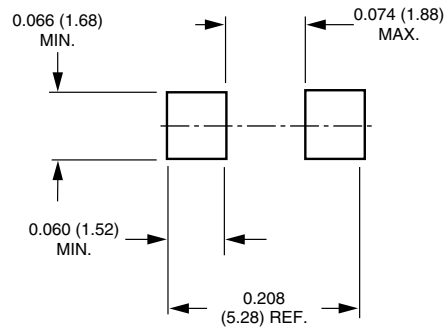



## Disclaimer

All product specifications and data are subject to change without notice.

Vishay Intertechnology, Inc., its affiliates, agents, and employees, and all persons acting on its or their behalf (collectively, "Vishay"), disclaim any and all liability for any errors, inaccuracies or incompleteness contained herein or in any other disclosure relating to any product.

Vishay disclaims any and all liability arising out of the use or application of any product described herein or of any information provided herein to the maximum extent permitted by law. The product specifications do not expand or otherwise modify Vishay's terms and conditions of purchase, including but not limited to the warranty expressed therein, which apply to these products.

No license, express or implied, by estoppel or otherwise, to any intellectual property rights is granted by this document or by any conduct of Vishay.

The products shown herein are not designed for use in medical, life-saving, or life-sustaining applications unless otherwise expressly indicated. Customers using or selling Vishay products not expressly indicated for use in such applications do so entirely at their own risk and agree to fully indemnify Vishay for any damages arising or resulting from such use or sale. Please contact authorized Vishay personnel to obtain written terms and conditions regarding products designed for such applications.

Product names and markings noted herein may be trademarks of their respective owners.