

FEATURES

- For surface mounted applications
- Low profile package
- Built-in strain relief
- Easy pick and place
- Ultrafast recovery times for high efficiency
- Plastic package has Underwriters Laboratory Flammability Classification 94V-0
- Glass passivated junction
- High temperature soldering: 260 °C/10 seconds at terminals

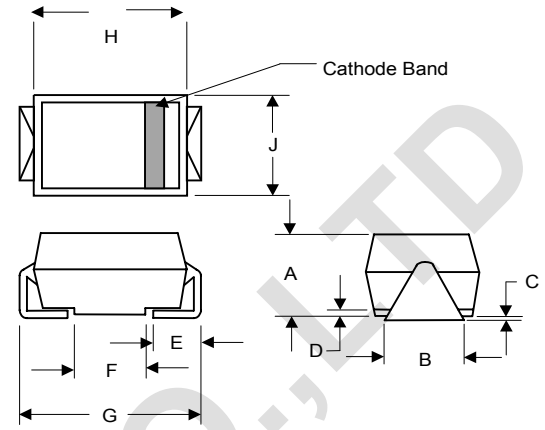

DIM	INCHES		MM		NOTE
	MIN	MAX	MIN	MAX	
A	.078	.116	1.98	2.95	
B	.067	.089	1.70	2.25	
C	.002	.008	.05	.20	
D	--	.02	--	.51	
E	.035	.055	.89	1.40	
F	.065	.096	1.65	2.45	
G	.205	.224	5.21	5.69	
H	.160	.180	4.06	4.57	
J	.100	.112	2.57	2.84	

MECHANICAL DATA

- Case: JEDEC DO-214AC molded plastic
- Terminals: Solder plated, solderable per MIL-STD-750, Method 2026
- Polarity: Indicated by cathode band
- Standard packaging: 12mm tape (EIA-481)
- Weight: 0.002 ounce, 0.064 gram

SUGGESTED SOLDER PAD LAYOUT

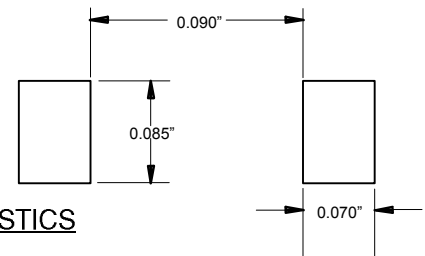

MAXIMUM RATINGS AND ELECTRICAL CHARACTERISTICS

Ratings at 25 °C ambient temperature unless otherwise specified.
Resistive or inductive load. For capacitive load, derate current by 20%.

	SYMBOLS	US1A	US1B	US1D	US1G	US1J	US1K	UNITS
Maximum Recurrent Peak Reverse Voltage	V_{RRM}	50	100	200	400	600	800	Volts
Maximum RMS Voltage	V_{RMS}	35	70	140	280	420	560	Volts
Maximum DC Blocking Voltage	V_{DC}	50	100	200	400	600	800	Volts
Maximum Average Forward Rectified Current, at $T_L=100$ °C	$I_{(AV)}$	1.0						Amps
Peak Forward Surge Current 8.3ms single half sine-wave superimposed on rated load (JEDEC method) $T_A=55$ °C	I_{FSM}	30.0						Amps
Maximum Instantaneous Forward Voltage at 1.0A	V_F	1.0		1.4		1.7		Volts
Maximum DC Reverse Current $T_A=25$ °C At Rated DC Blocking Voltage $T_A=100$ °C	I_R	10.0 100						µgA
Maximum Reverse Recovery Time (Note 1) $T_J=25$ °C	T_{RR}	50.0			100.0			nS
Typical Junction capacitance (Note 2)	C_J	17						pF
Maximum Thermal Resistance (Note 3)	$R_{\theta JK}$	30						°C/W
Operating and Storage Temperature Range	T_J, T_{STG}	-50 to +150						°C

NOTES:

- Reverse Recovery Test Conditions: $I_F=0.5A$, $I_R=1.0A$, $I_{rr}=0.25A$
- Measured at 1 MHz and Applied reverse voltage of 4.0 volts
- 8.0mm² (.013mm thick) land areas

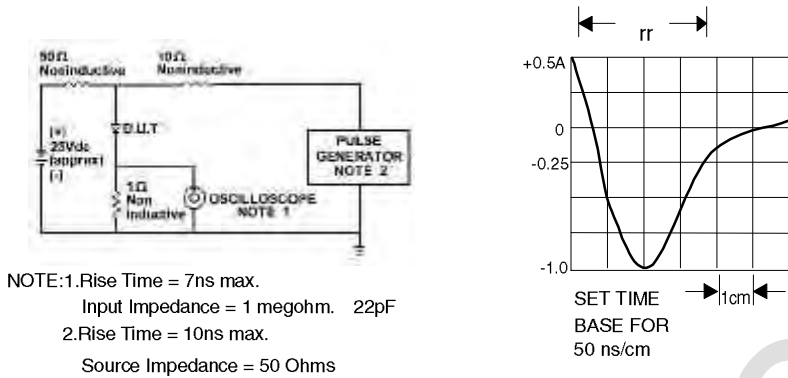

Fig. 1-REVERSE RECOVERY TIME CHARACTERISTIC AND TEST CIRCUIT DIAGRA

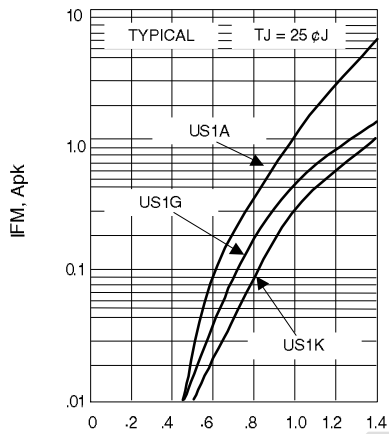

Fig. 2-FORWARD CHARACTERISTICS

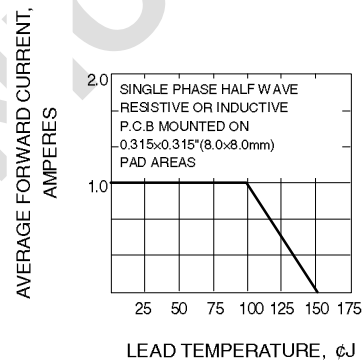

Fig. 3-FORWARD CURRENT DERATING CURVE

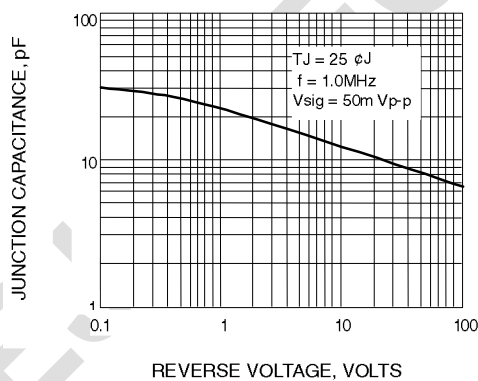

Fig. 4-TYPICAL JUNCTION CAPACITANCE

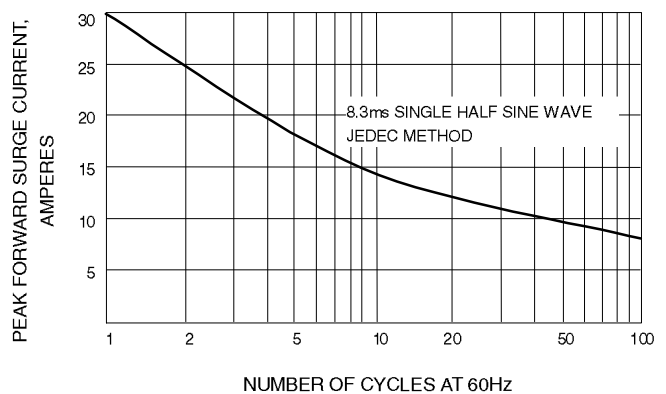

Fig. 5-PEAK FORWARD SURGE CURRENT