

500 WATT MULTI-LINE ULTRA LOW CAPACITANCE TVS ARRAY



DESCRIPTION

The USB508xx and USB508xxC Series are multi-line ultra low capacitance transient voltage suppressor arrays that provide board level protection for computing and telecommunications applications against the damaging effects of ESD, tertiary lightning and switching transients.

The USB508xx and USB508xxC Series has a peak pulse power rating of 500 Watts for an 8/20 μ s waveshape. This device series meets the IEC 61000-4-2 requirements.

FEATURES

- Compatible with IEC 61000-4-2 (ESD): Air - 15kV, Contact - 8kV
- 500 Watts Peak Pulse Power per Line ($t_p = 8/20\mu s$)
- Unidirectional and Bidirectional Configurations
- Available in Multiple Voltages Ranging from 3V to 24V
- Ultra Low Capacitance: 3pF
- RoHS Compliant
- REACH Compliant

APPLICATIONS

- Ethernet - 10/100/1000 Base T
- Computing Interfaces
- xDSL Interfaces
- Cellular Phone Terminals

MECHANICAL CHARACTERISTICS

- Molded JEDEC SO-8 Package
- Approximate Weight: 70 milligrams
- Lead-Free Pure-Tin Plating (Annealed)
- Solder Reflow Temperature:
Pure-Tin - Sn, 100: 260-270°C
- 12mm Tape and Reel Per EIA Standard 481
- Flammability Rating UL 94V-0

PIN CONFIGURATIONS

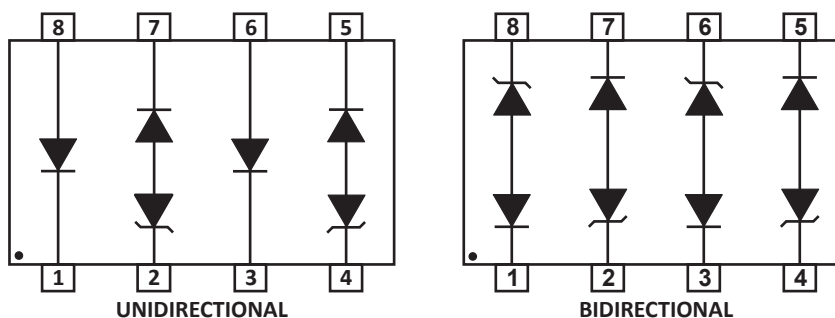

TYPICAL DEVICE CHARACTERISTICS
MAXIMUM RATINGS @ 25°C Unless Otherwise Specified

PARAMETER	SYMBOL	VALUE	UNITS
Operating Temperature	T_L	-55 to 150	°C
Storage Temperature	T_{STG}	-55 to 150	°C
Peak Pulse Power (tp = 8/20µs) - See Figure 1	P_{PP}	500	Watts

ELECTRICAL CHARACTERISTICS PER LINE @ 25°C Unless Otherwise Specified

PART NUMBER (Note 1-5)	DEVICE MARKING	RATED STAND-OFF VOLTAGE	MINIMUM BREAKDOWN VOLTAGE	MAXIMUM CLAMPING VOLTAGE (Fig. 2)	MAXIMUM CLAMPING VOLTAGE (Fig. 2)	MAXIMUM LEAKAGE CURRENT	MAXIMUM CAPACITANCE
		V_{WM} VOLTS	@1mA $V_{(BR)}$ VOLTS	@ $I_p = 1A$ V_C VOLTS	@ $I_p = 5A$ V_C VOLTS	@ V_{WM} I_D µA	@0V, 1MHz C pF
USB50803	GA	3.3	4.5	8.0	11.0	125	3
USB50803C	UGA	3.3	4.5	8.0	11.0	125	3
USB50805	GB	5.0	6.0	10.8	13.0	20	3
USB50805C	UGB	5.0	6.0	10.8	13.0	20	3
USB50812	GC	12.0	13.3	19.0	26.0	1	3
USB50812C	UGC	12.0	13.3	19.0	26.0	1	3
USB50815	GD	15.0	16.7	24.0	32.0	1	3
USB50815C	UGD	15.0	16.7	24.0	32.0	1	3
USB50824	GE	24.0	26.7	43.0	57.0	1	3
USB50824C	UGE	24.0	26.7	43.0	57.0	1	3

NOTES

1. Part numbers with a "C" suffix are bidirectional devices, i.e., USB50803C.
2. Do not apply surge in the forward direction of the TVS.
3. PIV typically greater than 100V for each rectifier diode.
4. Electrical characteristics apply to pins 8 to 1, 2 to 7, 6 to 3 and 4 to 5 for the bidirectional configuration.
5. Electrical characteristics apply to pins 7 to 2 and 5 to 4 for the unidirectional configuration.

TYPICAL DEVICE CHARACTERISTICS

FIGURE 1
PEAK PULSE POWER VS PULSE TIME

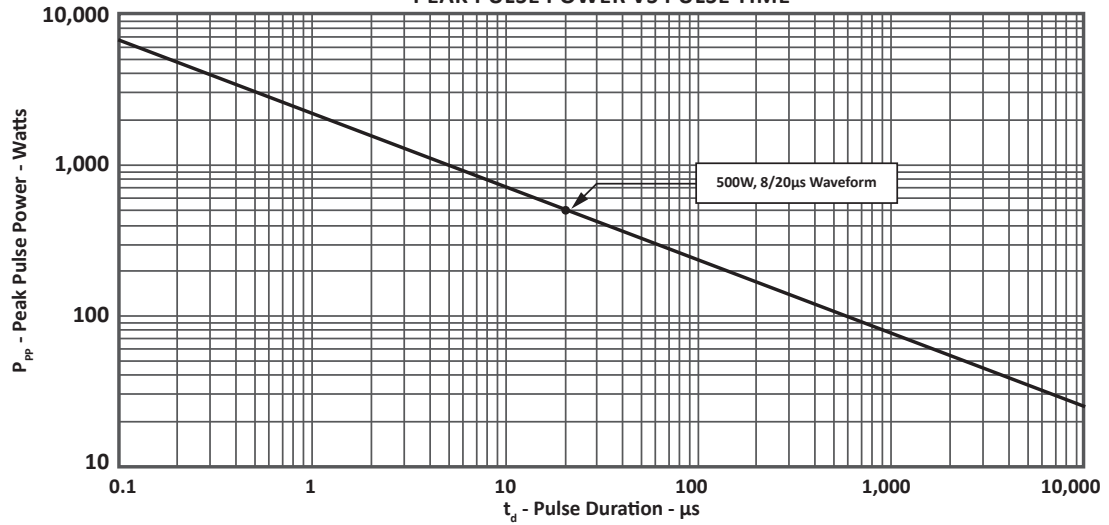

FIGURE 2
PULSE WAVE FORM

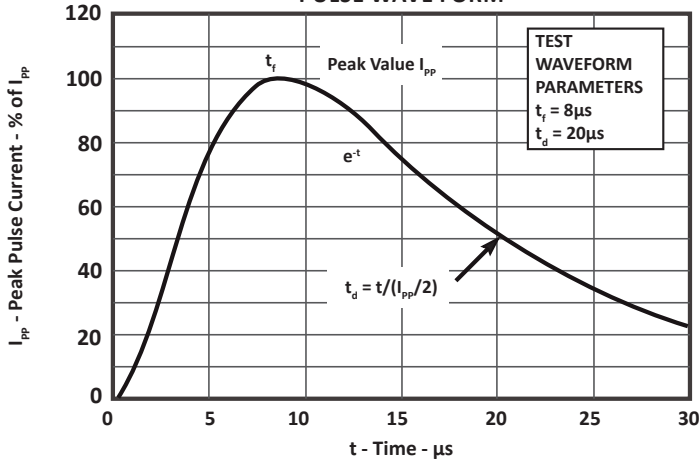
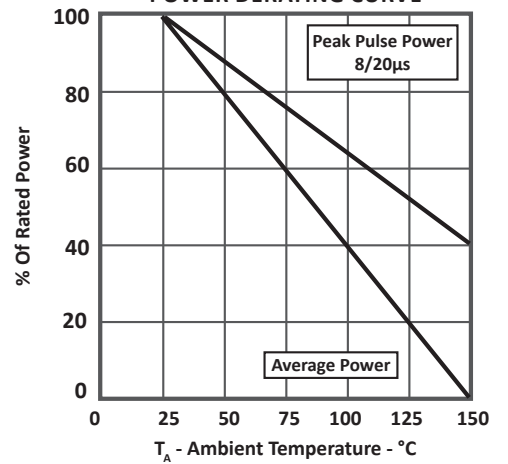

FIGURE 3
POWER DERATING CURVE



SO-8 PACKAGE INFORMATION

OUTLINE DIMENSIONS

DIM	MILLIMETERS		INCHES	
	MIN	MAX	MIN	MAX
A	4.80	5.00	0.189	0.196
B	3.80	4.00	0.150	0.157
C	1.35	1.75	0.054	0.068
D	0.35	0.49	0.014	0.019
F	0.40	1.25	0.016	0.049
G	1.27 BSC		0.05 BSC	
J	0.18	0.25	0.007	0.009
K	0.10	0.25	0.004	0.008
P	5.80	6.20	0.229	0.244
R	0.25	0.50	0.010	0.019

NOTES

- T = Seating plane and datum surface.
- Dimensions "A" and "B" are datum.
- Dimensions "A" and "B" do not include mold protrusion.
- Maximum mold protrusion is 0.015" (0.380mm) per side.
- Dimensioning and tolerances per ANSI Y14.5M, 1982.
- Dimensions are exclusive of mold flash and metal burrs.

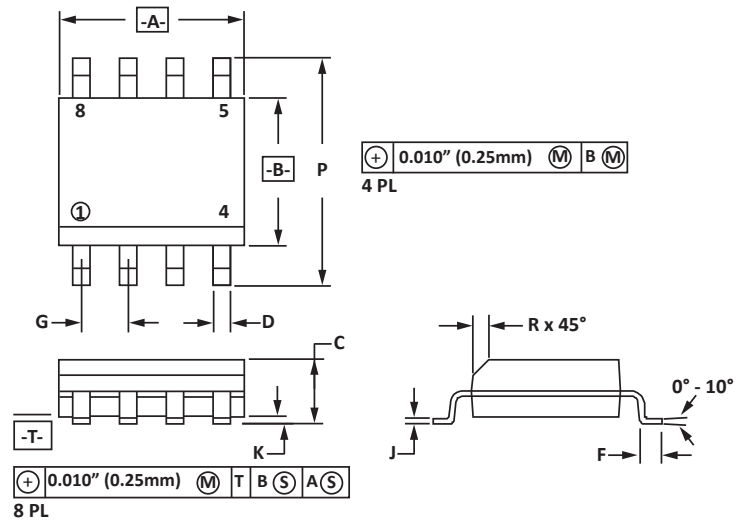

PAD LAYOUT DIMENSIONS

DIM	MILLIMETERS		INCHES	
	MIN	MAX	MIN	MAX
A	1.14	1.40	0.045	0.055
B	0.64	0.89	0.025	0.035
C	6.22	-	0.245	-
D	3.94	4.17	0.155	0.165
E	1.02	1.27	0.040	0.050

NOTES

- Controlling dimension: inches.

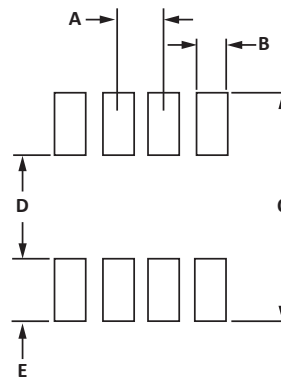

TAPE AND REEL

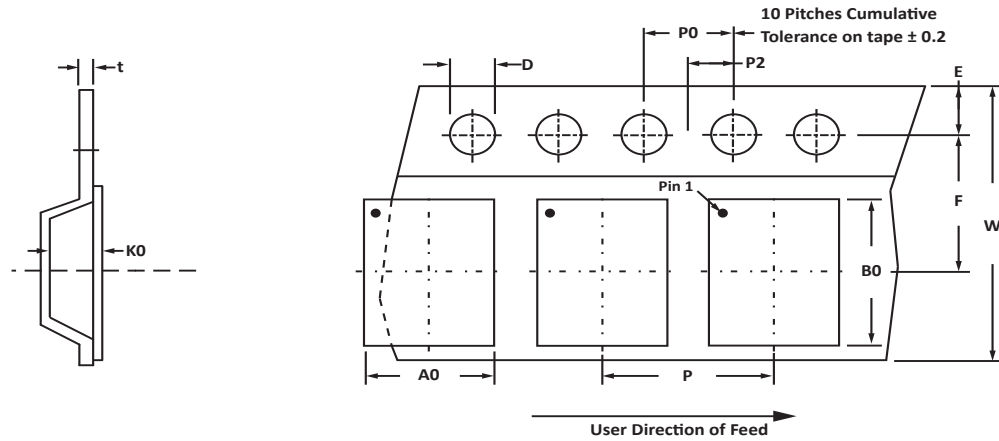

SPECIFICATIONS

REEL DIA.	TAPE WIDTH	A0	B0	K0	D	E	F	W	P0	P2	P	t _{max}
178mm (7")	12mm	6.50 ± 0.10	5.40 ± 0.10	2.00 ± 0.10	1.50 ± 0.10	1.75 ± 0.10	5.50 ± 0.05	12.00 ± 0.30	4.00 ± 0.12	2.00 ± 0.10	4.00 ± 0.10	0.25

NOTES

1. Dimensions are in millimeters.
2. Surface mount product is taped and reeled in accordance with EIA-481.
3. Suffix - T7 = 7" Reel - 1,000 pieces per 12mm tape.
4. Suffix - T13 = 13" Reel - 2,500 pieces per 12mm tape.
5. Bulk product shipped in tubes of 98 pieces per tube.
6. Marking on Part - marking code (see page 2), date code, logo and pin one defined by dot on top of package.

Package outline, pad layout and tape specifications per document number 06011.R4 8/10.

ORDERING INFORMATION

BASE PART NUMBER (xx = Voltage)	LEADFREE SUFFIX	TAPE SUFFIX	QTY/REEL	REEL SIZE	TUBE QTY
USB0508xx/USB0508xxC	n/a	-T7	1,000	7"	98
USB0508xx/USB0508xxC	n/a	-T13	2,500	13"	98

COMPANY INFORMATION

COMPANY PROFILE

ProTek Devices, based in Tempe, Arizona USA, is a manufacturer of Transient Voltage Suppression (TVS) products designed specifically for the protection of electronic systems from the effects of lightning, Electrostatic Discharge (ESD), Nuclear Electromagnetic Pulse (NEMP), inductive switching and EMI/RFI. With over 25 years of engineering and manufacturing experience, ProTek designs TVS devices that provide application specific protection solutions for all electronic equipment/systems.

ProTek Devices Analog Products Division, also manufactures analog interface, control, RF and power management products.

CONTACT US

Corporate Headquarters

2929 South Fair Lane
Tempe, Arizona 85282
USA

By Telephone

General: 602-431-8101
Sales: 602-414-5109
Customer Service: 602-414-5114

By Fax

General: 602-431-2288

By E-mail:

Sales: sales@protekdevices.com
Customer Service: service@protekdevices.com
Technical Support: support@protekdevices.com

Web

www.protekdevices.com
www.protekanalog.com

COPYRIGHT © ProTek Devices 2009 - This literature is subject to all applicable copyright laws and is not for resale in any manner.

SPECIFICATIONS: ProTek reserves the right to change the electrical and or mechanical characteristics described herein without notice.

DESIGN CHANGES: ProTek reserves the right to discontinue product lines without notice and that the final judgement concerning selection and specifications is the buyer's and that in furnishing engineering and technical assistance. ProTek assumes no responsibility with respect to the selection or specifications of such products. ProTek makes no warranty, representation or guarantee regarding the suitability of its products for any particular purpose, nor does ProTek assume any liability arising out of the application or use of any product or circuit and specifically disclaims any and all liability without limitation special, consequential or incidental damages.

LIFE SUPPORT POLICY: ProTek Devices products are not authorized for use in life support systems without written consent from the factory.