



# UT136FF/FG

**TRIAC**

## TRIAC

■ DESCRIPTION

Glass passivated triac in a full pack plastic envelope, intended for use in applications requiring high bidirectional transient and blocking voltage capability and high thermal cycling performance. Typical applications include motor control, industrial and domestic lighting, heating and static switching.

■ SYMBOL

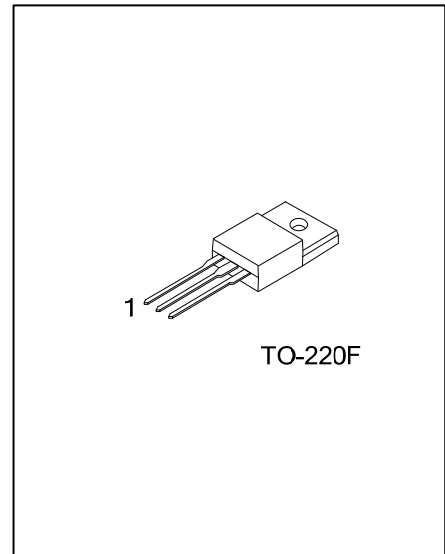
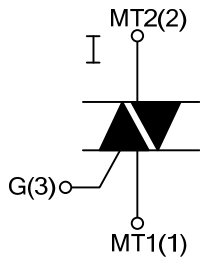

■ ORDERING INFORMATION

Ordering Number		Package	Pin Description			Packing
Lead Free	Halogen Free		1	2	3	
UT136FFL-5-TF3-R	UT136FFP-5-TF3-R	TO-220F	MT1	MT2	G	Tube
UT136FFL-6-TF3-R	UT136FFP-6-TF3-R	TO-220F	MT1	MT2	G	Tube
UT136FFL-8-TF3-R	UT136FFP-8-TF3-R	TO-220F	MT1	MT2	G	Tube
UT136FGL-5-TF3-R	UT136FGP-5-TF3-R	TO-220F	MT1	MT2	G	Tube
UT136FGL-6-TF3-R	UT136FGP-6-TF3-R	TO-220F	MT1	MT2	G	Tube
UT136FGL-8-TF3-R	UT136FGP-8-TF3-R	TO-220F	MT1	MT2	G	Tube

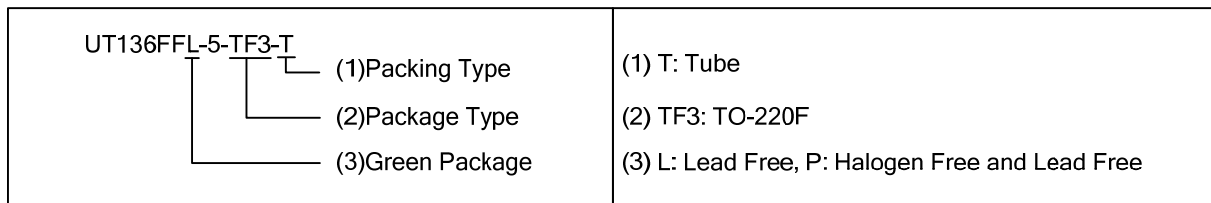

■ MARKING

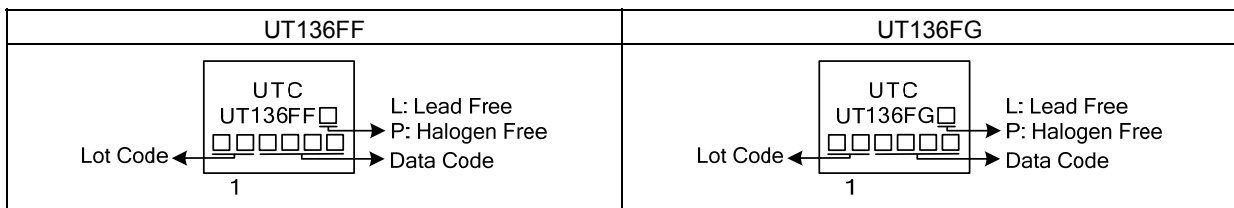

## ■ ABSOLUTE MAXIMUM RATING

PARAMETER		SYMBOL	RATINGS	UNIT
Repetitive Peak Off-State Voltages	UT136FF/FG-5	$V_{DRM}$	500(Note2)	V
	UT136FF/FG-6		600(Note2)	
	UT136FF/FG-8		800	
RMS On-state Current Full sine wave, $T_{HS} \leq 92^{\circ}C$		$I_{T(RMS)}$	4	A
Non-Repetitive Peak. On-State Current Full sine wave, $T_J = 125^{\circ}C$ prior to surge, with reapplied $V_{DRM(MAX)}$	$t = 20$ ms	$I_{TSM}$	25	A
	$t = 16.7$ ms		27	
$I^2t$ For Fusing ( $t = 10$ ms)		$I^2t$	3.1	$A^2s$
Repetitive Rate of Rise of On-state Current after Triggering $I_{TM} = 6$ A, $I_G = 0.2$ A, $dI_G/dt = 0.2A/\mu s$	T2 + G+	$di_T/dt$	50	A/ $\mu s$
	T2 + G-		50	
	T2 - G-		50	
	T2 - G+		10	
Peak Gate Voltage		$V_{GM}$	5	V
Peak Gate Current		$I_{GM}$	2	A
Peak Gate Power		$P_{GM}$	5	W
Average Gate Power (Over any 20ms period)		$P_{G(AV)}$	0.5	W
Operating Junction Temperature		$T_J$	125	$^{\circ}C$
Storage Temperature		$T_{STG}$	-40 ~ +150	$^{\circ}C$

Notes: 1. Absolute maximum ratings are those values beyond which the device could be permanently damaged.

Absolute maximum ratings are stress ratings only and functional device operation is not implied.

2. Although not recommended, off-state voltages up to 800V may be applied without damage, but the triac may switch to the on-state. The rate of rise of current should not exceed 3A/ $\mu s$ .

## ■ THERMAL DATA

PARAMETER	SYMBOL	MIN	TYP	MAX	UNIT
Thermal Resistance, Junction to Ambient (In free air)	$\theta_{JA}$		55		K/W

## ■ ISOLATION LIMITING VALUE & CHARACTERISTIC ( $T_{HS} = 25^{\circ}C$ , unless otherwise specified)

PARAMETER	SYMBOL	MIN	TYP	MAX	UNIT
Repetitive peak voltage from all three terminals to external heatsink (R.H. $\leq 65\%$ , clean and dustfree)	$V_{ISOL}$			1500	V
Capacitance from MT2 to external heatsink ( $f = 1$ MHz)	$C_{ISOL}$		12		pF

## ■ STATIC CHARACTERISTICS ( $T_J = 25^{\circ}C$ , unless otherwise specified)

PARAMETER	SYMBOL	TEST CONDITIONS	MIN	TYP	MAX		UNIT
					UT136FF	UT136FG	
Gate Trigger Current	$I_{GT}$	$V_D = 12$ V, $I_T = 0.1$ A	T2 + G+	5	25	50	mA
			T2 + G-	8	25	50	mA
			T2 - G-	11	25	50	mA
			T2 - G+	30	70	100	mA
Latching Current	$I_L$	$V_D = 12$ V, $I_{GT} = 0.1$ A	T2 + G+	7	20	30	mA
			T2 + G-	16	30	45	mA
			T2 - G-	5	20	30	mA
			T2 - G+	7	30	45	mA
Holding Current	$I_H$	$V_D = 12$ V, $I_{GT} = 0.1$ A		5	15	30	mA
On-State Voltage	$V_T$	$I_T = 5$ A		1.4	1.70		V
Gate Trigger Voltage	$V_{GT}$	$V_D = 12$ V, $I_T = 0.1$ A		0.7	1.5		V
		$V_D = 400$ V, $I_T = 0.1$ A, $T_J = 125^{\circ}C$	0.25	0.4			V
Off-State Leakage Current	$I_D$	$V_D = V_{DRM(MAX)}$ , $T_J = 125^{\circ}C$		0.1	0.5		mA

■ DYNAMIC CHARACTERISTICS (T<sub>J</sub>=25°C, unless otherwise specified)

PARAMETER	SYMBOL	TEST CONDITIONS	MIN		TYP	MAX	UNIT
			UT136FF	UT136FG			
Critical Rate of Rise of Off-State Voltage	dV <sub>D</sub> /dt	V <sub>DM</sub> = 67% V <sub>DRM(MAX)</sub> , T <sub>J</sub> =125°C, exponential waveform, gate open circuit	50	200	250		V/μs
Critical Rate of Change of Commutating Voltage	dV <sub>COM</sub> /dt	V <sub>DM</sub> =400V, T <sub>J</sub> =95°C, I <sub>T(RMS)</sub> =4A, dI <sub>COM</sub> /dt=1.8A/ms, gate open circuit		10	50		V/μs
Gate Controlled Turn-On Time	t <sub>GT</sub>	I <sub>TM</sub> =6A, V <sub>D</sub> = V <sub>DRM(MAX)</sub> , I <sub>G</sub> =0.1A, dI <sub>G</sub> /dt=5A/μs			2		μs

## TYPICAL CHARACTERISTICS

Maximum On-State Dissipation,  $P_{TOT}$  vs RMS On-State Current,  $I_{T(RMS)}$ , Where  $\alpha$ =Conduction Angle

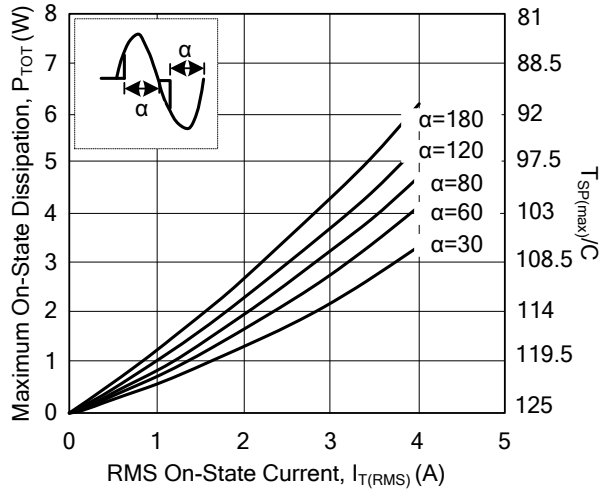

Maximum Permissible Non-Repetitive Peak On-State Current,  $I_{TSM}$ , vs Pulse Width  $t_p$ , for Sinusoidal Current,  $t_p \leq 20ms$

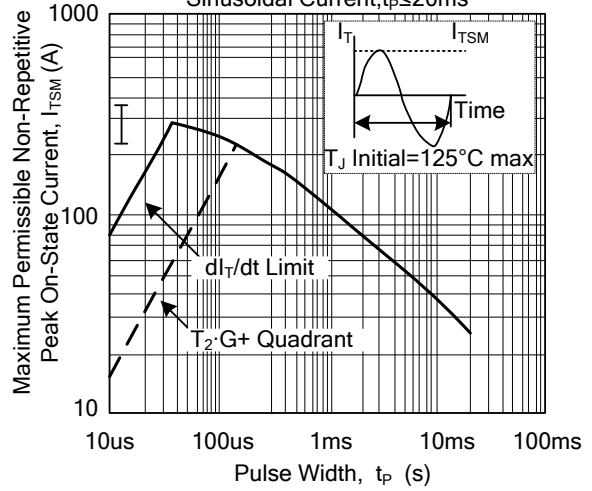

Maximum Permissible Non-Repetitive Peak On-State Current,  $I_{TSM}$ , vs Number of Cycles, for Sinusoidal Current,  $f=50Hz$

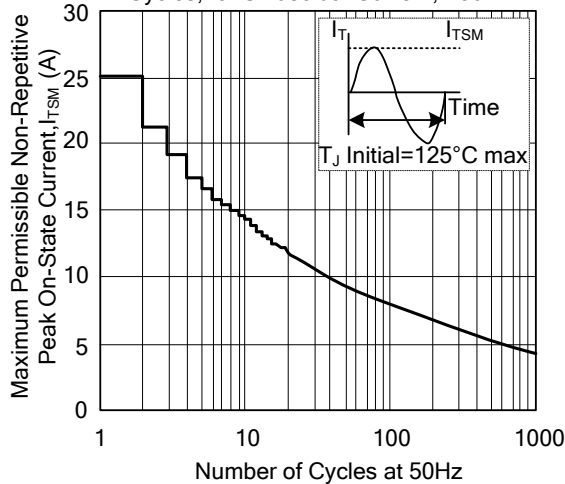

Maximum Permissible RMS Current  $I_{T(RMS)}$  vs Heatsink Temperature  $T_{HS}$

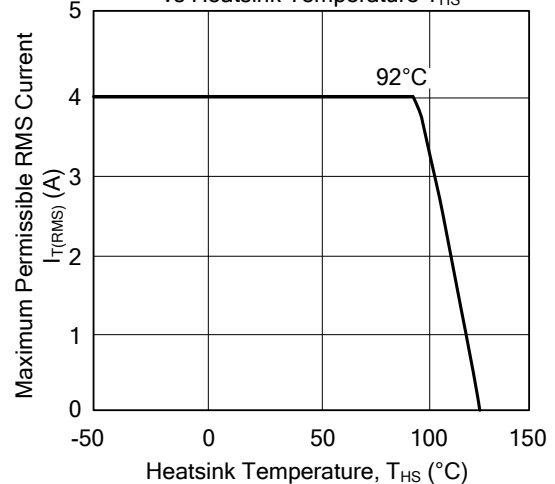

Maximum Permissible Repetitive RMS On-State Current,  $I_{T(RMS)}$ , vs Surge Duration, for Sinusoidal Current,  $f=50Hz, T_{HS} \leq 92^\circ C$

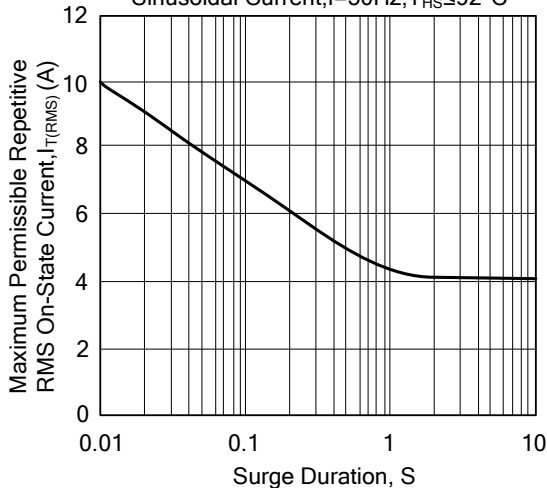

Normalised Gate Trigger Voltage  $V_{GT}(T_J)/V_{GT}(25^\circ C)$ , vs Junction Temperature  $T_J$

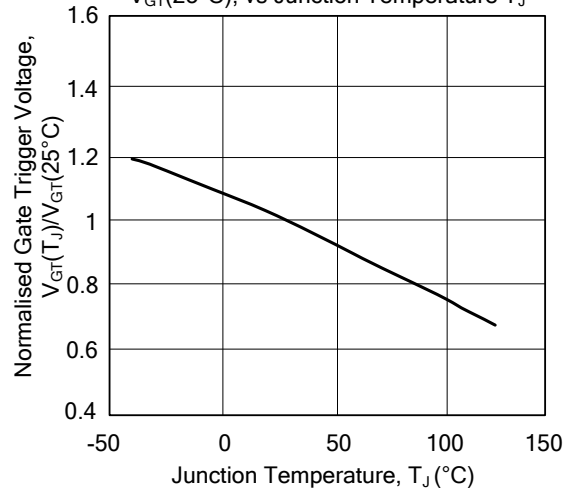

## TYPICAL CHARACTERISTICS(Cont.)

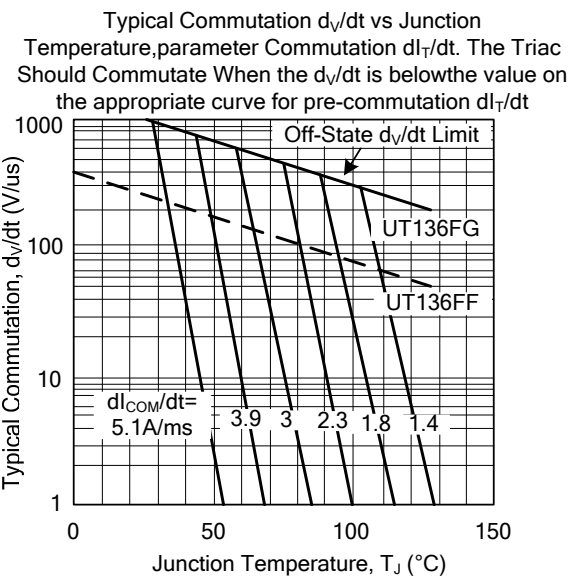
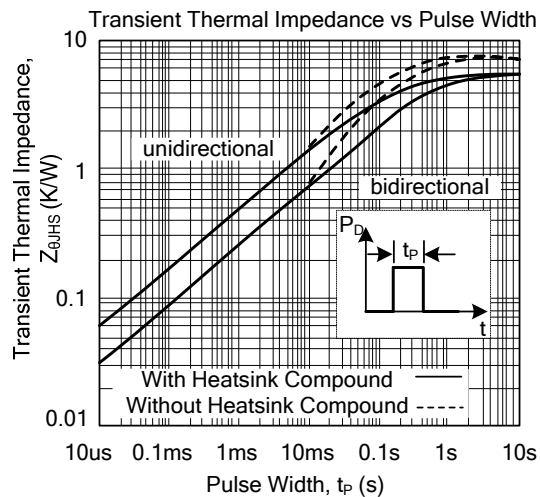
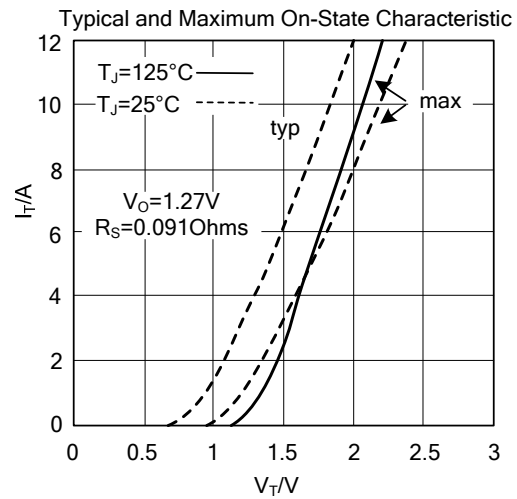
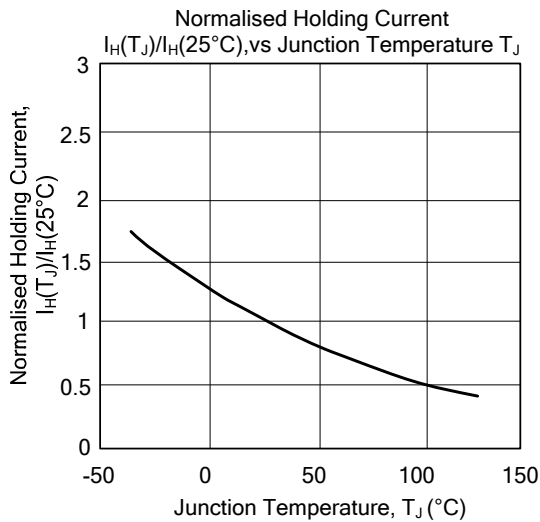
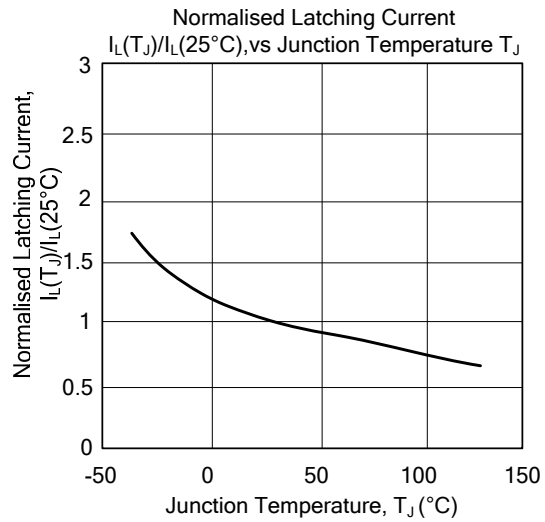
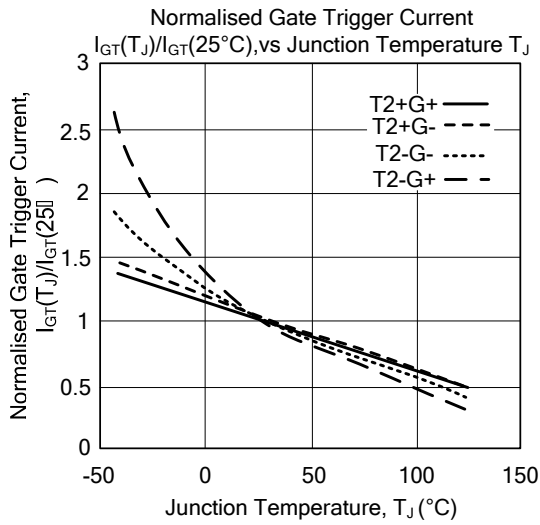

UTC assumes no responsibility for equipment failures that result from using products at values that exceed, even momentarily, rated values (such as maximum ratings, operating condition ranges, or other parameters) listed in products specifications of any and all UTC products described or contained herein. UTC products are not designed for use in life support appliances, devices or systems where malfunction of these products can be reasonably expected to result in personal injury. Reproduction in whole or in part is prohibited without the prior written consent of the copyright owner. The information presented in this document does not form part of any quotation or contract, is believed to be accurate and reliable and may be changed without notice.