



# UT137E

TRIAC

## TRIAC

### DESCRIPTION

Passivated, sensitive gate triacs in a plastic envelope, intended for use in general purpose bidirectional switching and phase control applications, where high sensitivity is required in all four quadrants.

### SYMBOL

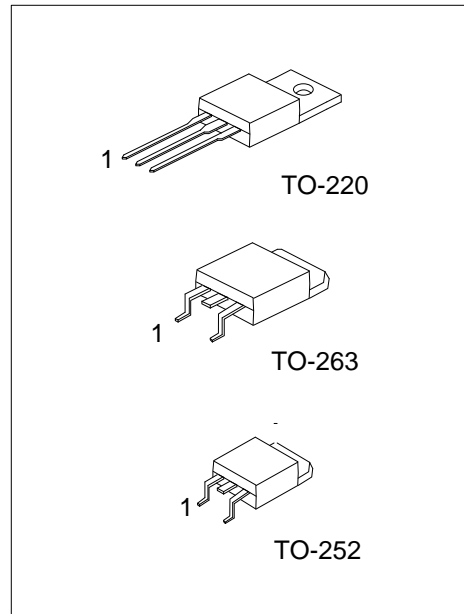
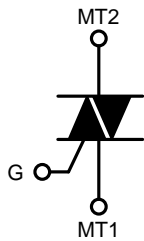

### ORDERING INFORMATION

Order Number		Package	Pin Assignment			Packing
Lead Free	Halogen Free		1	2	3	
UT137EL-x-TA3-T	UT137EG-x-TA3-T	TO-220	MT1	MT2	GATE	Tube
UT137EL-x-TN3-R	UT137EG-x-TN3-R	TO-252	MT1	MT2	GATE	Tape Reel
UT137EL-x-TQ2-T	UT137EG-x-TQ2-T	TO-263	MT1	MT2	GATE	Tube
UT137EL-x-TQ2-R	UT137EG-x-TQ2-R	TO-263	MT1	MT2	GATE	Tape Reel

<p>UT137EG-x-TA3-T</p> <p>(1)Packing Type</p> <p>(2)Package Type</p> <p>(3)Peak Voltage</p> <p>(4)Green Package</p>	<p>(1) T: Tube, R: Tape Reel</p> <p>(2) TA3: TO-220, TN3: TO-252, TQ2: TO-263</p> <p>(3) 5: 500V, 6: 600V, 8: 800V</p> <p>(4) G: Halogen Free and Lead Free, L: Lead Free</p>
---	---

### MARKING

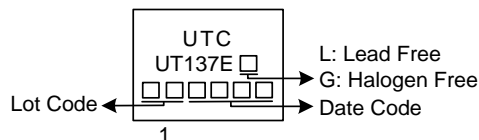

## ■ ABSOLUTE MAXIMUM RATING

PARAMETER		SYMBOL	RATINGS	UNIT
Repetitive peak off-state voltages	UT137E-5	$V_{DRM}$	500 (Note 2)	V
	UT137E-6		600 (Note 2)	V
	UT137E-8		800	V
RMS on-state current full sine wave; $T_{mb} \leq 102^{\circ}C$		$I_{T(RMS)}$	8	A
Non-repetitive peak on-state current (Full sine wave; $T_J = 25^{\circ}C$ prior to surge)	$t = 20ms$	$I_{TSM}$	65	A
	$t = 16.7 ms$		71	
$I^2t$ for fusing	$t = 10 ms$	$I^2t$	21	$A^2s$
Repetitive rate of rise of on-state current after triggering $I_{TM}=12A$ ; $I_G=0.2A$ ; $dI_G/dt=0.2A/\mu s$	T2+ G+	$di_T/dt$	50	$A/\mu s$
	T2+ G-		50	$A/\mu s$
	T2- G-		50	$A/\mu s$
	T2- G+		10	$A/\mu s$
Peak gate voltage		$V_{GM}$	5	V
Peak gate current		$I_{GM}$	2	A
Peak gate power		$P_{GM}$	5	W
Average gate power (over any 20 ms period)		$P_{G(AV)}$	0.5	W
Junction Temperature		$T_J$	125	$^{\circ}C$
Storage Temperature		$T_{STG}$	-40 ~ +150	$^{\circ}C$

Note: 1. Absolute maximum ratings are those values beyond which the device could be permanently damaged. Absolute maximum ratings are stress ratings only and functional device operation is not implied.

2. Although not recommended, off-state voltages up to 800V may be applied without damage, but the triac may switch to the on-state. The rate of rise of current should not exceed  $6A/\mu s$ .

## ■ THERMAL DATA

PARAMETER			SYMBOL	MIN	TYP	MAX	UNIT	
Thermal resistance Junction to Ambient	In Free Air	TO-220	$\theta_{JA}$		60		$^{\circ}C/W$	
		TO-263						
		TO-252						
Thermal resistance Junction to mounting base	Full cycle	TO-220	$\theta_{JC}$			2.0	$^{\circ}C/W$	
		TO-263						
		TO-252						
	Half cycle	TO-220					2.4	$^{\circ}C/W$
		TO-263						
		TO-252						

## ■ STATIC CHARACTERISTICS ( $T_J=25^{\circ}C$ , unless otherwise stated)

PARAMETER	SYMBOL	TEST CONDITIONS	MIN	TYP	MAX	UNIT
Gate trigger current	$I_{GT}$	$V_D = 12 V$ ; $I_T = 0.1 A$	T2+G+	2.5	10	mA
			T2+G-	4.0	10	mA
			T2-G-	5.0	10	mA
			T2-G+	11	25	mA
Latching current	$I_L$	$V_D = 12 V$ ; $I_{GT} = 0.1 A$	T2+G+	3.0	25	mA
			T2+G-	14	35	mA
			T2-G-	3.0	25	mA
			T2-G+	4.0	35	mA
Holding current	$I_H$	$V_D = 12 V$ ; $I_{GT} = 0.1 A$		2.5	20	mA
On-state voltage	$V_T$	$I_T = 10 A$		1.3	1.65	V
Gate trigger voltage	$V_{GT}$	$V_D = 12 V$ ; $I_T = 0.1 A$		0.7	1.5	V
		$V_D = 400V$ ; $I_T = 0.1 A$ ; $T_J = 125^{\circ}C$	0.25	0.4		V
Off-state leakage current	$I_D$	$V_D = V_{DRM(max)}$ ; $T_J = 125^{\circ}C$		0.1	0.5	mA

■ DYNAMIC CHARACTERISTICS (T<sub>J</sub>=25°C, unless otherwise stated)

parameter	symbol	conditions	min	typ	max	unit
Critical rate of rise of Off-state voltage	d <sub>VD</sub> /dt	V <sub>DM</sub> = 67% V <sub>DRMMAX</sub> ; T <sub>J</sub> =125°C; Exponential waveform; gate open circuit		50		V/μs
Gate controlled turn-on time	t <sub>GT</sub>	I <sub>TM</sub> = 12A; V <sub>D</sub> = V <sub>DRMMAX</sub> ; I <sub>G</sub> =0.1A; d <sub>IG</sub> /dt=5A/μs		2		μs

■ TYPICAL CHARACTERISTICS

Figure 1. Maximum On -State Dissipation.  $P_{tot}$  vs RMS On-State Current,  $I_{T(RMS)}$ , Where  $\alpha$ =conduction Angle

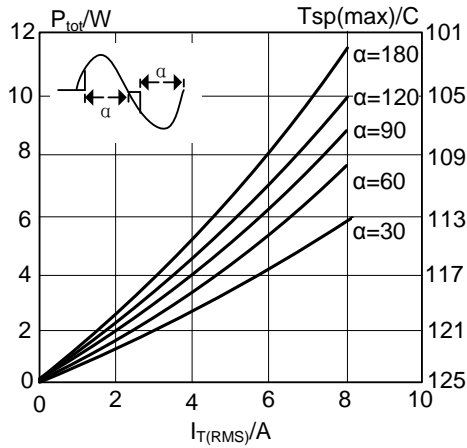

Figure 2. Maximum Permissible Non-Repetitive Peak On-State Current  $I_{TSM}$ , vs Pulse Width  $t_p$ , for Sinusoidal Currents,  $t_p \leq 20ms$

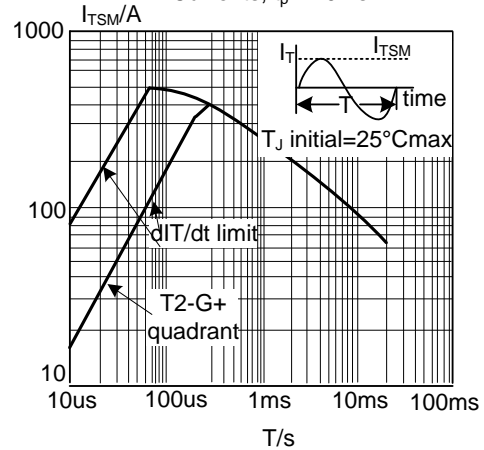

Figure 3. Maximum Permissible Non-Repetitive Peak On-State Current  $I_{TSM}$ , vs Number of Cycles, for Sinusoidal Currents,  $f=50Hz$

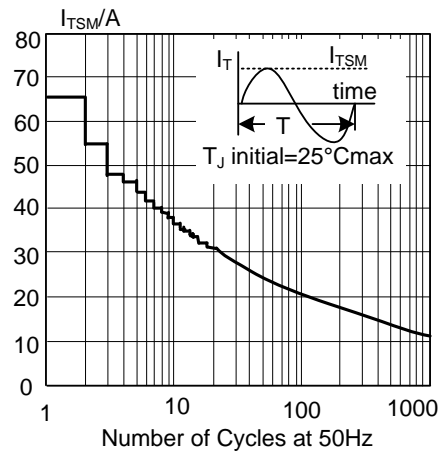

Figure 4. Maximum Permissible RMS Current  $I_{T(RMS)}$  vs Mounting Base Temperature  $T_{mb}$

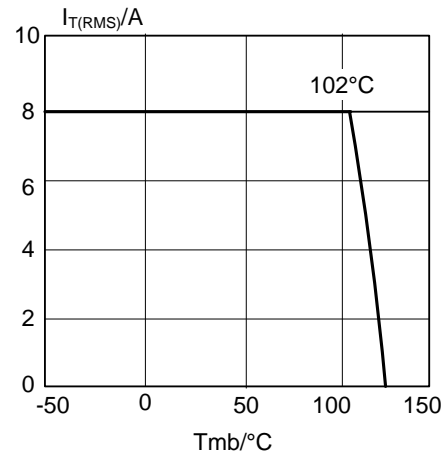

Figure 5. Maximum Permissible Repetitive RMS On-State Current  $I_{T(RMS)}$ , vs Surge Duration, for Sinusoidal Currents,  $f=50Hz$ ,  $T_{mb} \leq 102^\circ C$

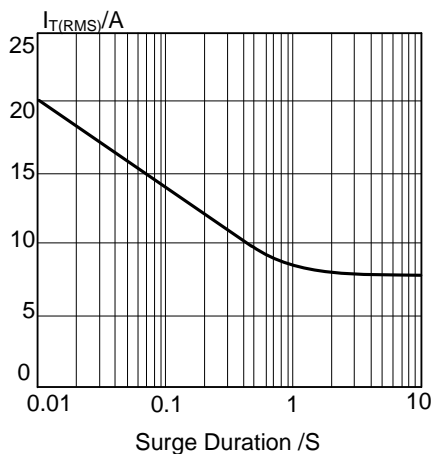
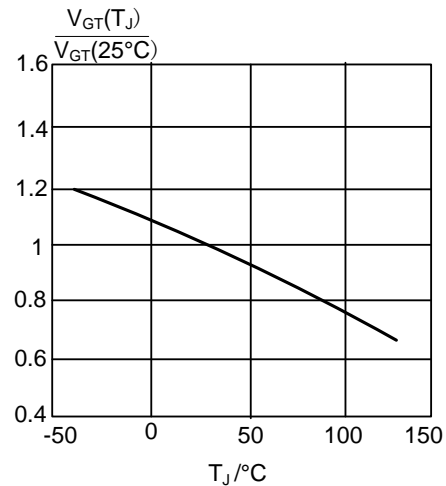

Figure 6. Normalised Gate Trigger Voltage  $V_{GT}(T_J)/V_{GT}(25^\circ C)$ , vs Junction Temperature  $T_J$



■ TYPICAL CHARACTERISTICS(Cont.)

Figure 7. Normalised Gate Trigger Current  $I_{GT}(T_J)/I_{GT}(25^\circ\text{C})$ , vs Junction Temperature  $T_J$

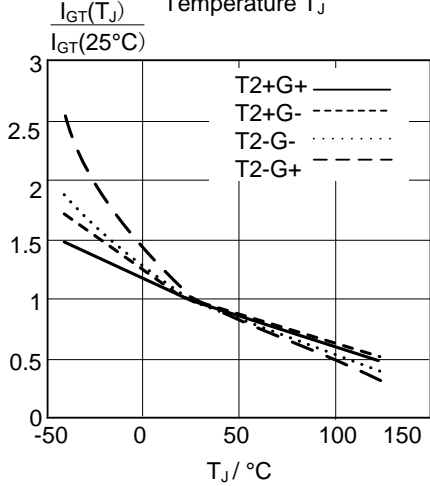

Figure 8. Normalised Latching Current  $I_L(T_J)/I_L(25^\circ\text{C})$ , vs Junction Temperature  $T_J$

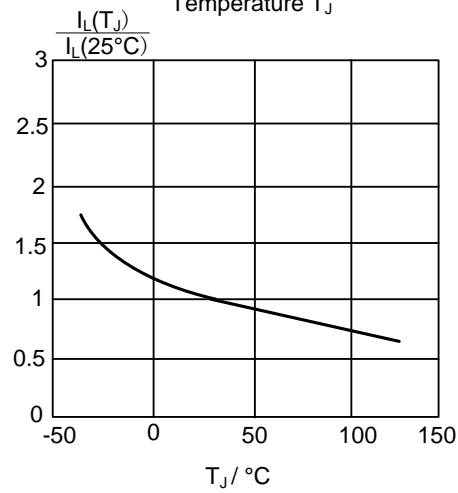

Figure 9. Normalised Holding Current  $I_H(T_J)/I_H(25^\circ\text{C})$ , vs Junction Temperature  $T_J$

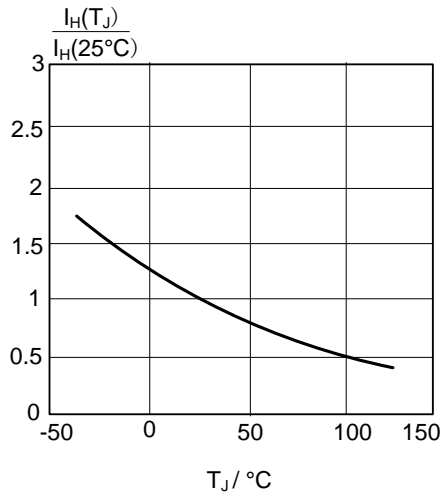

Figure 10. Typical and Maximum On-state Characteristic

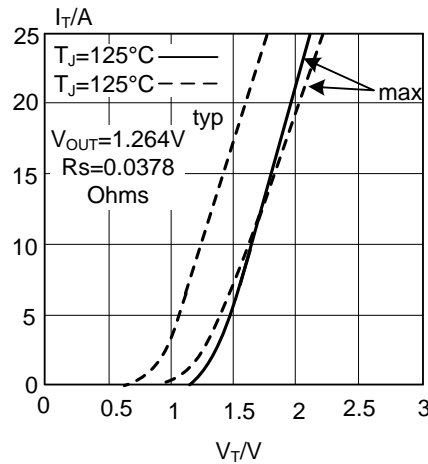

Figure 11. Transient Thermal Impedance  $Z_{th\ j-mb}$ , vs Pulse Width  $t_p$

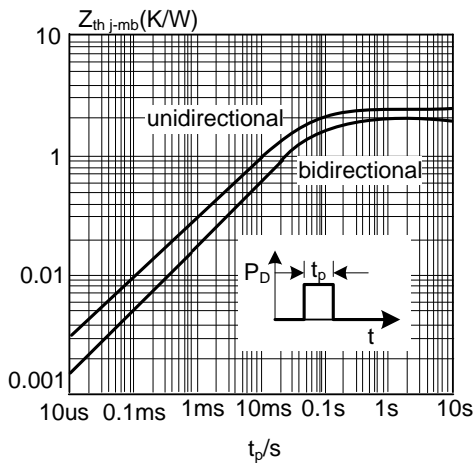
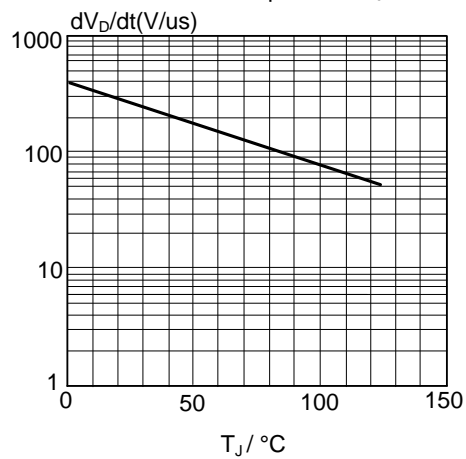

Figure 12. Typical Critical Rate of Rise of Off-State Voltage,  $dV_D/dt$  Versus Junction temperature  $T_J$



UTC assumes no responsibility for equipment failures that result from using products at values that exceed, even momentarily, rated values (such as maximum ratings, operating condition ranges, or other parameters) listed in products specifications of any and all UTC products described or contained herein. UTC products are not designed for use in life support appliances, devices or systems where malfunction of these products can be reasonably expected to result in personal injury. Reproduction in whole or in part is prohibited without the prior written consent of the copyright owner. UTC reserves the right to make changes to information published in this document, including without limitation specifications and product descriptions, at any time and without notice. This document supersedes and replaces all information supplied prior to the publication hereof.