



UT137F/G

TRIAC

TRIAC

■ DESCRIPTION

Passivated triacs in a plastic envelope, intended for use in applications requiring high bidirectional transient and blocking voltage capability and high thermal cycling performance.

Typical applications include motor control, industrial and domestic lighting, heating and static switching.

■ SYMBOL

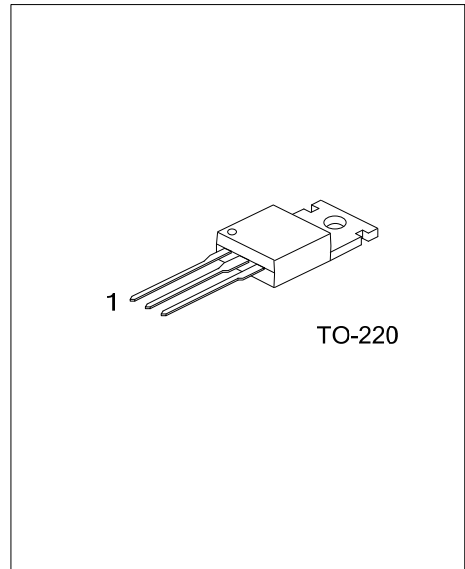
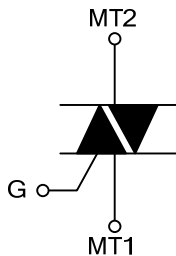

■ ORDERING INFORMATION

Order Number		Package	Pin Assignment			Packing
Normal	Lead Free Plating		1	2	3	
UT137FL-x-TA3-T	UT137FG-x-TA3-T	TO-220	MT1	MT2	G	Tube
UT137GL-x-TA3-T	UT137GP-x-TA3-T	TO-220	MT1	MT2	G	Tube

Note: Pin Assignment: G: Gate

	<p>(1) T: Tube (2) TA3: TO-220 (3) 5: 500V, 6: 600V, 8: 800V (4) L: Lead Free, G: Halogen Free and Lead Free P: Halogen Free and Lead Free</p>
--	--

■ MARKING

UT137F	UT137G

■ ABSOLUTE MAXIMUM RATING

PARAMETER		SYMBOL	RATINGS	UNIT
Repetitive peak off-state voltages	UT137F_G-5	V _{DRM}	500 (Note 2)	V
	UT137F_G-6		600 (Note 2)	V
	UT137F_G-8		800	V
RMS on-state current full sine wave; T _{mb} ≤ 102°C		I _{T(RMS)}	8	A
Non-repetitive peak on-state current (Full sine wave; T _J = 25°C prior to surge)	t = 20ms	I _{TSM}	65	A
	t = 16.7 ms		71	
I ² t for fusing	t = 10 ms	I ² t	21	A ² s
Repetitive rate of rise of on-state current after triggering I _{TM} =12A; I _G =0.2A; dI _G /dt=0.2A/μs	T2+ G+	dI _T /dt	50	A/μs
	T2+ G-		50	A/μs
	T2- G-		50	A/μs
	T2- G+		10	A/μs
Peak gate voltage		V _{GM}	5	V
Peak gate current		I _{GM}	2	A
Peak gate power		P _{GM}	5	W
Average gate power (over any 20 ms period)		P _{G(AV)}	0.5	W
Junction Temperature		T _J	125	°C
Storage Temperature		T _{STG}	-40 ~ +150	°C

Note: 1. Absolute maximum ratings are those values beyond which the device could be permanently damaged. Absolute maximum ratings are stress ratings only and functional device operation is not implied.

2. Although not recommended, off-state voltages up to 800V may be applied without damage, but the triac may switch to the on-state. The rate of rise of current should not exceed 6A/μs.

■ THERMAL RESISTANCES

PARAMETER		SYMBOL	MIN	TYP	MAX	UNIT
Thermal resistance Junction to Ambient	In Free Air	θ _{JA}		60		°C/W
Thermal resistance Junction to mounting base	Full cycle	θ _{JC}			2.0	°C/W
	Half cycle				2.4	°C/W

■ STATIC CHARACTERISTICS (T_J=25°C, unless otherwise specified)

PARAMETER	SYMBOL	TEST CONDITIONS	MIN	TYP	MAX		UNIT		
					UT137F	UT137G			
Gate Trigger Current	I _{GT}	V _D =12V, I _T =0.1A			T2+G+	5	25	50	mA
					T2+G-	8	25	50	
					T2-G-	11	25	50	
					T2-G+	30	70	100	
Latching Current	I _L	V _D =12V, I _{GT} =0.1A			T2+G+	7	30	45	mA
					T2+G-	16	45	60	
					T2-G-	5	30	45	
					T2-G+	7	45	60	
Holding Current	I _H	V _D =12V, I _{GT} =0.1A		5	20	40	mA		
On-State Voltage	V _T	I _T =10A		1.3	1.65		V		
Gate Trigger Voltage	V _{GT}	V _D =12V, I _T =0.1A		0.7	1.5		V		
		V _D =400V, I _T =0.1A, T _J =125°C	0.25	0.4			V		
Off-State Leakage Current	I _D	V _D =V _{DRM(max)} , T _J =125°C		0.1	0.5		mA		

■ DYNAMIC CHARACTERISTICS ($T_J=25^\circ\text{C}$, unless otherwise specified)

PARAMETER	SYMBOL	TEST CONDITIONS	MIN		TYP	MAX	UNIT
			UT137F	UT137G			
Critical Rate Of Rise Of Off-State Voltage	dV_D/dt	$V_{DM}=67\% V_{DRM(max)}$, $T_J=125^\circ\text{C}$, Exponential waveform, gate open circuit	50	200	250		V/ μs
Critical Rate Of Change Of Commutating Voltage	dV_{com}/dt	$V_{DM}=400\text{V}$, $T_J=95^\circ\text{C}$, $I_{T(RMS)}=8\text{A}$, $dI_{com}/dt=3.6\text{A/ms}$, gate open circuit		10	20		V/ μs
Gate Controlled Turn-On Time	t_{gt}	$I_{TM}=12\text{A}$, $V_D=V_{DRM(max)}$, $I_G=0.1\text{A}$, $dI_G/dt=5\text{A}/\mu\text{s}$			2		μs

TYPICAL CHARACTERISTICS

Maximum On -State Dissipation. P_{tot} vs RMS On-State Current, $I_{T(RMS)}$, Where α =conduction Angle

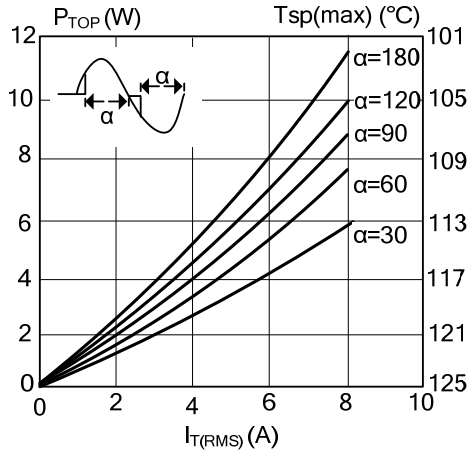

Maximum Permissible RMS Current $I_{T(RMS)}$ vs Mounting Base Temperature T_{mb}

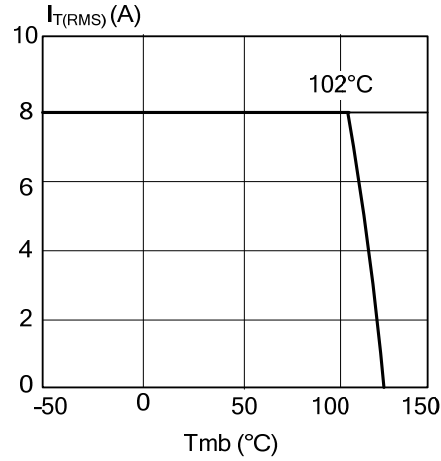

Maximum Permissible Non-Repetitive Peak On-State Current I_{TSM} , vs Pulse Width t_p , for Sinusoidal Currents, $t_p \leq 20ms$

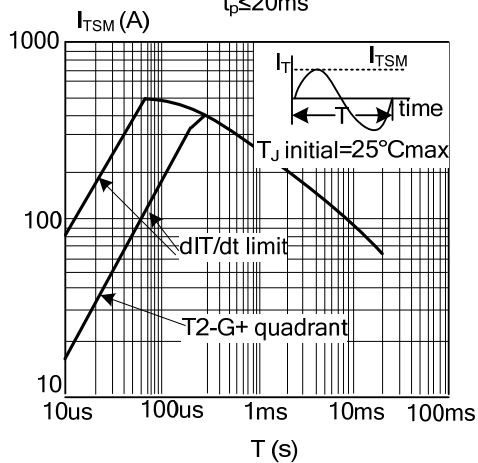

Maximum Permissible Repetitive RMS On-State Current $I_{T(RMS)}$, vs Surge Duration, for Sinusoidal Currents, $f=50Hz$, $T_{mb} \leq 102^\circ C$

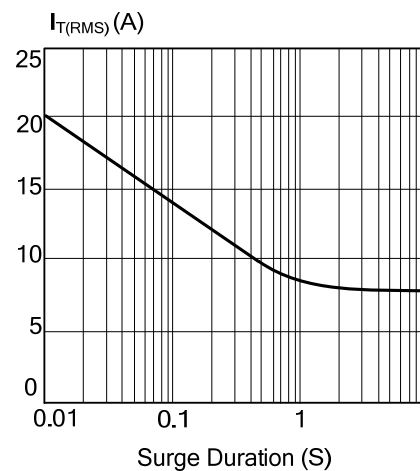

Maximum Permissible Non-Repetitive Peak On-State Current I_{TSM} , vs Number of Cycles, for Sinusoidal Currents, $f=50Hz$

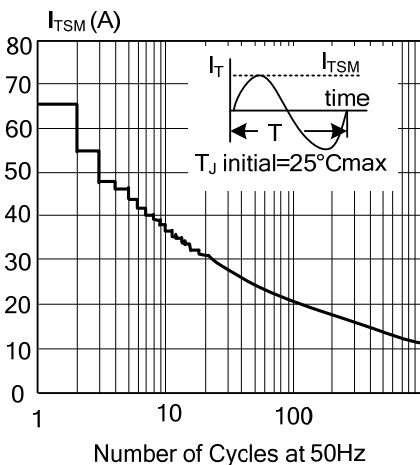

Normalised Gate Trigger Voltage $V_{GT}(T_J)/V_{GT}(25^\circ C)$, vs Junction Temperature T_J

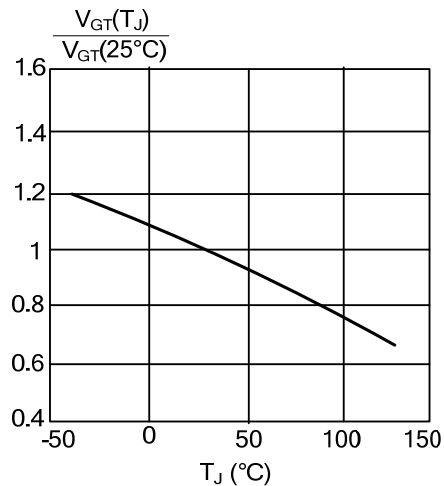

■ TYPICAL CHARACTERISTICS(Cont.)

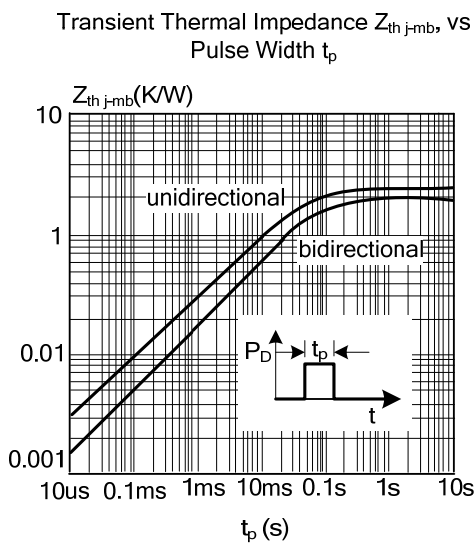
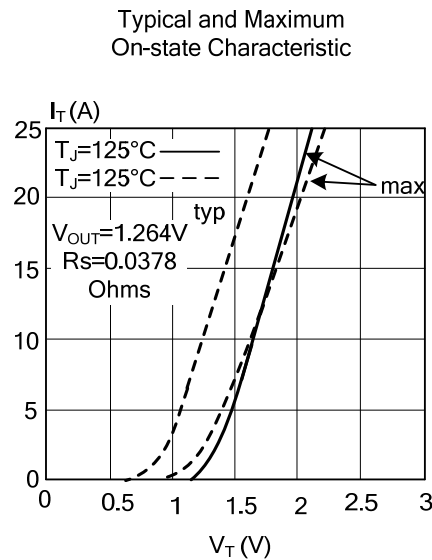
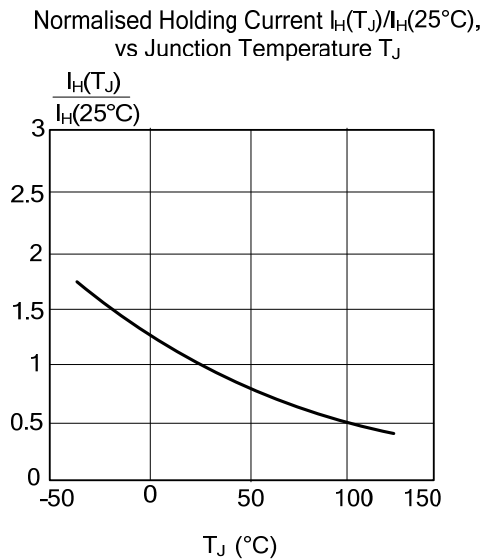
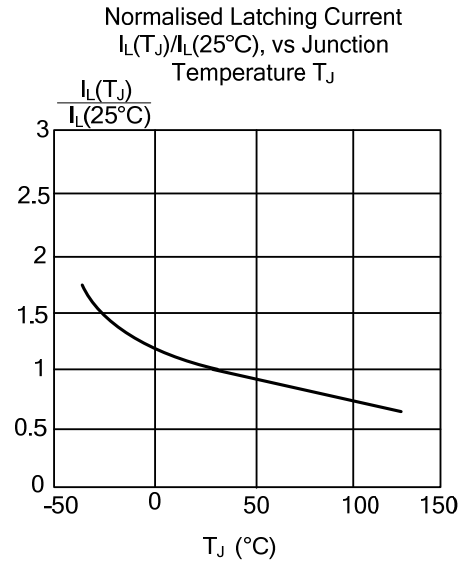
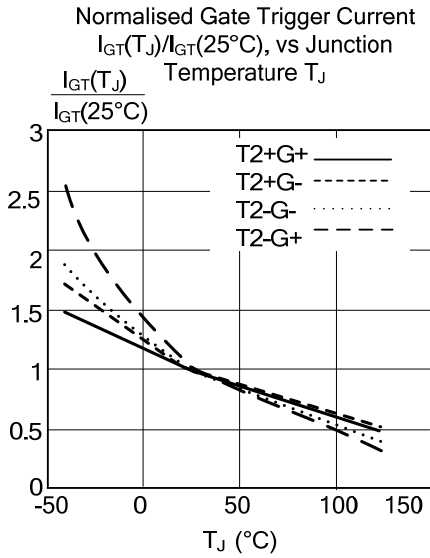

Typical Commutation dV/dt Vs Junction Temperature, Parameter Commutation dI_T/dt . The Triac Should Commutate When The dV/dt Is Below The Value On The Appropriate Curve For Pre-Commutation dI_T/dt

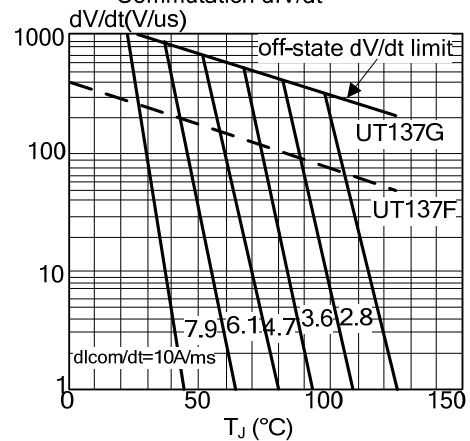

UTC assumes no responsibility for equipment failures that result from using products at values that exceed, even momentarily, rated values (such as maximum ratings, operating condition ranges, or other parameters) listed in products specifications of any and all UTC products described or contained herein. UTC products are not designed for use in life support appliances, devices or systems where malfunction of these products can be reasonably expected to result in personal injury. Reproduction in whole or in part is prohibited without the prior written consent of the copyright owner. The information presented in this document does not form part of any quotation or contract, is believed to be accurate and reliable and may be changed without notice.