



## UT2321

Power MOSFET

### P-CHANNEL ENHANCEMENT MODE FIELD EFFECT TRANSISTOR

#### DESCRIPTION

The **UT2321** uses advanced trench technology to provide excellent  $R_{DS(ON)}$ , low gate charge and operation with low gate voltages. This device is suitable for use as a load switch or in PWM applications.

#### FEATURES

- \*  $R_{DS(ON)} < 55m\Omega$  @  $V_{GS} = -4.5V$
- \*  $R_{DS(ON)} < 80m\Omega$  @  $V_{GS} = -2.5V$
- \* Low capacitance
- \* Low gate charge
- \* Fast switching capability
- \* Avalanche energy specified

#### SYMBOL

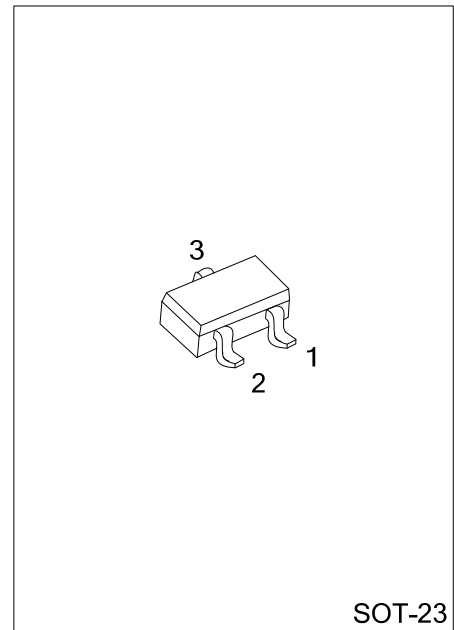
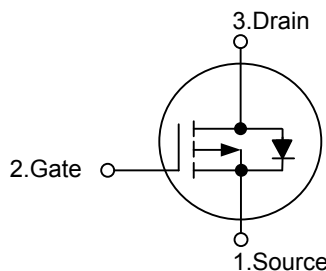

#### ORDERING INFORMATION

Ordering Number		Package	Pin Assignment			Packing
Lead Free	Halogen Free		1	2	3	
UT2321L-AE3-R	UT2321G-AE3-R	SOT-23	S	G	D	Tape Reel

<p>UT2321L-AE3-R</p> <p>(1) Packing Type</p> <p>(2) Package Type</p> <p>(3) Lead Plating</p>	<p>(1) R: Tape Reel</p> <p>(2) AE3: SOT-23</p> <p>(3) G: Halogen Free, L: Lead Free</p>
--	---

#### MARKING

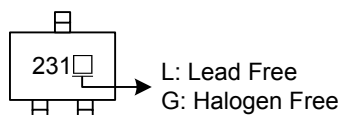

■ ABSOLUTE MAXIMUM RATINGS (Ta=25°C, unless otherwise specified)

PARAMETER	SYMBOL	RATINGS	UNIT
Drain-Source Voltage	V <sub>DSS</sub>	-20	V
Gate-Source Voltage	V <sub>GSS</sub>	±12	V
Continuous Drain Current (Note 2)	I <sub>D</sub>	-3.8	A
Pulsed Drain Current (Note 2)	I <sub>DM</sub>	-15.2	A
Power Dissipation	P <sub>D</sub>	1.25	W
Junction Temperature	T <sub>J</sub>	+150	°C
Storage Temperature	T <sub>STG</sub>	-55 ~ +150	°C

Note: 1. Absolute maximum ratings are those values beyond which the device could be permanently damaged.

Absolute maximum ratings are stress ratings only and functional device operation is not implied.

2. Pulse width limited by T<sub>J(MAX)</sub>

■ THERMAL DATA

PARAMETER	SYMBOL	MIN	TYP	MAX	UNIT
Junction to Ambient	θ <sub>JA</sub>			100	°C/W

■ ELECTRICAL CHARACTERISTICS (T<sub>J</sub>=25°C, unless otherwise specified)

PARAMETER	SYMBOL	TEST CONDITIONS	MIN	TYP	MAX	UNIT
<b>OFF CHARACTERISTICS</b>						
Drain-Source Breakdown Voltage	BV <sub>DSS</sub>	V <sub>GS</sub> =0V, I <sub>D</sub> =-250μA	-20			V
Drain-Source Leakage Current	I <sub>DSS</sub>	V <sub>DS</sub> =-16V, V <sub>GS</sub> =0V			-1	μA
Gate-Source Leakage Current	I <sub>GSS</sub>	Forward			100	nA
		Reverse	V <sub>GS</sub> =-12V, V <sub>DS</sub> =0V			-100
<b>ON CHARACTERISTICS(Note)</b>						
Gate-Threshold Voltage	V <sub>GS(TH)</sub>	V <sub>DS</sub> =V <sub>GS</sub> , I <sub>D</sub> =-250μA	-0.4		-1.0	V
Static Drain-Source On-Resistance	R <sub>DS(ON)</sub>	V <sub>GS</sub> =-4.5V, I <sub>D</sub> =-2.4A		45	55	mΩ
		V <sub>GS</sub> =-2.5V, I <sub>D</sub> =-2.0A		65	80	mΩ
<b>DYNAMIC PARAMETERS</b>						
Input Capacitance	C <sub>ISS</sub>	V <sub>DS</sub> =-10 V, V <sub>GS</sub> =0V, f=1.0MHz		1500		pF
Output Capacitance	C <sub>OSS</sub>			270		pF
Reverse Transfer Capacitance	C <sub>RSS</sub>			185		pF
<b>SWITCHING PARAMETERS</b>						
Total Gate Charge	Q <sub>G</sub>	V <sub>DS</sub> =-10V, V <sub>GS</sub> =-4.5V, I <sub>D</sub> =-2.4A		14.8	19	nC
Gate-Source Charge	Q <sub>GS</sub>			2.8		nC
Gate-Drain Charge	Q <sub>GD</sub>			4.4		nC
Turn-ON Delay Time	t <sub>D(ON)</sub>	V <sub>DD</sub> =-10V, I <sub>D</sub> =-1A, V <sub>GS</sub> =-4.5V, R <sub>GEN</sub> =6 Ω		13	24	ns
Turn-ON Rise Time	t <sub>R</sub>			8	24	ns
Turn-OFF Delay Time	t <sub>D(OFF)</sub>			65	256	ns
Turn-OFF Fall-Time	t <sub>F</sub>			29	72	ns
<b>DRAIN-SOURCE DIODE CHARACTERISTICS AND MAXIMUM RATINGS</b>						
Diode Forward Voltage(Note)	V <sub>SD</sub>	V <sub>GS</sub> =0V, I <sub>S</sub> =-0.42A			-1.2	V
Maximum Body-Diode Continuous Current	I <sub>S</sub>				-0.42	A

Note: Pulse Test: Pulse Width ≤ 300μs, Duty Cycle ≤ 2%.

## TYPICAL CHARACTERISTICS

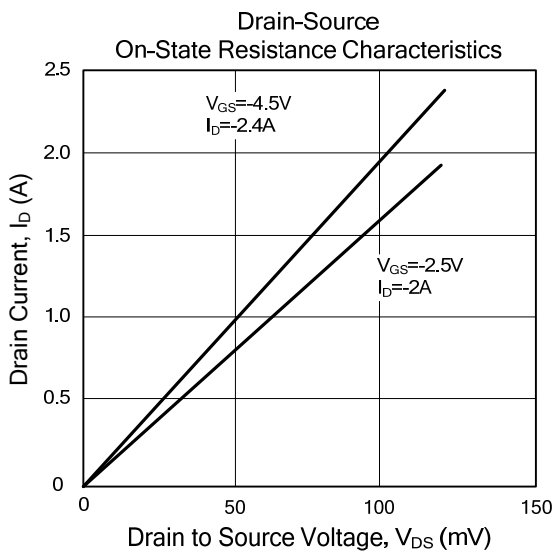
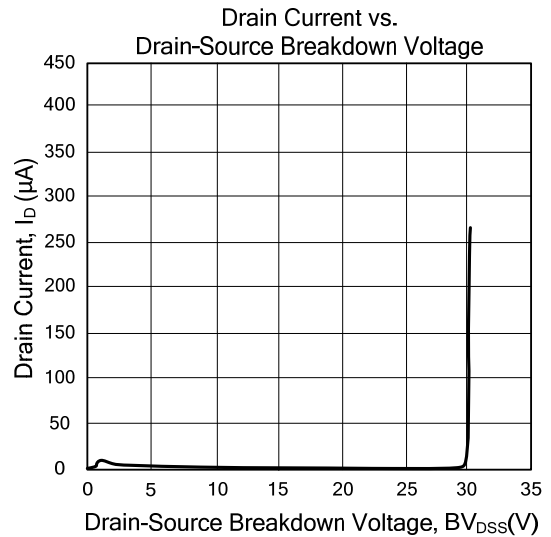
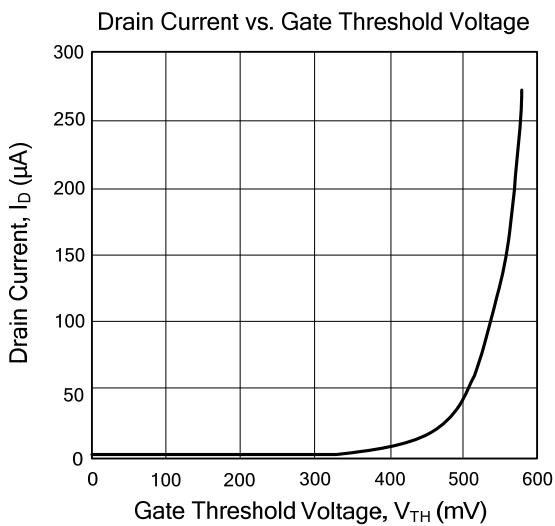
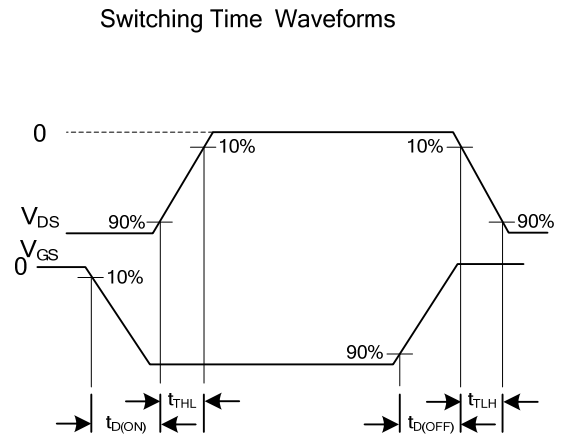
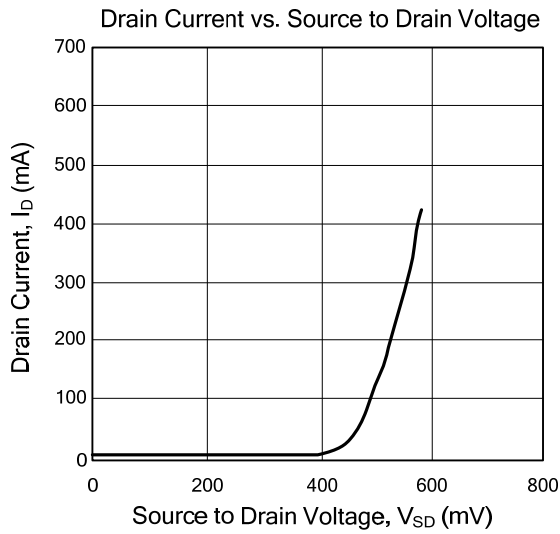

UTC assumes no responsibility for equipment failures that result from using products at values that exceed, even momentarily, rated values (such as maximum ratings, operating condition ranges, or other parameters) listed in products specifications of any and all UTC products described or contained herein. UTC products are not designed for use in life support appliances, devices or systems where malfunction of these products can be reasonably expected to result in personal injury. Reproduction in whole or in part is prohibited without the prior written consent of the copyright owner. The information presented in this document does not form part of any quotation or contract, is believed to be accurate and reliable and may be changed without notice.