



UT2321

Power MOSFET

P-CHANNEL ENHANCEMENT MODE FIELD EFFECT TRANSISTOR

DESCRIPTION

The **UT2321** uses advanced trench technology to provide excellent $R_{DS(ON)}$, low gate charge and operation with low gate voltages. This device is suitable for use as a load switch or in PWM applications.

FEATURES

- * $R_{DS(ON)} \leq 55m\Omega @ V_{GS}=-4.5V, I_D=-2.4A$
- * $R_{DS(ON)} \leq 80m\Omega @ V_{GS}=-2.5V, I_D=-2.0A$
- * Low capacitance
- * Low gate charge
- * Fast switching capability
- * Avalanche energy specified

SYMBOL

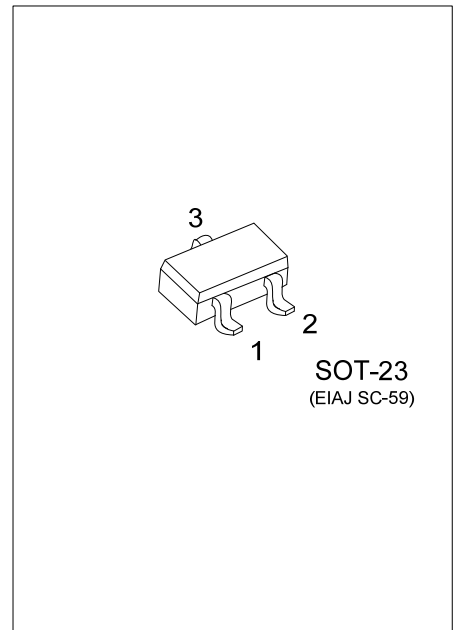
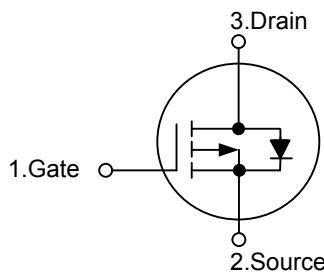

ORDERING INFORMATION

Ordering Number		Package	Pin Assignment			Packing
Lead Free	Halogen Free		1	2	3	
UT2321L-AE3-R	UT2321G-AE3-R	SOT-23	G	S	D	Tape Reel

Note: Pin Assignment: G: Gate S: Source D: Drain

<p>UT2321G-AE3-R</p>	<p>(1) Packing Type</p> <p>(2) Package Type</p> <p>(3) Green Package</p>	<p>(1) R: Tape Reel</p> <p>(2) AE3: SOT-23</p> <p>(3) G: Halogen Free and Lead Free, L: Lead Free</p>
----------------------	--------------------------------------------------------------------------	-------------------------------------------------------------------------------------------------------

MARKING

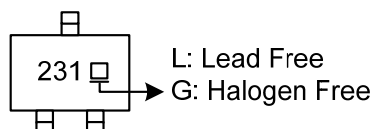

■ ABSOLUTE MAXIMUM RATINGS (T_A=25°C, unless otherwise specified)

PARAMETER	SYMBOL	RATINGS	UNIT
Drain-Source Voltage	V _{DSS}	-20	V
Gate-Source Voltage	V _{GSS}	±12	V
Continuous Drain Current (Note 2)	I _D	-3.8	A
Pulsed Drain Current (Note 2)	I _{DM}	-15.2	A
Power Dissipation (Note 3)	P _D	1.25	W
Junction Temperature	T _J	+150	°C
Storage Temperature	T _{STG}	-55 ~ +150	°C

Notes: 1. Absolute maximum ratings are those values beyond which the device could be permanently damaged.

Absolute maximum ratings are stress ratings only and functional device operation is not implied.

2. Pulse width limited by T_{J(MAX)}

3. Surface mounted on 1 in 2 copper pad of FR4 board.

■ THERMAL CHARACTERISTICS

PARAMETER	SYMBOL	RATINGS	UNIT
Junction to Ambient	θ _{JA}	100	°C/W

■ ELECTRICAL CHARACTERISTICS (T_J=25°C, unless otherwise specified)

PARAMETER	SYMBOL	TEST CONDITIONS	MIN	TYP	MAX	UNIT
OFF CHARACTERISTICS						
Drain-Source Breakdown Voltage	BV _{DSS}	V _{GS} =0V, I _D =-250μA	-20			V
Drain-Source Leakage Current	I _{DSS}	V _{DS} =-16V, V _{GS} =0V			-1	μA
Gate-Source Leakage Current	I _{GSS}	Forward			100	nA
		Reverse			-100	nA
ON CHARACTERISTICS(Note)						
Gate-Threshold Voltage	V _{GS(TH)}	V _{DS} =V _{GS} , I _D =-250μA	-0.4		-1.0	V
Static Drain-Source On-Resistance	R _{DS(ON)}	V _{GS} =-4.5V, I _D =-2.4A		45	55	mΩ
		V _{GS} =-2.5V, I _D =-2.0A		65	80	mΩ
DYNAMIC PARAMETERS						
Input Capacitance	C _{ISS}	V _{DS} =-10 V, V _{GS} =0V, f=1.0MHz		1500		pF
Output Capacitance	C _{OSS}			270		pF
Reverse Transfer Capacitance	C _{RSS}			185		pF
SWITCHING PARAMETERS						
Total Gate Charge	Q _G	V _{DS} =-10V, V _{GS} =-4.5V, I _D =-2.4A		14.8	19	nC
Gate-Source Charge	Q _{GS}			2.8		nC
Gate-Drain Charge	Q _{GD}			4.4		nC
Turn-ON Delay Time	t _{D(ON)}	V _{DD} =-10V, I _D =-1A, V _{GS} =-4.5V, R _{GEN} =6 Ω		13	24	ns
Turn-ON Rise Time	t _R			8	24	ns
Turn-OFF Delay Time	t _{D(OFF)}			65	256	ns
Turn-OFF Fall-Time	t _F			29	72	ns
DRAIN-SOURCE DIODE CHARACTERISTICS AND MAXIMUM RATINGS						
Diode Forward Voltage(Note)	V _{SD}	V _{GS} =0V, I _S =-0.42A			-1.2	V
Maximum Body-Diode Continuous Current	I _S				-0.42	A

Note: Pulse Test: Pulse Width ≤ 300μs, Duty Cycle ≤ 2%.

TYPICAL CHARACTERISTICS

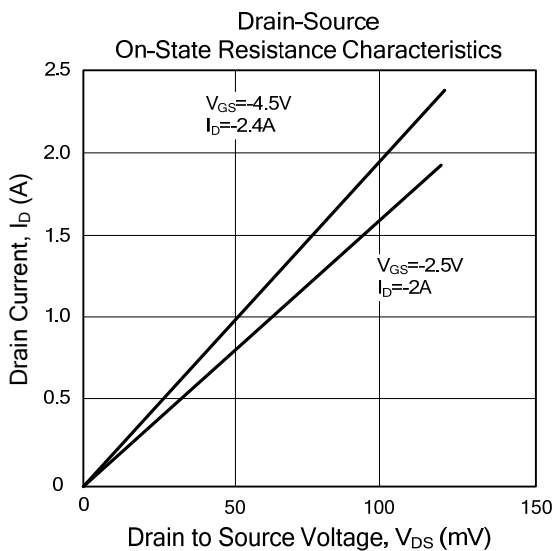
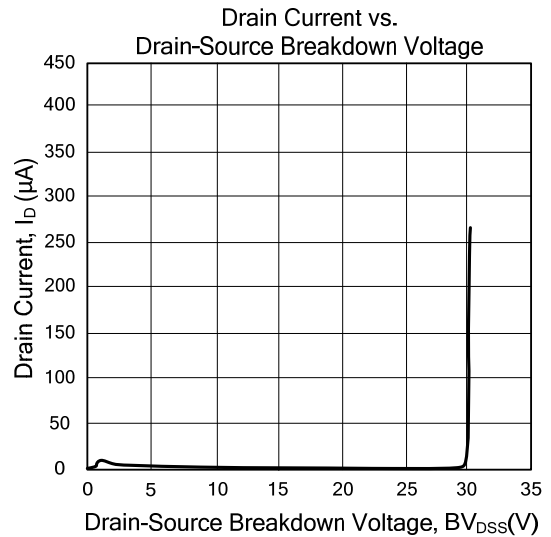
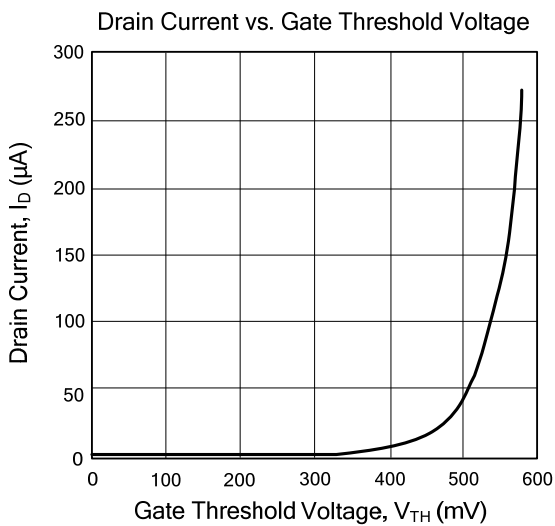
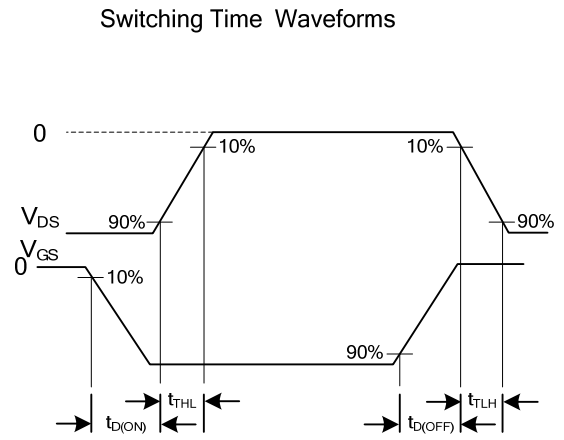
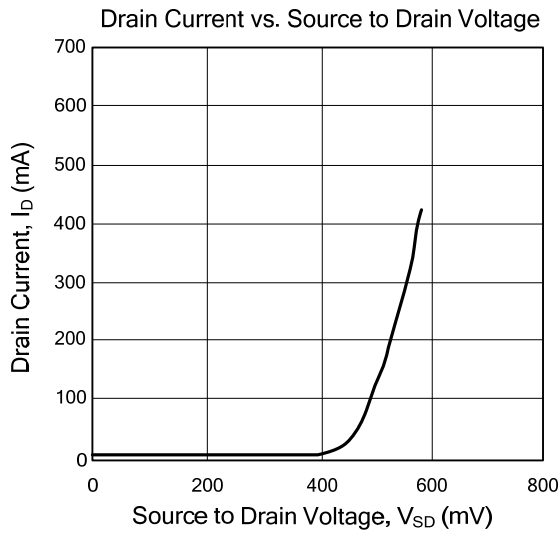

UTC assumes no responsibility for equipment failures that result from using products at values that exceed, even momentarily, rated values (such as maximum ratings, operating condition ranges, or other parameters) listed in products specifications of any and all UTC products described or contained herein. UTC products are not designed for use in life support appliances, devices or systems where malfunction of these products can be reasonably expected to result in personal injury. Reproduction in whole or in part is prohibited without the prior written consent of the copyright owner. UTC reserves the right to make changes to information published in this document, including without limitation specifications and product descriptions, at any time and without notice. This document supersedes and replaces all information supplied prior to the publication hereof.