



REVISION HISTORY

REVISION	DESCRIPTION	Date
Preliminary Rev. 0.5	Original.	Mar, 2001
Rev.1.0	1. Revised Features -Access time 70/100ns→55/70/100ns -Operating current 5mA(I _{cc1,max})→45/35/25mA(I _{cc max}) -Standby current 80/25uA(max)→20/2uA(typ) -V _{cc} power supply 2.7~3.3V→2.5~3.6V 2. Revised Function block diagram 3. Revised DC electrical characteristics table 4. Revised AC electrical characteristics table 5. Revised Timing waveforms 6. Revised Data retention characteristics table & waveform 7. Revised 48 TFBGA outline dimension, ball size 0.3mm→0.35mm 8. Revised order information	May 15,2003



FEATURES

- Fast access time :
55ns (max.) for Vcc=2.7V~3.6V
70/100ns (max.) for Vcc=2.5V~3.6V
- CMOS low power operating
Operating current : 45/35/25mA (Icc max.)
Standby current : 20uA(max.) L-version
2uA(max.) LL-version
- Single 2.5V~3.6V power supply
- Operating temperature:
Commercial : 0 ~70
Industrial : -40 ~85
- All TTL compatible inputs and outputs
- Fully static operation
- Three state outputs
- Data retention voltage : 1.5V (min.)
- Data byte control : \overline{LB} (I/O1~I/O8)
 \overline{UB} (I/O9~I/O16)
- Package : 48-pin 6mm x 8mm TFBGA

GENERAL DESCRIPTION

The UT62L12916 is a 2,097,152-bit low power CMOS static random access memory organized as 131,072 words by 16 bits.

The UT62L12916 operates from a single 2.5V ~ 3.6V power supply and all inputs and outputs are fully TTL compatible.

The UT62L12916 is designed for low power system applications. It is particularly well suited for use in high-density low power system applications.

FUNCTIONAL BLOCK DIAGRAM

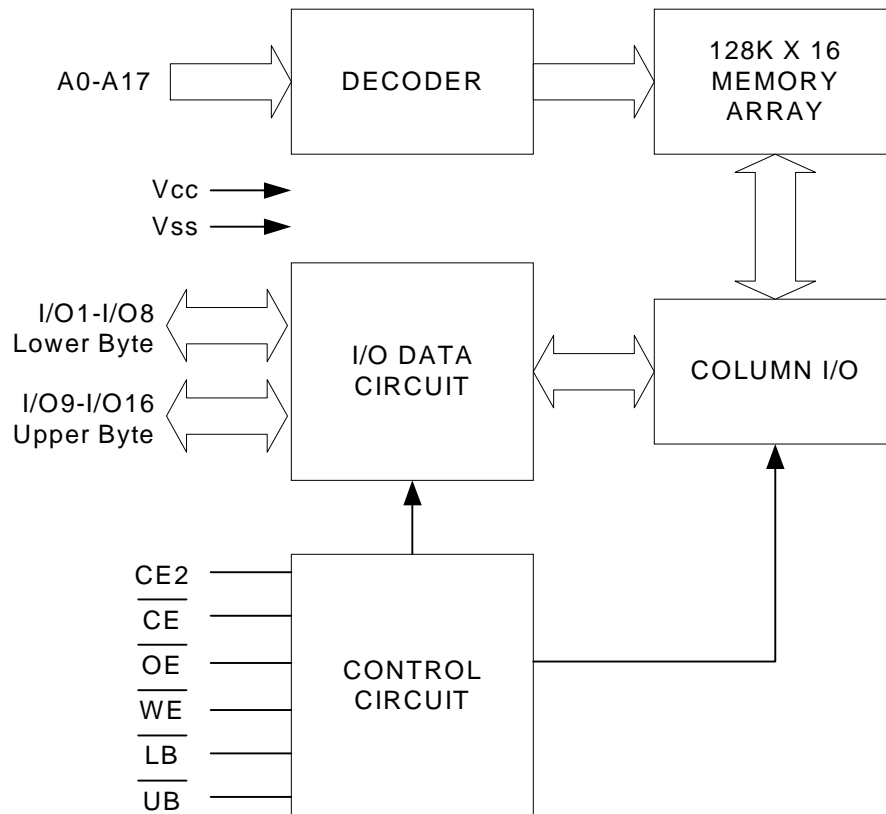



PIN CONFIGURATION

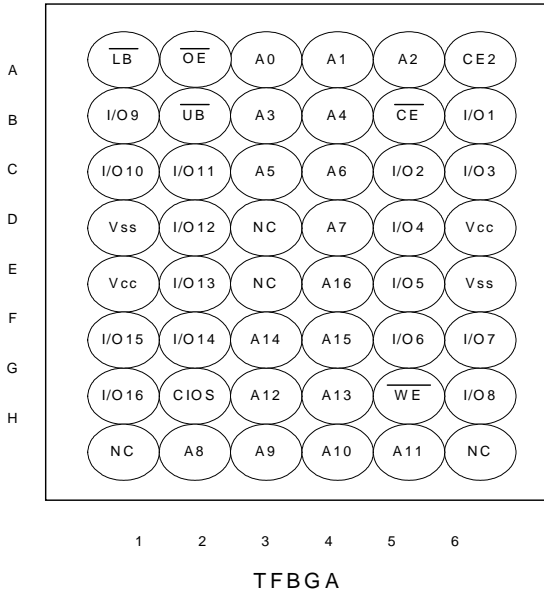

PIN DESCRIPTION

SYMBOL	DESCRIPTION
A0 - A17	Address Inputs
I/O1 - I/O16	Data Inputs/Outputs
\overline{CE} , CE2	Chip Enable Input
\overline{WE}	Write Enable Input
\overline{OE}	Output Enable Input
\overline{LB}	Lower-byte Control
\overline{UB}	Upper-byte Control
V _{CC}	Power Supply
V _{SS}	Ground
NC	No Connection

TRUTH TABLE

MODE	\overline{CE}	CE2	\overline{OE}	\overline{WE}	\overline{LB}	\overline{UB}	I/O OPERATION		SUPPLY CURRENT
							I/O1-I/O8	I/O9-I/O16	
Standby	H	X	X	X	X	X	High - Z	High - Z	I _{SB} , I _{SB1}
	X	L	X	X	X	X	High - Z	High - Z	
	X	X	X	X	H	H	High - Z	High - Z	
Output Disable	L	H	H	H	L	X	High - Z	High - Z	I _{CC} , I _{CC1} , I _{CC2}
	L	H	H	H	X	L	High - Z	High - Z	
Read	L	H	L	H	L	H	D _{OUT}	High - Z	I _{CC} , I _{CC1} , I _{CC2}
	L	H	L	H	H	L	High - Z	D _{OUT}	
	L	H	L	H	L	L	D _{OUT}	D _{OUT}	
Write	L	H	X	L	L	H	D _{IN}	High - Z	I _{CC} , I _{CC1} , I _{CC2}
	L	H	X	L	H	L	High - Z	D _{IN}	
	L	H	X	L	L	L	D _{IN}	D _{IN}	

Note: H = V_{IH}, L = V_{IL}, X = Don't care.

**ABSOLUTE MAXIMUM RATINGS***

PARAMETER	SYMBOL	RATING	UNIT
Terminal Voltage with Respect to V_{SS}	V_{TERM}	-0.5 to 4.6	V
Operating Temperature	Commercial	T_A	0 to 70
	Industrial	T_A	-40 to 85
Storage Temperature	T_{STG}	-65 to 150	
Power Dissipation	P_D	1	W
DC Output Current	I_{OUT}	50	mA
Soldering Temperature (under 10 secs)	T_{solder}	260	

*Stresses greater than those listed under "Absolute Maximum Ratings" may cause permanent damage to the device. This is a stress rating only and functional operation of the device or any other conditions above those indicated in the operational sections of this specification is not implied. Exposure to the absolute maximum rating conditions for extended period may affect device reliability.

DC ELECTRICAL CHARACTERISTICS ($T_A = 0$ to 70 / -40 to 85 (I))

PARAMETER	SYMBOL	TEST CONDITION	MIN.	TYP.	MAX.	UNIT	
Power Voltage	V_{CC}		55	2.7	3.0	3.6	V
			70/100	2.5	-	3.6	V
Input High Voltage	V_{IH}^{*1}		2.2	-	$V_{CC}+0.3$	V	
Input Low Voltage	V_{IL}^{*2}		-0.2	-	0.6	V	
Input Leakage Current	I_{LI}	$V_{SS} \quad V_{IN} \quad V_{CC}$	-1	-	1	μA	
Output Leakage Current	I_{LO}	$V_{SS} \quad V_{IO} \quad V_{CC}$; Output Disable	-1	-	1	μA	
Output High Voltage	V_{OH}	$I_{OH} = -1mA$	2.2	-	-	V	
Output Low Voltage	V_{OL}	$I_{OL} = 2.1mA$	-	-	0.4	V	
Operating Power Supply Current	I_{CC}	Cycle time=min, 100%duty $I/O=0mA, \overline{CE}=V_{IL}$	55	-	30	45	mA
			70	-	25	35	mA
			100	-	20	25	mA
Average Operation Current	I_{CC1}	100%duty, $I_{IO}=0mA, \overline{CE} = 0.2V$, other pins at 0.2V or $V_{CC}-0.2V$	$T_{cycle}=1\mu s$	-	4	5	mA
	I_{CC2}		$T_{cycle}=500ns$	-	8	10	mA
Standby Current (TTL)	I_{SB}	$\overline{CE}=V_{IH}$, other pins = V_{IL} or V_{IH}	-	0.3	0.5	mA	
Standby Current (CMOS)	I_{SB1}	$\overline{CE}=V_{CC}-0.2V$ other pins at 0.2V or $V_{CC}-0.2V$	-L	-	20	80	μA
			-LL	-	2	20	μA

Notes:

1. Overshoot : $V_{CC}+3.0v$ for pulse width less than 10ns.
2. Undershoot : $V_{SS}-3.0v$ for pulse width less than 10ns.
3. Overshoot and Undershoot are sampled, not 100% tested.

**CAPACITANCE** ($T_A=25$, $f=1.0\text{MHz}$)

PARAMETER	SYMBOL	MIN.	MAX	UNIT
Input Capacitance	C_{IN}	-	6	pF
Input/Output Capacitance	$C_{I/O}$	-	8	pF

Note : These parameters are guaranteed by device characterization, but not production tested.

AC TEST CONDITIONS

Input Pulse Levels	0V to 3.0V
Input Rise and Fall Times	5ns
Input and Output Timing Reference Levels	1.5V
Output Load	$C_L = 30\text{pF}$, $I_{OH}/I_{OL} = -1\text{mA}/2.1\text{mA}$

AC ELECTRICAL CHARACTERISTICS ($T_A = 0$ to 70 / -40 to 85 (I))**(1) READ CYCLE**

PARAMETER	SYMBOL	UT62L12916-55		UT62L12916-70		UT62L12916-100		UNIT
		MIN.	MAX.	MIN.	MAX.	MIN.	MAX.	
Read Cycle Time	t_{RC}	55	-	70	-	100	-	ns
Address Access Time	t_{AA}	-	55	-	70	-	100	ns
Chip Enable Access Time	t_{ACE}	-	55	-	70	-	100	ns
Output Enable Access Time	t_{OE}	-	30	-	35	-	50	ns
Chip Enable to Output in Low Z	t_{CLZ}^*	10	-	10	-	10	-	ns
Output Enable to Output in Low Z	t_{OLZ}^*	5	-	5	-	5	-	ns
Chip Disable to Output in High Z	t_{CHZ}^*	-	20	-	25	-	30	ns
Output Disable to Output in High Z	t_{OHZ}^*	-	20	-	25	-	30	ns
Output Hold from Address Change	t_{OH}	10	-	10	-	10	-	ns
\overline{LB} , \overline{UB} Access Time	t_{BA}	-	55	-	70	-	100	ns
\overline{LB} , \overline{UB} to High-Z Output	t_{BHZ}	-	25	-	30	-	40	ns
\overline{LB} , \overline{UB} to Low-Z Output	t_{BLZ}	10	-	10	-	10	-	ns

(2) WRITE CYCLE

PARAMETER	SYMBOL	UT62L12916-55		UT62L12916-70		UT62L12916-100		UNIT
		MIN.	MAX.	MIN.	MAX.	MIN.	MAX.	
Write Cycle Time	t_{WC}	55	-	70	-	100	-	ns
Address Valid to End of Write	t_{AW}	50	-	60	-	80	-	ns
Chip Enable to End of Write	t_{CW}	50	-	60	-	80	-	ns
Address Set-up Time	t_{AS}	0	-	0	-	0	-	ns
Write Pulse Width	t_{WP}	45	-	55	-	70	-	ns
Write Recovery Time	t_{WR}	0	-	0	-	0	-	ns
Data to Write Time Overlap	t_{DW}	25	-	30	-	40	-	ns
Data Hold from End of Write Time	t_{DH}	0	-	0	-	0	-	ns
Output Active from End of Write	t_{OW}^*	5	-	5	-	5	-	ns
Write to Output in High Z	t_{WHZ}^*	-	30	-	30	-	40	ns
\overline{LB} , \overline{UB} Valid to End of Write	t_{BW}	45	-	60	-	80	-	ns

* These parameters are guaranteed by device characterization, but not production tested.



TIMING WAVEFORMS

READ CYCLE 1 (Address Controlled) (1,2)

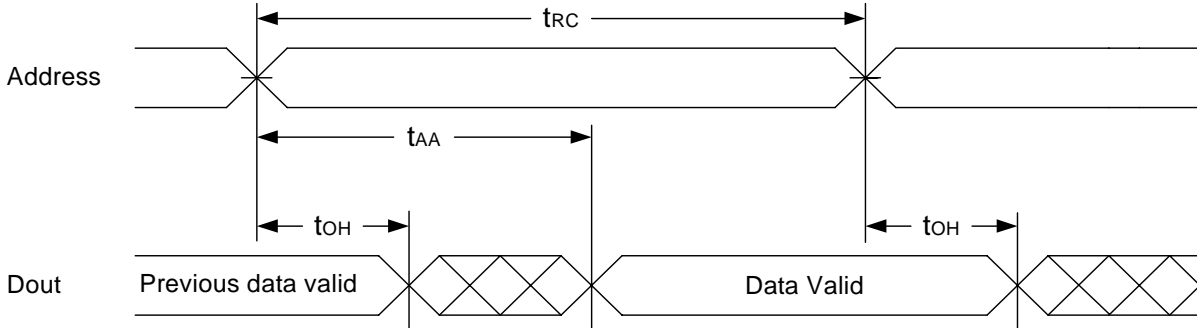

READ CYCLE 2 (\overline{CE} and CE2 and \overline{OE} Controlled) (1,3,4,5)

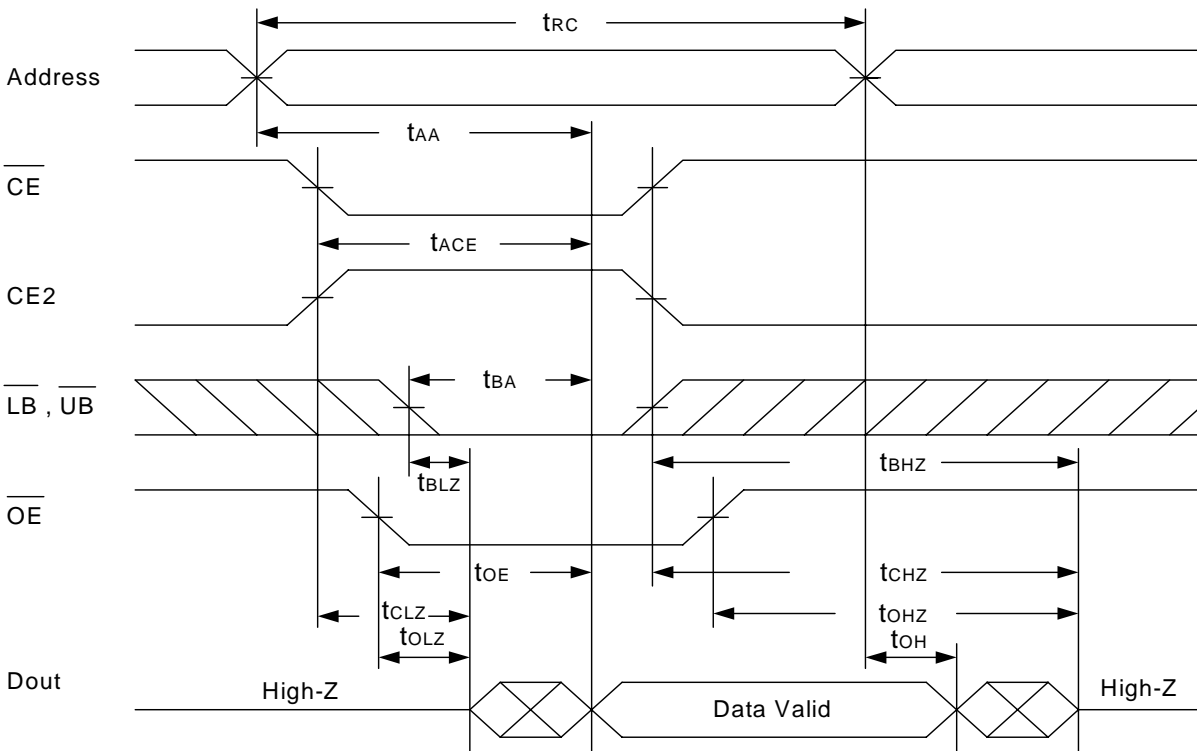

Notes :

1. \overline{WE} is high for read cycle.
2. Device is continuously selected \overline{OE} =low, \overline{CE} =low, CE2=high, \overline{LB} or \overline{UB} =low.
3. Address must be valid prior to or coincident with \overline{CE} =low, CE2=high, \overline{LB} or \overline{UB} =low transition; otherwise t_{AA} is the limiting parameter.
4. t_{CLZ} , t_{BLZ} , t_{OLZ} , t_{CHZ} , t_{BHZ} and t_{OHZ} are specified with $C_L=5pF$. Transition is measured $\pm 500mV$ from steady state.
5. At any given temperature and voltage condition, t_{CHZ} is less than t_{CLZ} , t_{BHZ} is less than t_{BLZ} , t_{OHZ} is less than t_{OLZ} .



WRITE CYCLE 1 (\overline{WE} Controlled) (1,2,3,5,6)

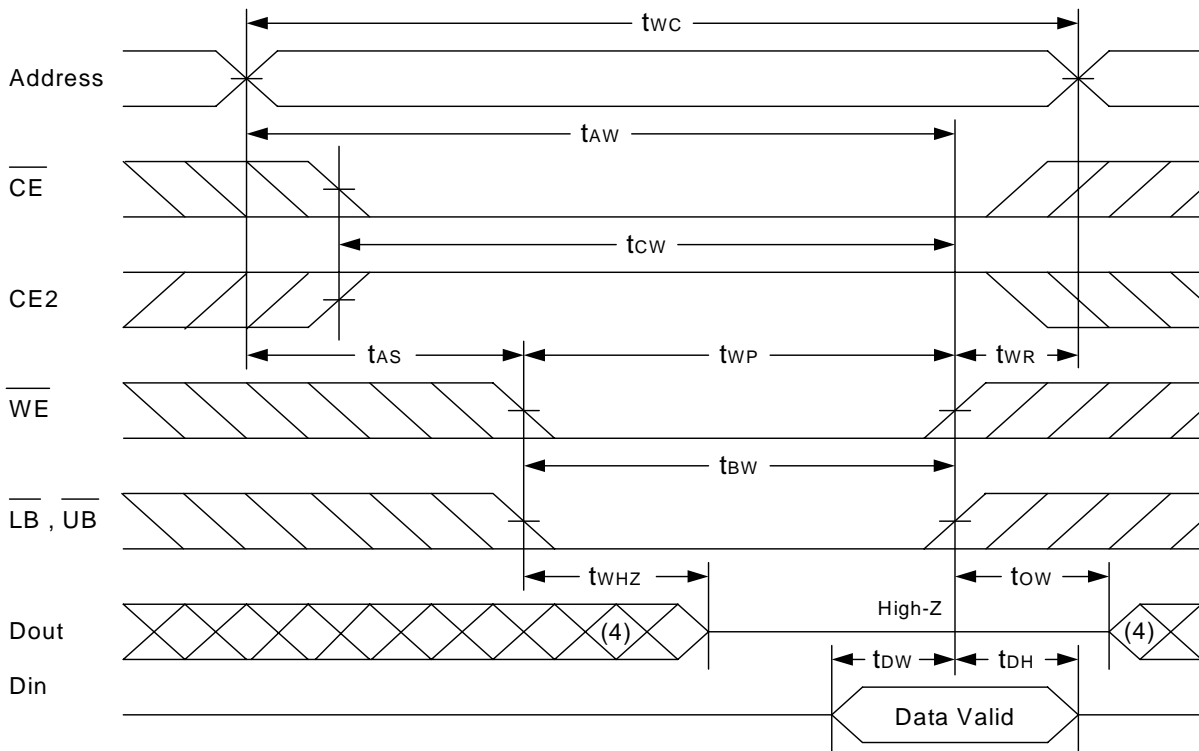

WRITE CYCLE 2 (\overline{CE} and $\overline{CE2}$ Controlled) (1,2,5,6)

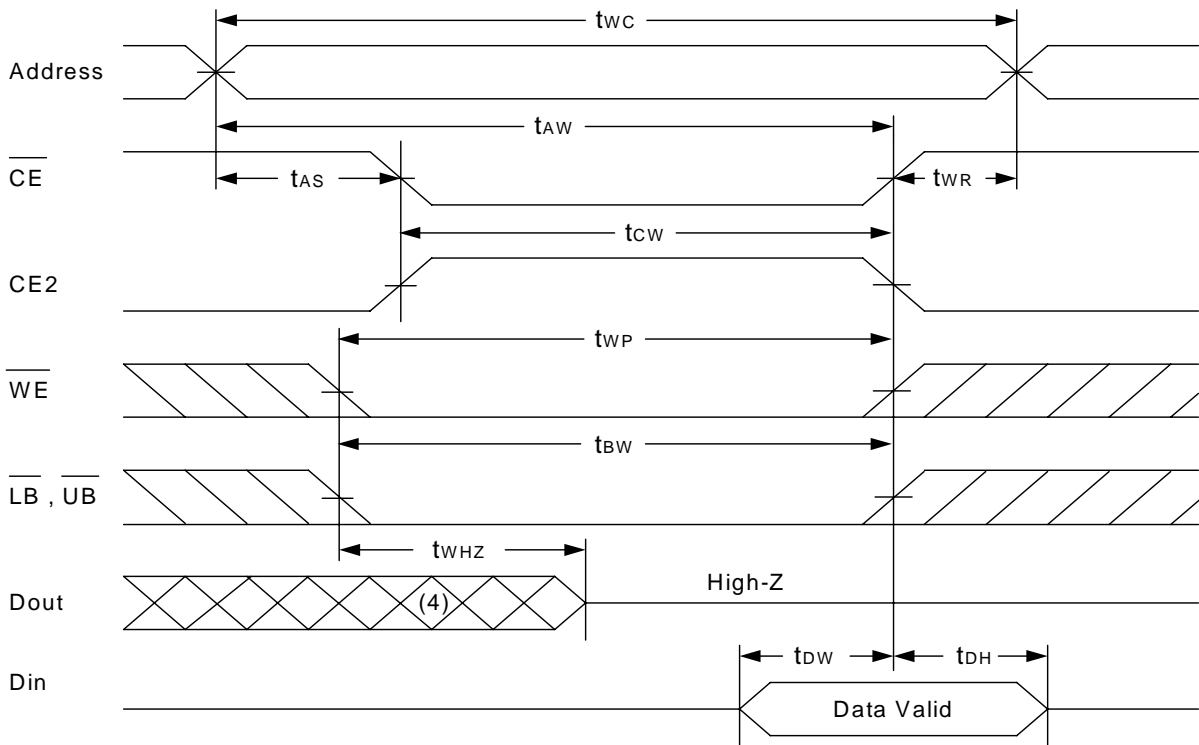



WRITE CYCLE 3 (\overline{LB} , \overline{UB} Controlled) (1,2,5,6)

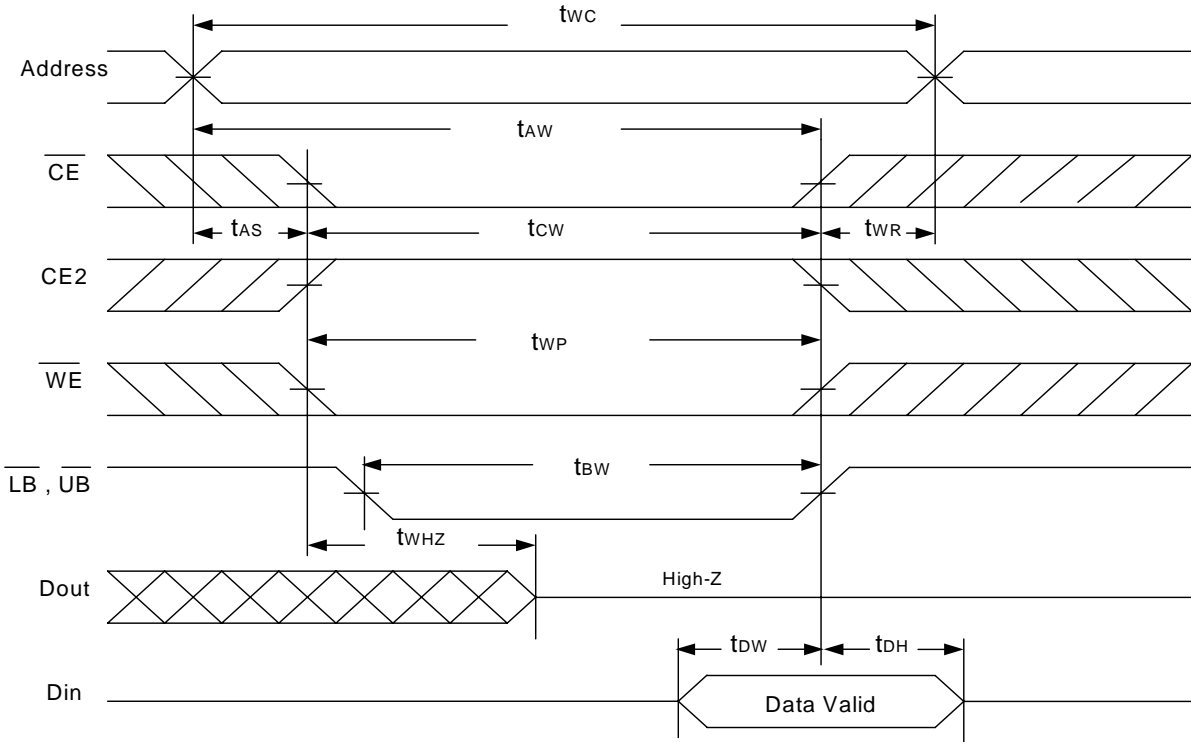

Notes :

1. \overline{WE} , \overline{CE} , \overline{LB} , \overline{UB} must be high or CE2 must be low during all address transitions.
2. A write occurs during the overlap of a low \overline{CE} , high CE2, low \overline{WE} , \overline{LB} or \overline{UB} = low.
3. During a \overline{WE} controlled write cycle with \overline{OE} low, t_{WP} must be greater than $t_{WHZ} + t_{DW}$ to allow the drivers to turn off and data to be placed on the bus.
4. During this period, I/O pins are in the output state, and input signals must not be applied.
5. If the \overline{CE} , \overline{LB} , \overline{UB} low transition and CE2 high transition occurs simultaneously with or after \overline{WE} low transition, the outputs remain in a high impedance state.
6. t_{OW} and t_{WHZ} are specified with $C_L = 5pF$. Transition is measured $\pm 500mV$ from steady state.



DATA RETENTION CHARACTERISTICS ($T_A = 0$ to 70 / -40 to 85 (I))

PARAMETER	SYMBOL	TEST CONDITION	MIN.	TYP.	MAX.	UNIT
Vcc for Data Retention	V _{DR}	\overline{CE} V _{CC} -0.2V or CE2 0.2V	1.5	-	3.6	V
Data Retention Current	I _{DR}	V _{CC} =1.5V	- L	1	50	μA
		\overline{CE} V _{CC} -0.2V or CE2 0.2V	- LL	0.5	20	μA
Chip Disable to Data Retention Time	t _{CDR}	See Data Retention Waveforms (below)	0	-	-	ms
Recovery Time	t _R		5	-	-	ms

DATA RETENTION WAVEFORM

Low Vcc Data Retention Waveform (1) (\overline{CE} controlled)

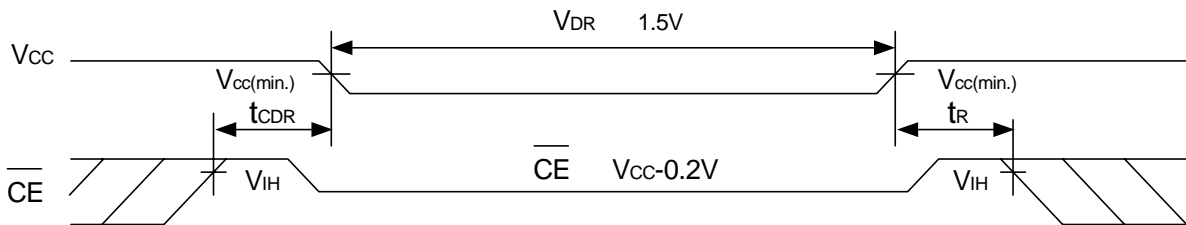

Low Vcc Data Retention Waveform (2) (CE2 controlled)

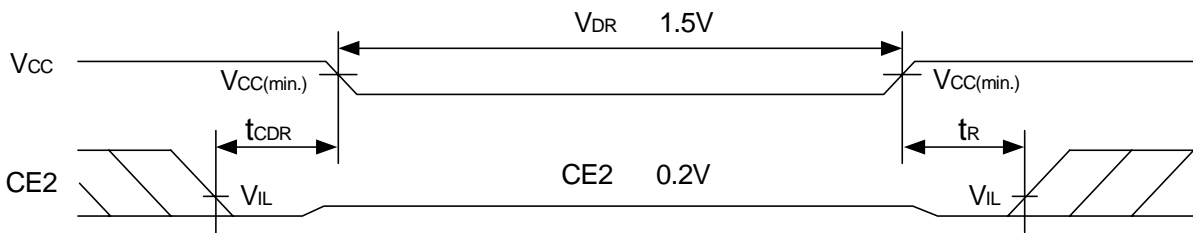

Low Vcc Data Retention Waveform (3) (\overline{LB} , \overline{UB} controlled)

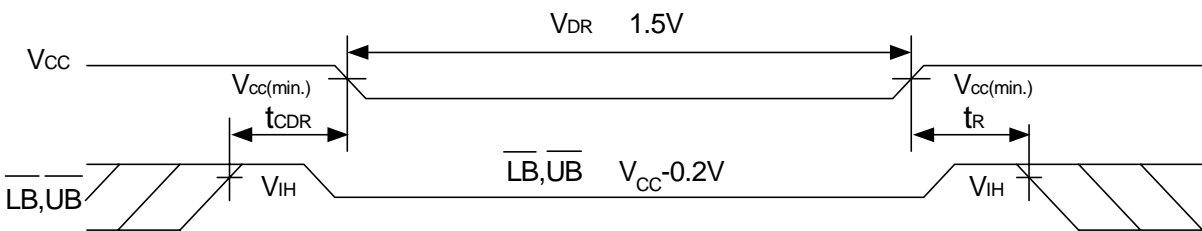



PACKAGE OUTLINE DIMENSION

48 pin 6.0mmX8.0mm TFBGA Package Outline Dimension

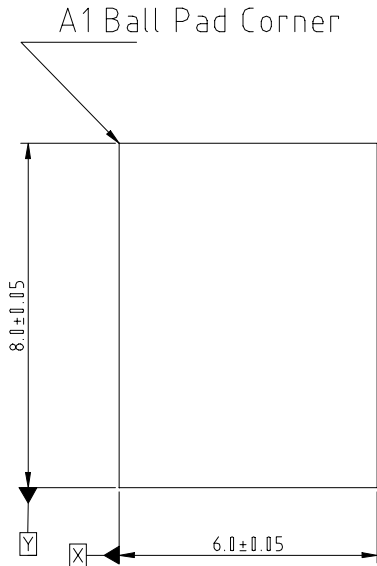

TOP VIEW (DIE VIEW)

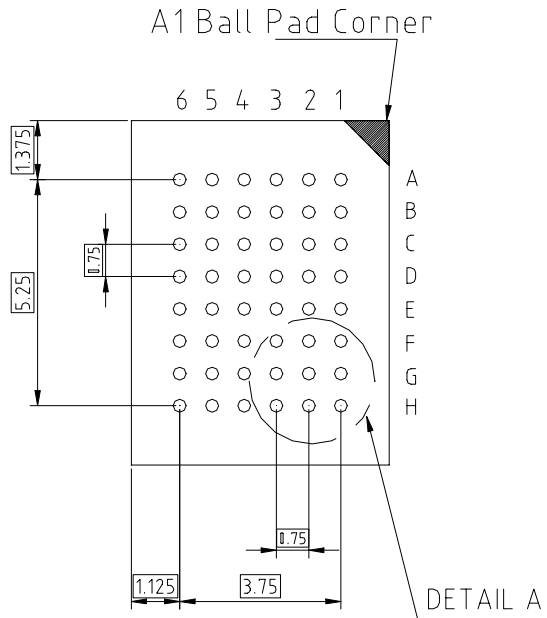

BOTTOM VIEW (BALL SIDE)

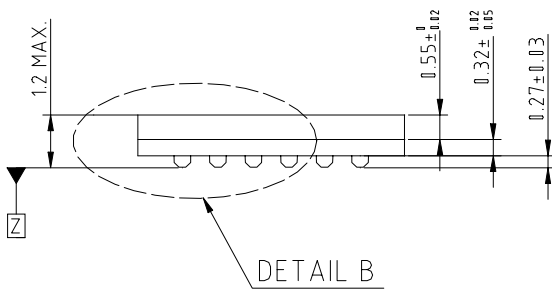

SIDE VIEW

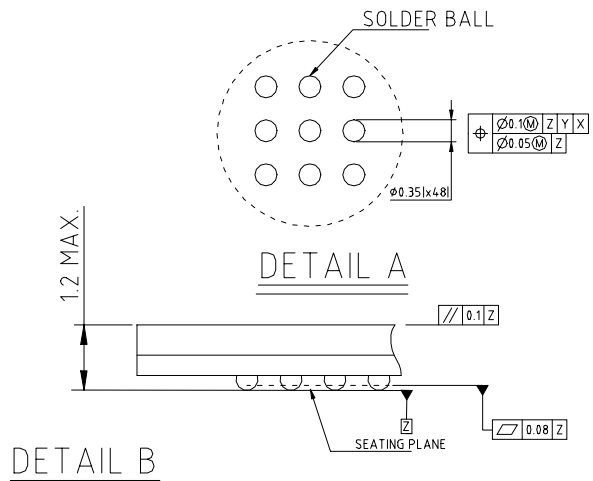



UTRON

UT62L12916/UT62L12916(I)

Rev. 1.0

128K X 16 BIT LOW POWER CMOS SRAM

ORDERING INFORMATION

COMMERCIAL TEMPERATURE

PART NO.	ACCESS TIME (ns)	STANDBY CURRENT (μ A) typ.	PACKAGE
UT62L12916BS-55L	55	20	48 PIN BGA
UT62L12916BS-55LL	55	2	48 PIN BGA
UT62L12916BS-70L	70	20	48 PIN BGA
UT62L12916BS-70LL	70	2	48 PIN BGA
UT62L12916BS-100L	100	20	48 PIN BGA
UT62L12916BS-100LL	100	2	48 PIN BGA

INDUSTRIAL TEMPERATURE

PART NO.	ACCESS TIME (ns)	STANDBY CURRENT (μ A) typ.	PACKAGE
UT62L12916BS-55LI	55	20	48 PIN BGA
UT62L12916BS-55LLI	55	2	48 PIN BGA
UT62L12916BS-70LI	70	20	48 PIN BGA
UT62L12916BS-70LLI	70	2	48 PIN BGA
UT62L12916BS-100LI	100	20	48 PIN BGA
UT62L12916BS-100LLI	100	2	48 PIN BGA

ORDERING INFORMATION (for lead free product)

COMMERCIAL TEMPERATURE

PART NO.	ACCESS TIME (ns)	STANDBY CURRENT (μ A) typ.	PACKAGE
UT62L12916BSL-55L	55	20	48 PIN BGA
UT62L12916BSL-55LL	55	2	48 PIN BGA
UT62L12916BSL-70L	70	20	48 PIN BGA
UT62L12916BSL-70LL	70	2	48 PIN BGA
UT62L12916BSL-100L	100	20	48 PIN BGA
UT62L12916BSL-100LL	100	2	48 PIN BGA

INDUSTRIAL TEMPERATURE

PART NO.	ACCESS TIME (ns)	STANDBY CURRENT (μ A) typ.	PACKAGE
UT62L12916BSL-55LI	55	20	48 PIN BGA
UT62L12916BSL-55LLI	55	2	48 PIN BGA
UT62L12916BSL-70LI	70	20	48 PIN BGA
UT62L12916BSL-70LLI	70	2	48 PIN BGA
UT62L12916BSL-100LI	100	20	48 PIN BGA
UT62L12916BSL-100LLI	100	2	48 PIN BGA



Rev. 1.0

UTRON

UT62L12916/UT62L12916(I)
128K X 16 BIT LOW POWER CMOS SRAM

THIS PAGE IS LEFT BLANK INTENTIONALLY.