

1.85 inch (47.0mm)

8X8 DOT MATRIX LED DISPLAY UVP-2688/2788 SERIES

DESCRIPTION

The UVP-2688/2788 is 1.85 inch (47.0mm) height 8X8 dot matrix display.
Single color displays have the choices of three bright colors-AlGaAs red/green/yellow.
Multicolor displays are applicable to two bright colors:green and red orange
All device have black face and white dot.
The AlGaAs red LED chip are made from AlGaAs on a non-transparent GaAs substrate.
The green LED chip are made from GaP on a transparent GaP substrate.
The yellow and red orange LED chip are made from GaAsP on a transparent GaP substrate.

FEATURES

- Industry standard size
- Wide viewing angle
- Continuous uniform dot matrix.
- Excellent characters appearance
- Low power requirement

DEVICES

PART NO.	DESCRIPTION	PACKAGE DIMENSION	INTERNAL CIRCUIT DIAGRAM
UVP-2688	Column Anode	Fig. 1	Fig. 2
UVP-2788	Column Anode		

ABSOLUTE MAXIMUM RATINGS

@ T_A=25°C

PARAMETER	AlGaAs RED	GREEN	YELLOW	RED ORANGE	UNIT
Power Dissipation Per Dot	36	36	32	36	mW
Peak Forward Current Per Dot	125	100	80	100	mA
Continuous Forward Current Per Dot	15	13	10	13	mA
Derating Linear From 25°C Per Dot	0.20	0.17	0.12	0.17	mA/°C
Reverse Voltage Per Dot	5	5	5	5	V
Operating Temperature Range	-35°C to +85°C				
Storage Temperature Range	-35°C to +85°C				
Solder Temperature 1/16 inch Below Seating Plane for 3 Seconds at 260°C					



1.85 inch (47.0mm)

8X8 DOT MATRIX LED DISPLAY

UVP-2688/2788 SERIES

PACKAGE DIMENSIONS

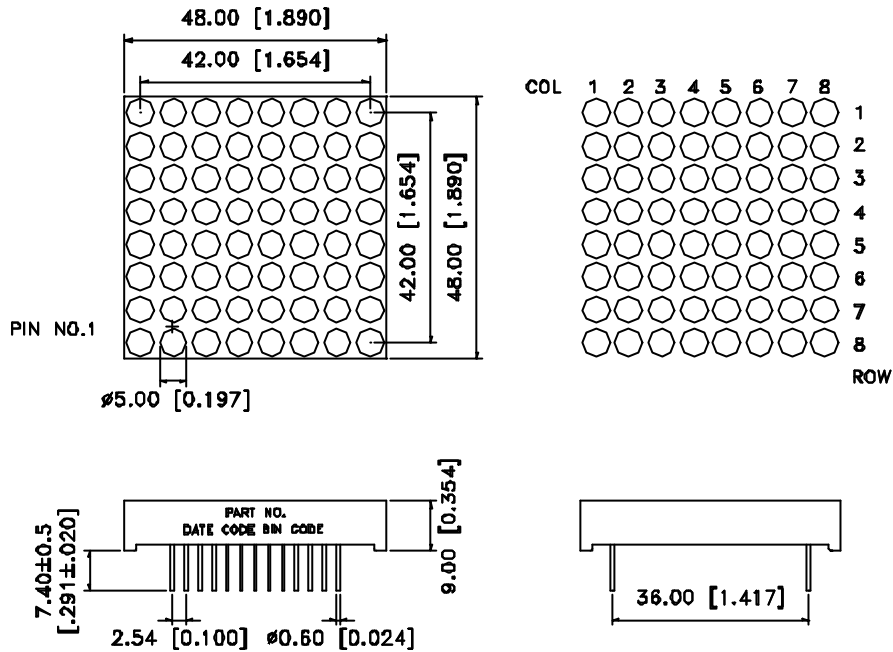

Unit:mm(Inches)

Tolerance is ± 0.25mm(0.01")unless otherwise noted

INTERNAL CIRCUIT DIAGRAM

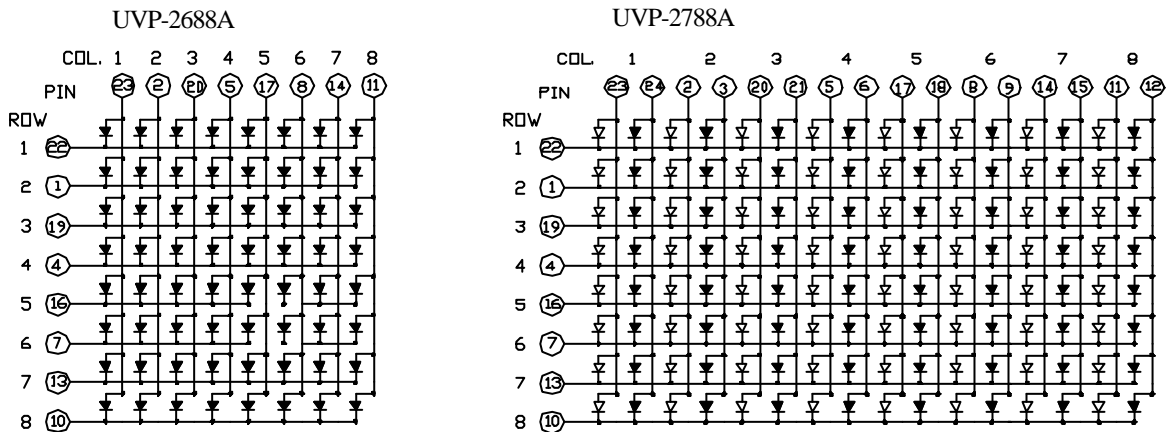

Fig. 2



Unity Opto Technology Co., Ltd.

11/14/2000

1.85 inch (47.0mm)

8X8 DOT MATRIX LED DISPLAY UVP-2688/2788 SERIES

PIN CONNECTION

PIN	CONNECTION	
	UVP-2688	UVP-2788
1	CATHODE ROW 2	CATHODE ROW 2
2	ANODE COL. 2	ANODE COL. 2G
3	NO PIN	ANODE COL. 2E
4	CATHODE ROW 4	CATHODE ROW 4
5	ANODE COL. 4	ANODE COL. 4G
6	NO PIN	ANODE COL. 4E
7	CATHODE ROW 6	CATHODE ROW 6
8	ANODE COL. 6	ANODE COL. 6G
9	NO PIN	ANODE COL. 6E
10	CATHODE ROW 8	CATHODE ROW 8
11	ANODE COL. 8	ANODE COL. 8G
12	NO PIN	ANODE COL. 8E
13	CATHODE ROW 7	CATHODE ROW 7
14	ANODE COL. 7	ANODE COL. 7G
15	NO PIN	ANODE COL. 7E
16	CATHODE ROW 5	CATHODE OW 5
17	ANODE COL. 5	ANODE COL. 5G
18	NO PIN	ANODE COL. 5E
19	CATHODE ROW 3	CATHODE ROW 3
20	ANODE COL. 3	ANODE COL. 3G
21	NO PIN	ANODE COL. 3E
22	CATHODE ROW 1	CATHODE ROW 1
23	ANODE CO. 1	ANODE COL. 1G
24	NO PIN	ANODE COL. 1E

1.85 inch (47.0mm)

8X8 DOT MATRIX LED DISPLAY

UVP-2688/2788 SERIES

ELECTRICAL/OPTICAL CHARACTERISTICS

AlGaAs RED (UVP-2688AC)

@ T_A=25°C

PARAMETER	SYMBOL	MIN.	TYP.	MAX.	UNIT	TEST CONDITION
Average Luminous Intensity	I _V	6300	12000		μcd	I _p = 80 mA 1/16 Duty
Peak Emission Wavelength	λ _p /Hue		660/638		nm	I _F = 20 mA
Spectral Line Half-Width	Δλ		35		nm	I _F = 20 mA
Forward Voltage, any Dot	V _F		1.8	2.4	V	I _F = 20 mA
Reverse Current, any Dot	I _R			100	μA	V _R = 5 V
Luminous Intensity Matching Ratio	I _V -m			2:1		I _F = 10 mA

GREEN (UVP-2688AG) & (UVP-2788AA GREEN)

@ T_A=25°C

PARAMETER	SYMBOL	MIN.	TYP.	MAX.	UNIT	TEST CONDITION
Average Luminous Intensity	I _V	1780	4800		μcd	I _p = 80 mA 1/16 Duty
Peak Emission Wavelength	λ _p /Hue		565/569		nm	I _F = 20 mA
Spectral Line Half-Width	Δλ		30		nm	I _F = 20 mA
Forward Voltage, any Dot	V _F		2.1	2.6	V	I _F = 20 mA
Reverse Current, any Dot	I _R			100	μA	V _R = 5 V
Luminous Intensity Matching Ratio	I _V -m			2:1		I _F = 10 mA

YELLOW (UVP-2688AY)

@ T_A=25°C

PARAMETER	SYMBOL	MIN.	TYP.	MAX.	UNIT	TEST CONDITION
Average Luminous Intensity	I _V	1780	4800		μcd	I _p = 80 mA 1/16 Duty
Peak Emission Wavelength	λ _p /Hue		585/588		nm	I _F = 20 mA
Spectral Line Half-Width	Δλ		35		nm	I _F = 20 mA
Forward Voltage, any Dot	V _F		2.1	2.6	V	I _F = 20 mA
Reverse Current, any Dot	I _R			100	μA	V _R = 5 V
Luminous Intensity Matching Ratio	I _V -m			2:1		I _F = 10 mA

RED ORANGE (UVP-2788AA RED ORANGE)

@ T_A=25°C

PARAMETER	SYMBOL	MIN.	TYP.	MAX.	UNIT	TEST CONDITION
Average Luminous Intensity	I _V	1780	4800		μcd	I _p = 80 mA 1/16 Duty
Peak Emission Wavelength	λ _p /Hue		630/621		nm	I _F = 20 mA
Spectral Line Half-Width	Δλ		40		nm	I _F = 20 mA
Forward Voltage, any Dot	V _F		2.0	2.6	V	I _F = 20 mA
Reverse Current, any Dot	I _R			100	μA	V _R = 5 V
Luminous Intensity Matching Ratio	I _V -m			2:1		I _F = 10 mA



1.2 inch (30.42mm)

5X7 DOT MATRIX LED DISPLAY

UVP-2688/2788 SERIES

TYPICAL ELECTRICAL/OPTICAL CHARACTERISTIC CURVES

(Ambient Temperature =25°C Unless Otherwise Noted)

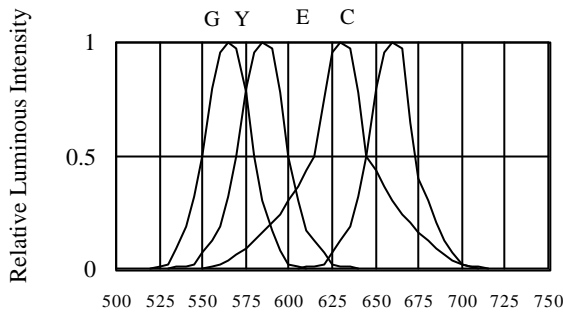

Fig 1. RELATIVE LUMINOUS INTENSITY VS. WAVELENGTH

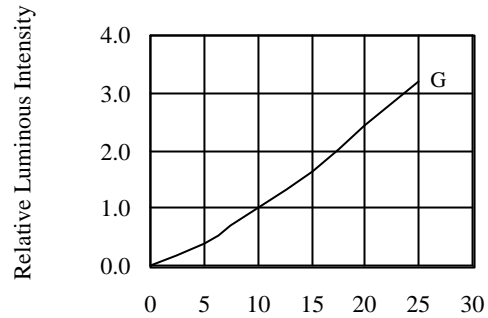

Fig 2. RELATIVE LUMINOUS INTENSITY VS. FORWARD CURRENT

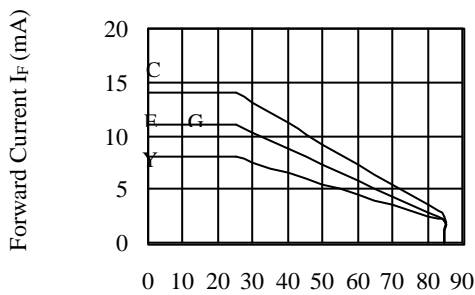

Fig 3. ALLOWABLE DC CURRENT VS. AMBIENT TEMPERATURE

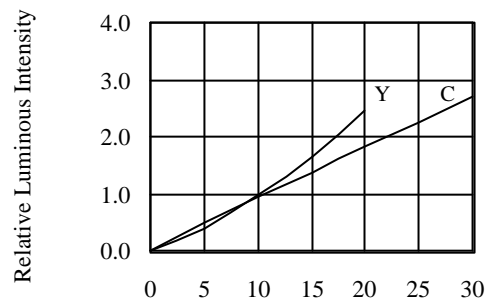

Fig 4. RELATIVE LUMINOUS INTENSITY VS. FORWARD CURRENT

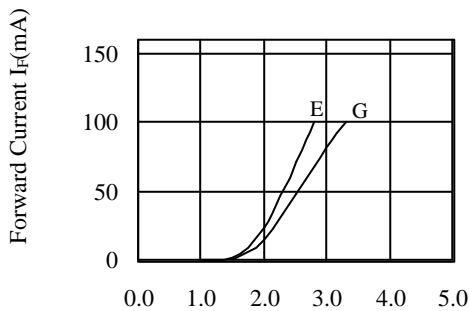

Fig 5. FORWARD CURRENT VS. FORWARD VOLTAGE

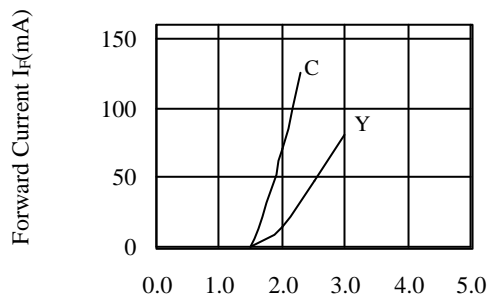

Fig 6. FORWARD CURRENT VS. FORWARD VOLTAGE