

# 0.787 inch ( 20.0mm ) 8X8 DOT MATRIX LED DISPLAY

# UVP-7188 X SERIES

## DESCRIPTION

The UVP-7188 X SERIES is 0.787 inch ( 20.0mm) height 8X8 dot matrix display.

Single color display have the choices of three bright colors-amber/green/red orange.

Multicolor display are applicable to two colors : green and red (

All device have gray face and white dot.

A26 The green LED chip are made from GaP on a transparent GaP substrate.

The red orange and amber LED chip are made from GaAsP on a transparent GaP substrate.

## FEATURES

- Industuy standard size
- Wide viewing angle
- Continuous uniform dot matrix.
- Excellent characters appearance
- Low power requirement

## DEVICES

PART NO.	DESCRIPTION	PACKAGE DIMENSION	INTERNAL CIRCUIT DIAGRAM
UVP-7188	Column Cathode	Fig. 1	Fig. 2

## ABSOLUTE MAXIMUM RATINGS

@ T<sub>A</sub>=25°C

PARAMETER	AMBER	GREEN	RED ORANGE	UNIT
Power Dissipation Per Dot	32	32	32	mW
Peak Forward Current Per Dot	90	90	90	mA
Continuous Forward Current Per Dot	11	11	11	mA
Derating Linear From 25°C Per Dot	0.15	0.15	0.15	mA/°C
Reverse Voltage Per Dot	5	5	5	V
Operating Temperature Range	-35°Cto+85°C			
Storage Temperature Range	-35°Cto+85°C			
Solder Temperature 1/16 inch Below Seating Plane for 3 Seconds at 260°C				

0.787 inch ( 20.0mm )

8X8 DOT MATRIX LED DISPLAY

UVP-7188 X SERIES

PACKAGE DIMENSIONS

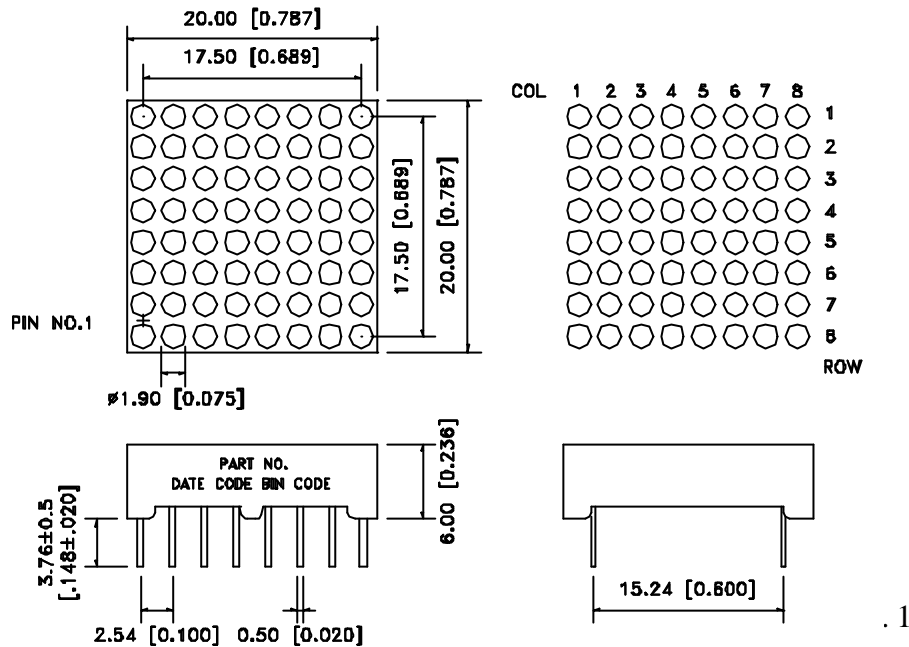

Unit:mm(inches)

Tolerance is ± 0.25mm(0.01")unless otherwise noted

INTERNAL CIRCUIT DIAGRAM

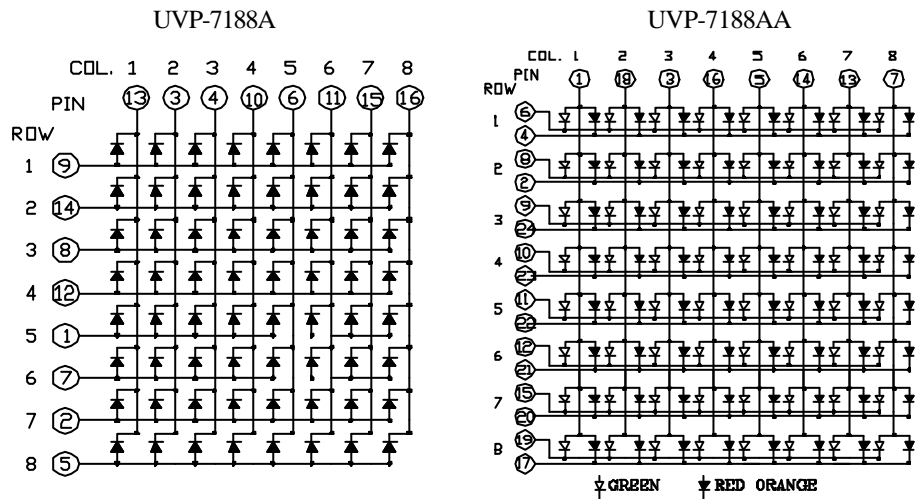

Fig. 2

**0.787 inch ( 20.0mm )  
8X8 DOT MATRIX LED DISPLAY**

**UVP-7188 X SERIES**

**PIN CONNECTION**

PIN	UVP-7188AA		
	CONNECTION	PIN	CONNECTION
1	ANODE COL. 1	13	ANODE COL. 7
2	CATHODE ROW 2 (R)	14	ANODE COL. 6
3	ANODE COL. 3	15	CATHODE ROW 7 (G)
4	CATHODE ROW 1 (R)	16	ANODE COL. 4
5	ANODE COL. 5	17	CATHODE ROW 8 (R)
6	CATHODE ROW 1 (G)	18	ANODE COL. 2
7	ANODE COL. 8	19	CATHODE ROW 8 (G)
8	CATHODE ROW 2 (G)	20	CATHODE ROW 7 (R)
9	CATHODE ROW 3 (G)	21	CATHODE ROW 6 (R)
10	CATHODE ROW 4 (G)	22	CATHODE ROW 5 (R)
11	CATHODE ROW 5 (G)	23	CATHODE ROW 4 (R)
12	CATHODE ROW 6 (G)	24	CATHODE ROW 3 (R)

**PIN CONNECTION**

PIN	UVP-7188		
	CONNECTION	PIN	CONNECTION
1	ANODE ROW 5	9	ANODE ROW 1
2	ANODE ROW 7	10	CATHODE COL. 4
3	CATHODE COL. 2	11	CATHODE COL. 6
4	CATHODE COL. 3	12	ANODE ROW 4
5	ANODE ROW 8	13	CATHODE COL. 1
6	CATHODE COL. 5	14	ANODE ROW 2
7	ANODE ROW 6	15	CATHODE COL. 7
8	ANODE ROW 3	16	CATHODE COL. 8

**0.787 inch ( 20.0mm )**

**8X8 DOT MATRIX LED DISPLAY**

**UVP-7188 X SERIES**

**ELECTRICAL/OPTICAL CHARACTERISTICS**

**Anber (UVP-7188A)**

@ T<sub>A</sub>=25°C

PARAMETER	SYMBOL	MIN.	TYP.	MAX.	UNIT	TEST CONDITION
Average Luminous Intensity	I <sub>V</sub>	630	2000		μcd	I <sub>p</sub> = 80 mA 1/16 Duty
Peak Emission Wavelength	λ <sub>p</sub> /Hue		610/602		nm	I <sub>F</sub> = 20 mA
Spectral Line Half-Width	Δλ		35		nm	I <sub>F</sub> = 20 mA
Forward Voltage, any Dot	I <sub>R</sub>				V	I <sub>F</sub> = 21 mA
Reverse Current, any Dot					μA	V <sub>R</sub> = 5 V
Luminous Intensity Matching Ratio	I <sub>V</sub> -m			2:1		I <sub>F</sub> = 10 mA

**GREEN (UVP-7188G) & (UVP-7188AA GREEN)**

@ T<sub>A</sub>=25°C

PARAMETER	SYMBOL	MIN.	TYP.	MAX.	UNIT	TEST CONDITION
Average Luminous Intensity	I <sub>V</sub>	630	2000		μcd	I <sub>p</sub> = 80 mA 1/16 Duty
Peak Emission Wavelength	λ <sub>p</sub> /Hue		565/569		nm	I <sub>F</sub> = 20 mA
Spectral Line Half-Width	Δλ		35		nm	I <sub>F</sub> = 20 mA
Forward Voltage, any Dot	V <sub>F</sub>		2.1	2.6	V	I <sub>F</sub> = 20 mA
Reverse Current, any Dot	I <sub>R</sub>			100	μA	V <sub>R</sub> = 5 V
Luminous Intensity Matching Ratio	I <sub>V</sub> -m			2:1		I <sub>F</sub> = 10 mA

**RED ORANGE (UVP-7188E) & (UVP-7188AA RED ORANGE)**

@ T<sub>A</sub>=25°C

PARAMETER	SYMBOL	MIN.	TYP.	MAX.	UNIT	TEST CONDITION
Average Luminous Intensity	I <sub>V</sub>	630	2000		μcd	I <sub>p</sub> = 80 mA 1/16 Duty
Peak Emission Wavelength	λ <sub>p</sub> /Hue		630/621		nm	I <sub>F</sub> = 20 mA
Spectral Line Half-Width	Δλ		35		nm	I <sub>F</sub> = 20 mA
Forward Voltage, any Dot	V <sub>F</sub>		2.0	2.6	V	I <sub>F</sub> = 20 mA
Reverse Current, any Dot	I <sub>R</sub>			100	μA	V <sub>R</sub> = 5 V
Luminous Intensity Matching Ratio	I <sub>V</sub> -m			2:1		I <sub>F</sub> = 10 mA

0.787 inch ( 20.0mm )

8X8 DOT MATRIX LED DISPLAY

UVP-7188 X SERIES

TYPICAL ELECTRICAL/OPTICAL CHARACTERISTIC CURVES

( Ambient Temperature =25°C Unless Otherwise Noted )

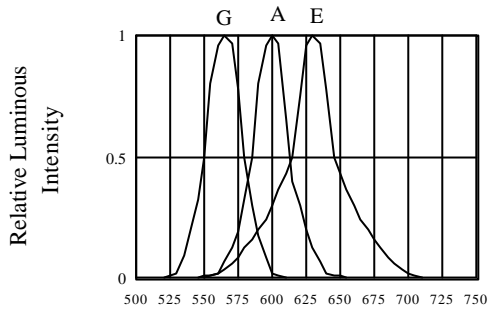

FIG.1 RELATIVE LUMINOUS INTENSITY VS. WAVELENGTH

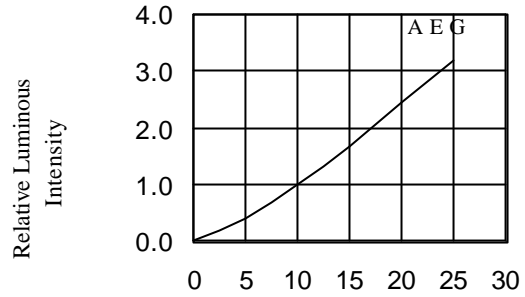

FIG.2 RELATIVE LUMINOUS INTENSITY VS. FORWARD CURRENT

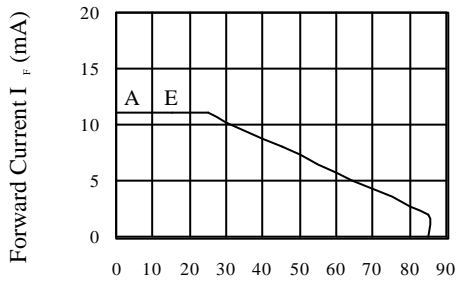

FIG.3 ALLOWABLE DC CURRENT VS. AMBIENT TEMPERATURE

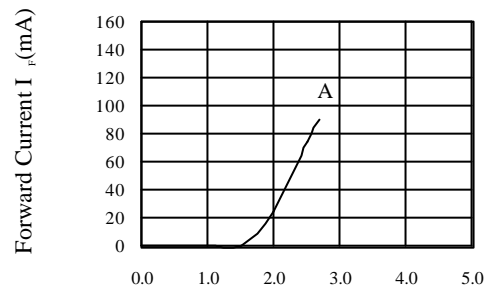

FIG.4 FORWARD CURRENT VS. FORWARD VOLTAGE

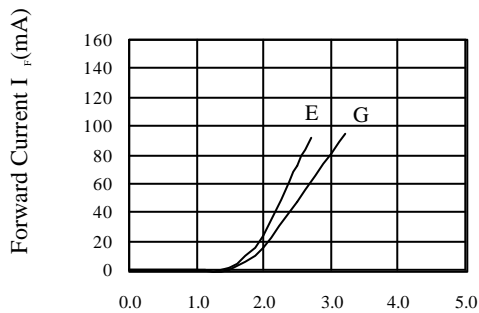

FIG.4 FORWARD CURRENT VS. FORWARD VOLTAGE